



ASIA

Delta Electronics, Inc.

Taoyuan1

31-1, Xingbang Road, Guishan Industrial Zone,
Taoyuan County 33370, Taiwan, R.O.C.
TEL: 886-3-362-6301 / FAX: 886-3-362-7267

Delta Electronics (Jiang Su) Ltd.

Wujiang Plant3

1688 Jiangxing East Road,
Wujiang Economy Development Zone,
Wujiang City, Jiang Su Province,
People's Republic of China (Post code: 215200)
TEL: 86-512-6340-3008 / FAX: 86-769-6340-7290

Delta Electronics (Japan), Inc.

Tokyo Office

Delta Shibadaimon Building, 2-1-14 Shibadaimon,
Minato-Ku, Tokyo, 105-0012, Japan
TEL: 81-3-5733-1111 / FAX: 81-3-5733-1211

Delta Electronics (Korea), Inc.

Donghwa B/D 3F, 235-6, Nonhyun-dong,
Kangnam-gu, Seoul 135-010, Korea
TEL: 82-2-515-5303/5 / FAX: 82-2-515-5302

Delta Electronics (Singapore) Pte. Ltd.

8 Kaki Bukit Road 2, #04-18 Ruby Warehouse Complex,
Singapore 417841
TEL: 65-6747-5155 / FAX: 65-6744-9228

Delta Energy Systems (India) Pvt. Ltd.

Plot No. 27 & 31, Sector-34, EHTP,
Gurgaon-122001 Haryana, India
TEL: 91-124-4169040 / FAX: 91-124-4036045

AMERICA

Delta Products Corporation (USA)

Raleigh Office

P.O. Box 12173, 5101 Davis Drive,
Research Triangle Park, NC 27709, U.S.A.
TEL: 1-919-767-3813 / FAX: 1-919-767-3969

EUROPE

Deltronics (The Netherlands) B.V.

Eindhoven Office

De Witbogt 15, 5652 AG Eindhoven, The Netherlands
TEL: 31-40-2592850 / FAX: 31-40-2592851

*We reserve the right to change the information in this catalogue without prior notice



ASDA-A

DELTA ASDA-A AC Servo System



AC Servo System



Features

Complete Functionality

Suitable for wide variety of applications

Modbus communication control
Position/Speed/Torque modes
Dual control modes
Internal single-axis position control
PG dividing ratio output
Protection function

Multi-groups of electronic gear
External JOG function
Speed / Torque limit operation
Flexible digital inputs / outputs
Onboard numeric display and keypad
Fault display

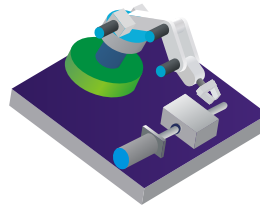

Excellent Performance

High speed DSP! Rapid performance achieved!

Motor settling time below 1ms
Speed responsiveness characteristic: 450Hz
Great stability and performance at low speed:
less than 0.5% error at 1 rpm per rotation
10ms accel. time from running without load
-3000 rpm to 3000 rpm

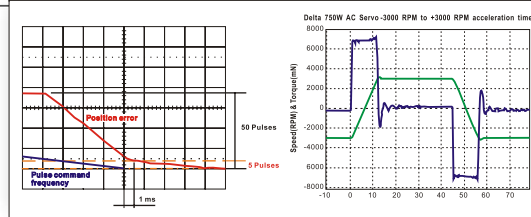

Powerful Position Control Function Built-in

Eliminate External Controller

Point-to-Point single axis control
8 internal memorized position settings
Move to Home function
Position teaching capability

Absolute and Incremental encoder
User-definable Accel. / Decel. Curve
Feed step control function
Internal auto-running control mode

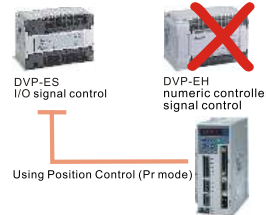

Smoothing Strategy

S curve profile for speed mode P curve profile for position mode

In position / Speed mode, smoothing curves are provided for stability improvement with high accuracy.

Using smoothing curves can run the motor more smoothly in response to a sudden operation command. Efficiently improve machinery performance and extend the life of machinery system.

When operation commands are suddenly changed, the user can use smoothing curves to achieve continuous and stable performance no matter the motor is accelerating or decelerating.

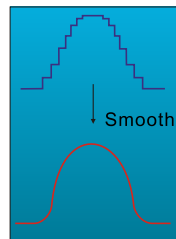

Tuning Technology

Robust for high speed load inertia change

Easy Mode
Robust control for continuous and wide range of load inertia change, with 16 levels of system stiffness and responsiveness

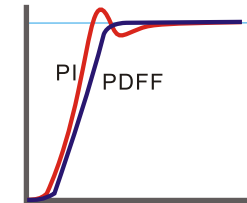

Auto-tuning for low speed load inertia change

Auto Mode
Auto-tuning control for loop gains adjustment according to measured external load inertia, with 16 levels of system responsiveness. Easy to find the correct inertia value and meet the requirements of high precision and high responsiveness.

Flexible and competent for belt and screw transmission mechanism

PDF Mode (PDF Pseudo-Derivative Feedback and Feedforward)

Only enter speed responsiveness, and it can set the corresponding internal parameters automatically according to the measured load inertia value. Faster responsiveness with no overshoot and better suppression and compensation capability against interference and noise emission.

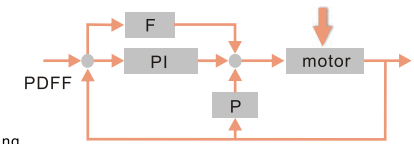

Modbus Communication

Built-in RS-232 / RS-485 / RS-422 interface

Direct connectivity to the control equipment and communication interface provides effortless and versatile operation. Capable of multi-axis synchronous connection and qualified to accomplish monitoring control, I/O access and reading/writing parameters.



Resonant Suppression Capability

Superior resonant suppression capability enhance system responsiveness

Loss pass and notch filters can efficiently suppress and control the mechanical resonant and in the meantime make the machinery system work normally when system responsiveness is still very high.

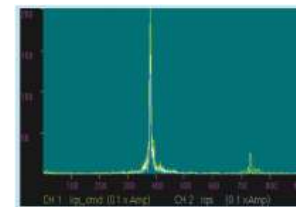

Current waveform before resonant suppression

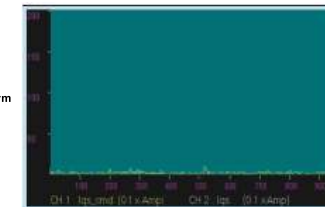

Current waveform after resonant suppression

AC Servo System

Features

Window based Software

Operation is child's play.

Parameter management

- Clear parameters classification. Easy to view
- Detailed parameters explanation. Easy to understand.
- Real-time parameters setting. Fast and convenient.
- Complete read and write function



System Block Diagram

- Quick and simply to understand system structure
- Promptly acknowledge the relevant parameters in different control mode

Calculation Tool

According to the mechanical moving distance calculate the corresponding internal pulse number automatically

Many auxiliary functions

Software selectable virtual I/O

User-definable I/O points
Virtual software "I/O switch" button

Digital oscilloscope feature

Graphical display of internal signals, similar to a digital oscilloscope
Quickly show and record drive status.
On-line monitoring is uncomplicated.

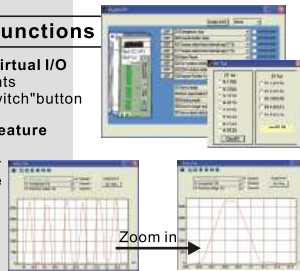

JOG mode and Position Teaching function

Reach and save the user-desired position through JOG operation.

Drive all status monitor function available.

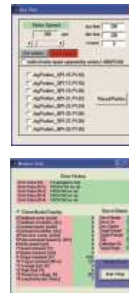

Single-axis Control Function

Feed step control

PC-based controller and PLC can achieve feed step control, torque auto reduction and position error clear function via communication or DI/DO signals. Feed step control function can greatly reduce the power consumption and improve the motor overheat problem caused by the mechanical engagement error during positioning.

Main applications: Turret control machinery, Cutting tool processing, feeding and assembly system

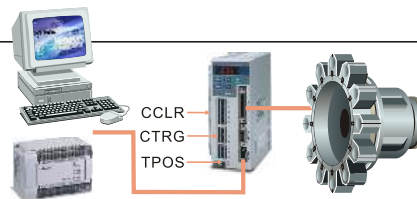

Single-axis positioning control

Built-in 8 position commands and 8 corresponding moving speed settings. When using communication control, it can change internal command and moving speed dynamically. Position control with unlimited numbers of points via communication is possible.

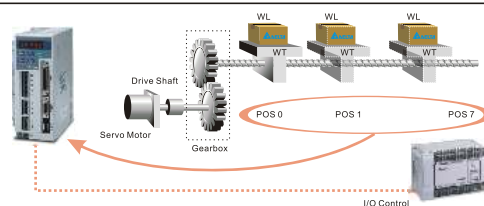

Model Explanation

Servo Drive ASDA-A Series

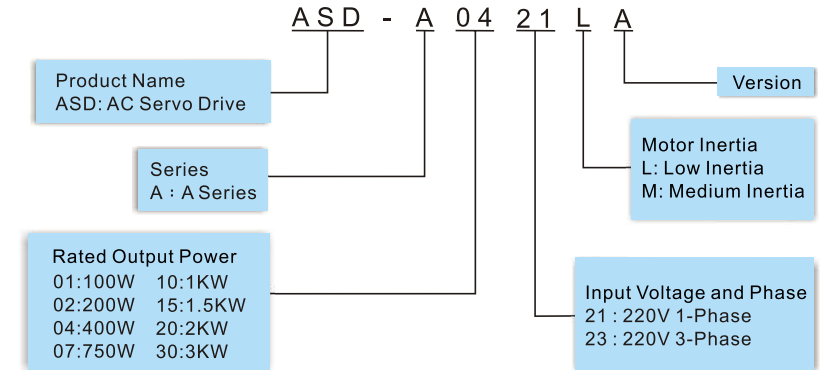

Servo Motor Series

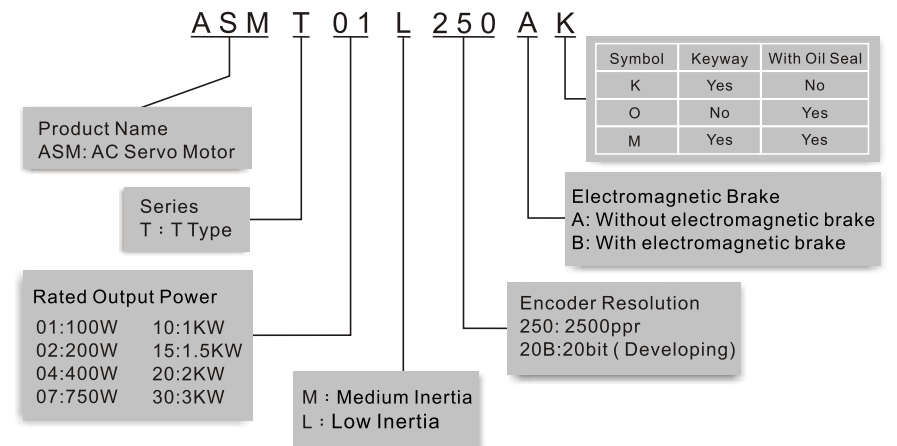

AC Servo System

Configuration



Servo Drive and Servo Motor Combinations

		Servo Drive	Servo Motor
Low Inertia	100W	ASD-A0121LA	ASMT01L250□□
	200W	ASD-A0221LA	ASMT02L250□□
	400W	ASD-A0421LA	ASMT04L250□□
	750W	ASD-A0721LA	ASMT07L250□□
	1000W	ASD-A1021LA	ASMT10L250□□
	2000W	ASD-A2023LA	ASMT20L250□□
	3000W	ASD-A3023LA	ASMT30L250□□

		Servo Drive	Servo Motor
Medium Inertia	1000W	ASD-A1021MA	ASMT10M250□□
	1500W	ASD-A1521MA	ASMT15M250□□
	2000W	ASD-A2023MA	ASMT20M250□□
	3000W	ASD-A3023MA	ASMT30M250□□

Note: The boxes(□) at the ends of the model names are for version or options.

System Configuration

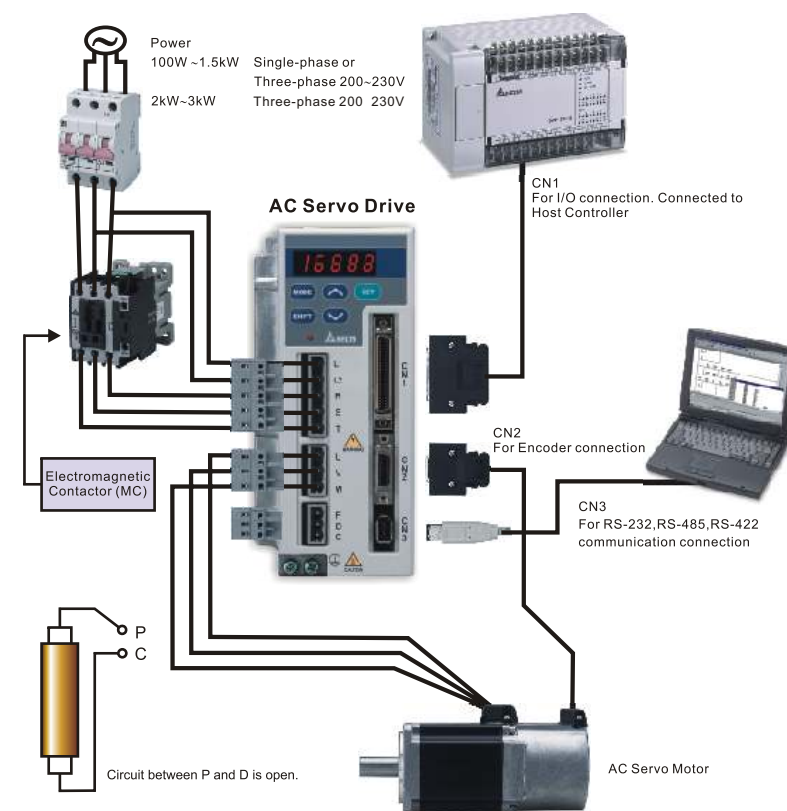

Note:

1. Check if the power supply and wiring of R, S, T and L1, L2 is correct.
2. Check if the wiring of U, V, W is correct.
3. When using is disconnected to P and C, make sure the circuit between P and D is open. When using internal regenerative resistor, make sure the circuit between P and D is close and the circuit between P and C is open.
4. If an alarm displays or an emergency stop occurs, turn the electromagnetic contactor off by using ALRM output to force the motor to stop.

AC Servo System

Standard Connection Examples



Position (Pt) Control Mode

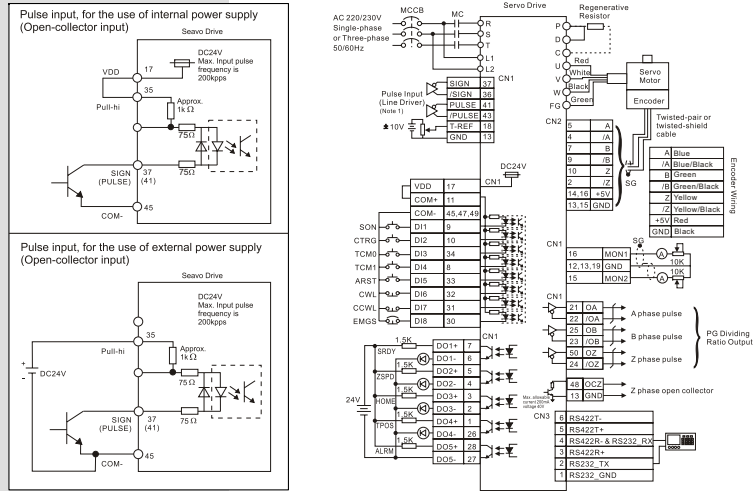

Speed (S) Control Mode

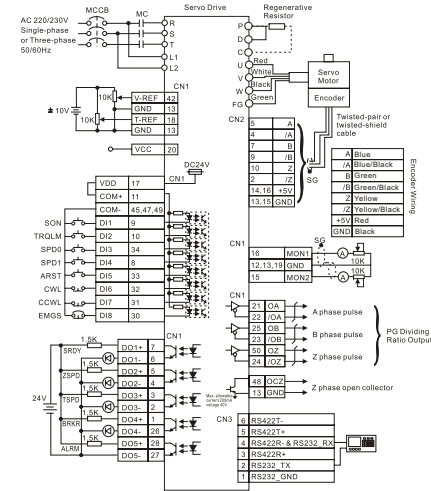

Position (Pr) Control Mode

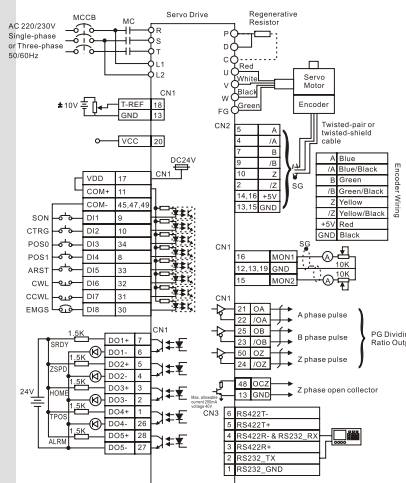

Torque (T) Control Mode

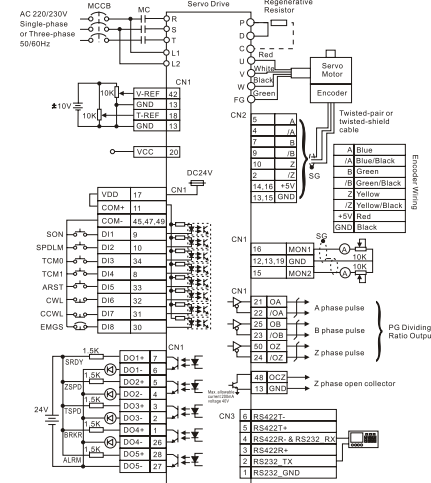

AC Servo System

ASDA-A

Servo Drive Specifications (ASDA-A Series)

Model: ASDA-A□□□□□□		01	02	04	07	10	15	20	30	
Power supply	Phase / Voltage	Three-phase or Single-phase 220VAC							Three-phase 220VAC	
	Permissible Voltage Range	Three-phase: 170~255VAC Single-phase: 200~255VAC							170~255VAC	
	Permissible Frequency Range	50 / 60 Hz ± 5%								
Cooling System	Natural Air Circulation				Fan Cooling					
Encoder Resolution / Feedback Resolution	2500ppr/10000ppr									
Control of Main Circuit	SVPWM Control									
Tuning Modes	Easy / Auto / Manual									
Dynamic Brake	Built-in									
Power supply	Max. Input Pulse Frequency	Max. 500KPPS (Line driver) / Max. 200KPPS (Open collector)								
	Pulse Type	Pulse + Direction, A phase + B phase, CCW pulse + CW pulse								
	Command Source	External pulse train / Internal parameters								
	Smoothing Strategy	Low-pass and P-curve filter								
	Electronic Gear	Electronic gear N/M multiple N: 1~32767, M: 1:32767(1/50<N/M<200)								
	Torque Limit Operation	Set by parameters								
	Feed Forward Compensation	Set by parameters								
Position Control Mode	Analog Input Command	Voltage Range	0~±10 VDC							
		Input Resistance	10K Ω							
		Time Constant	2.2 μs							
	Speed Control Range ¹	1:5000								
	Command Source	External analog signal / Internal parameters								
	Smoothing Strategy	Low-pass and S-curve filter								
	Torque Limit Operation	Set by parameters or via Analog input								
	Responsiveness Characteristic	Maximum 450Hz								
	Speed Fluctuation Rate ²	0.01% or less at load fluctuation 0 to 100% (at rated speed)								
		0.01% or less at power fluctuation ±10% (at rated speed)								
0.01% or less at ambient temperature fluctuation 0°C to 50°C (at rated speed)										
Speed Control Mode	Analog Input Command	Voltage Range	0~±10 VDC							
		Input Resistance	10K Ω							
		Time Constant	2.2 μs							
	Permissible Time for Overload	8 sec. Under 200% rated output								
	Command Source	External analog signal / Internal parameters								
	Smoothing Strategy	Low-pass filter								
Speed Limit Operation	Parameter Setting or via Analog input									
Analog Monitor Output	Monitor signal can set by parameters (Output voltage range: ±8V)									
Digital Input/Output	Input	Servo On, Reset, Gain switching, Pulse clear, Low speed CLAMP, Speed/Torque limit enabled, Emergency stop, Forward / Reverse inhibit limit, Pulse inhibit input, Forward / Reverse JOG input								
		Internal parameter selection, Torque limit activation, Speed limit activation, Control mode selection (Position / Speed / Torque mode selection, Dual mode selection), Feed step control mode, Internal auto running mode, Electronic gear ratio selection								
Output	Encoder signal output (A, B, Z Line Driver / Z Open collector)									
	Servo ready, Servo On, Zero speed, Speed reached, Positioning completed, At torques limit, Servo alarm output (Servo fault), Electromagnetic brake, Home completed									
Protective Functions	Overcurrent, Overvoltage, Undervoltage, Motor overheated, Regeneration error, Overload, Overspeed, Abnormal pulse control command, Excessive deviation, Watch dog execution time out, Encoder error, Adjustment error, Emergency stop activated, Reverse/ Forward limit switch error, IGBT temperature error, Memory error, DSP communication error, Serial communication error, Input power phase loss, Serial communication time out, Command write-in error									
Communication Interface	RS-232/RS-485/RS-422									
Environment	Installation Site	Indoor location (free from direct sunlight), no corrosive liquid and gas (far away from oil mist, flammable gas, dust)								
	Altitude	Altitude 1000m or lower above sea level								
	Atmospheric pressure	86kPA to 106kPA								
	Operating Temperature	0°C to 55°C (If operating temperature is above specified range, forced cooling will be required)								
	Storage Temperature	-20°C~65°C(-4°F~149°F)								
	Humidity	0 to 90% (non-condensing)								
	Vibration	9.80665m/s ² (1G) less than 20Hz, 5.88m/s ² (0.6G) 20 to 50Hz								
	Terminals with Short Circuit Protection	U, V, W, CN1, CN2, Cn3								
Power System	TN System ³									
Standards/Requirement	IEC / EN 61800-5-1, UI508, TUV, C-tick									

Low Inertia Servo Motor Specifications (ASMT□L Series)

Model: ASMT□□L250□□		100W	200W	400W	750W	1kW	2kW	3kW
		01	02	04	07	10	20	30
Specifications	Rated output power (kW)	0.1	0.2	0.4	0.75	1.0	2.0	3.0
	Rated torque (N.m)	0.318	0.64	1.27	2.39	3.3	6.8	9.5
	Maximum torque (N.m)	0.95	1.91	3.82	7.16	9.9	19.2	31.5
	Rated speed (rpm)	3000						
	Maximum speed (rpm)	5000			4500			
	Rated current (A)	1.1	1.7	3.3	5.0	6.8	13.4	17.5
	Maximum current (A)	3.0	4.9	9.3	14.1	18.7	38.4	55
	Power rating (kW/s)	34.5	23.0	48.7	51.3	42	98	95.1
	Rotor moment of inertia (Kg.m ²) (without brake)	0.03E-4	0.18E-4	0.34E-4	1.08E-4	2.6E-4	4.7E-4	11.6E-4
	Mechanical time constant (ms)	0.6	0.9	0.7	0.6	1.7	1.2	1.5
	Static friction torque (N.m)	0.02	0.04	0.04	0.08	0.49	0.49	0.49
	Torque constant-KT (N.m/A)	0.32	0.39	0.4	0.5	0.56	0.54	0.581
	Voltage constant-KE (V/rpm)	33.7E-3	41.0E-3	41.6E-3	52.2E-3	58.4E-3	57.0E-3	60.9E-3
	Armature resistance (Ohm)	20.3	7.5	3.1	1.3	2.052	0.765	0.32
	Armature inductance (mH)	32	24	11	6.3	8.4	3.45	2.63
	Electrical time constant (ms)	1.6	3.2	3.2	4.8	4.1	4.5	8.2
	Insulation class	Class F						
	Insulation resistance	DC 500V, 100M Ω以上						
	Insulation strength	AC 1500 V, 50 Hz, 60 sec						
	Max. radial shaft load (N)	78.4	196	196	343	490	490	490
Max. thrust shaft load (N)	39.2	68.6	68.6	98	98	98	98	
Vibration grade (um)	15							
DC brake power (V)	24±10%							
Rotor moment of inertia (Kg.m ²) (with brake)	0.06E-4	0.28E-4	0.44E-4	1.32E-4	3.1E-4	5.2E-4	14.39E-4	
Brake holding torque [N·m (min)]	0.32	1.27	1.27	2.55	9.3	9.3	13.5	
Brake power consumption (at 20 °C) [W]	5	9	9	9.5	17.9	17.9	30	
Brake release time [ms (Max)]	20	20	20	50	20	20	20	
Brake pull-in time [ms (Max)]	40	50	50	80	90	90	90	
Operating temperature	0°C to 40°C (32°F to 104°F)							
Storage temperature	-20°C to 70°C (-4°F to 158°F)							
Operating humidity	20 to 90%RH (non-condensing)							
Storage humidity	20 to 90%RH (non-condensing)							
Vibration capacity	2.5G							
Enclosure Rating	IP65 (except shaft and connector)							
Standards/Requirement	IEC60034-1, UI1004							



AC Servo System

Specifications



Speed-Torque Curves (ASMT □ L Series)

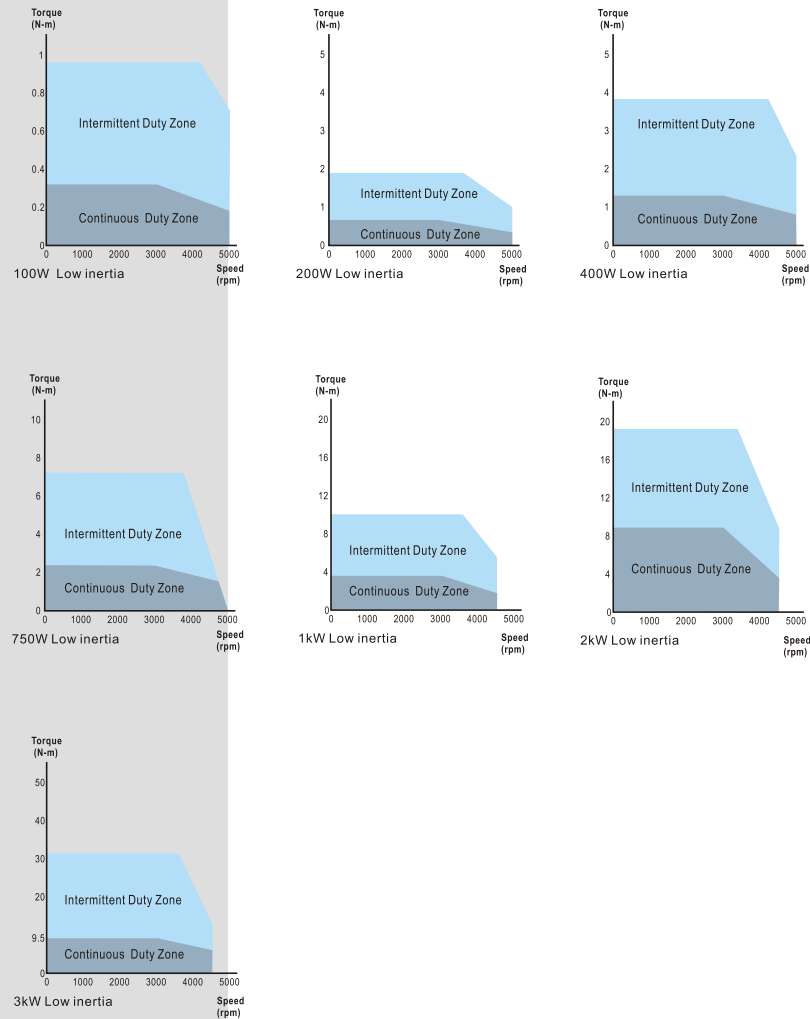

Medium Inertia Servo Motor Specifications (ASMT □ M Series)

Model: ASMT □ □ M250 □ □		1kW	1.5kW	2kW	3kW
		10	15	20	30
Specifications	Rated output power (kW)	1.0	1.5	2.0	3.0
	Rated torque (N.m)	4.8	7.16	9.4	14.3
	Maximum torque (N.m)	15.7	21.5	23.5	35.8
	Rated speed (rpm)	2000			
	Maximum speed (rpm)	3000			
	Rated current (A)	5.6	10.6	13.1	17.4
	Maximum current (A)	17.6	30.3	31.4	42.3
	Power rating (kW/s)	38.4	58.3	55.6	47.2
	Rotor moment of inertia (Kg.m ²) (without brake)	5.98E-4	8.79E-4	15.8E-4	43.3E-4
	Mechanical time constant (ms)	1.4	1.3	1.6	0.9
	Static friction torque (N.m)	0.29	0.5	0.98	0.98
	Torque constant-KT (N.m/A)	0.91	0.73	0.77	0.86
	Voltage constant-KE (V/rpm)	95.71E-3	76.0E-3	81.1E-3	90.5E-3
	Armature resistance (Ohm)	1.98	0.828	0.6	0.162
	Armature inductance (mH)	13.2	5.5	8.1	2.3
	Electrical time constant (ms)	6.7	6.6	10.1	14.2
	Insulation class	Class F			
	Insulation resistance	>100MΩ, DC 500V			
	Insulation strength	AC 1500 V, 50 Hz, 60 seconds			
	Max. radial shaft load (N)	490	490	784	784
Max. thrust shaft load (N)	98	98	392	392	
Vibration grade (μm)	15				
DC brake power (V)	24±10%				
Rotor moment of inertia (Kg.m ²) (with brake)	8.77E-4	11.57E-4	27.8E-4	56.3E-4	
Brake holding torque [N·m (min)]	7.5	10.5	32	50	
Brake power consumption (at 20 °C) [W]	20	30	34.7	40	
Brake release time [ms (Max)]	20	20	50	140	
Brake pull-in time [ms (Max)]	90	90	170	110	
Environment	Operating temperature	0°C to 40°C (32°F to 104°F)			
	Storage temperature	-20°C to 70°C (-4°F to 158°F)			
	Operating humidity	20~90%RH (non-condensing)			
	Storage humidity	20~90%RH (non-condensing)			
	Vibration capacity	2.5G			
	Enclosure Rating	IP65 (except shaft and connector)			
Standards/Requirement	IEC60034-1, U11004				

Accessories

Speed-Torque Curves (ASMT □ M Series)

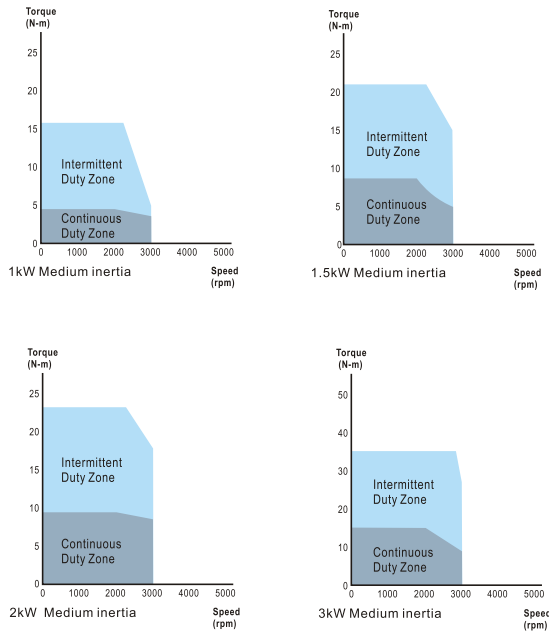

Delta Servo Accessories

Power Connector (for 100W~750W)

ASD-CAPW0000
AMP:350780-1



Item	Part No.	Qty	UNIT
Housing	AMP 350780-1	1	PCE
Terminal	AMP 350537-3	4	PCE

Power Connector (for 100W~750W with brake)

ASD-CAPW0100
AMP:350781-1



Item	Part No.	Qty	UNIT
Housing	AMP 350781-1	1	PCE
UVW Terminal	AMP 350537-3	4	PCE
Brake Terminal	AMP 350570-3	2	PCE

Delta Servo Accessories

Power Connector (for low inertia 1kW~3kW and medium inertia 1kW~1.5kW)

ASD-CAPW1000
CLAMP:MS3057-12A

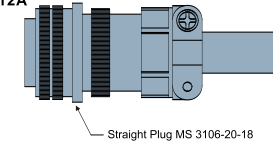

Power Connector (for medium inertia 2kW~3kW)

ASD-CAPW2000
CLAMP:MS3057-16A

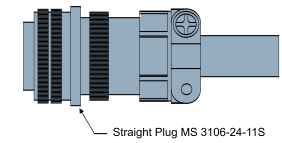

Power Cables (for 100W~750W)

ASD-CAPW0003, ASD-CAPW0005

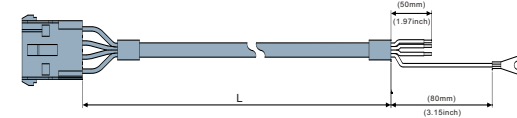

Item	Part No.	L	
		mm	inc
1	ASD-CAPW0003	3000 □ 10	118 □ 0.4
2	ASD-CAPW0005	5000 □ 10	197 □ 0.4

Power Cables (for 100W~750W with brake)

ASD-CAPW0103, ASD-CAPW0105

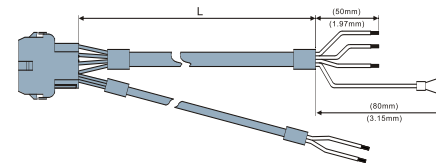

Item	Part No.	L	
		mm	inc
1	ASD-CAPW0103	3000 □ 10	118 □ 0.4
2	ASD-CAPW0105	5000 □ 10	197 □ 0.4

Power Cables (for 1kW~1.5kW)

ASD-CAPW1003, ASD-CAPW1005

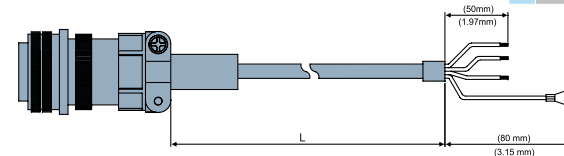

Item	Part No.	Straight plug	L	
			mm	inc
1	ASD-CAPW1003	MS 3106-20-18S	3000 □ 10	118 □ 0.4
2	ASD-CAPW1005	MS 3106-20-18S	5000 □ 10	197 □ 0.4

Accessories

Delta Servo Accessories

Power Cables (for 1kW~1.5kW with brake)

ASD-CAPW1103, ASD-CAPW1105

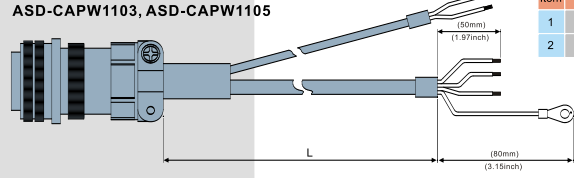

Item	Part No.	Straight plug	L	
			mm	inc
1	ASD-CAPW1103	MS 3106-20-18S	3000 □ 10	118 □ 0.4
2	ASD-CAPW1105	MS 3106-20-18S	5000 □ 10	197 □ 0.4

Power Cables (for low inertia 2kW~3kW)

ASD-CAPW1203, ASD-CAPW1205

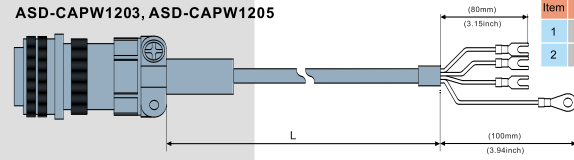

Item	Part No.	Straight plug	L	
			mm	inc
1	ASD-CAPW1203	MS 3106-20-18S	3000 □ 10	118 □ 0.4
2	ASD-CAPW1205	MS 3106-20-18S	5000 □ 10	197 □ 0.4

Power Cables (for low inertia 2kW~3kW with brake)

ASD-CAPW1303, ASD-CAPW1305

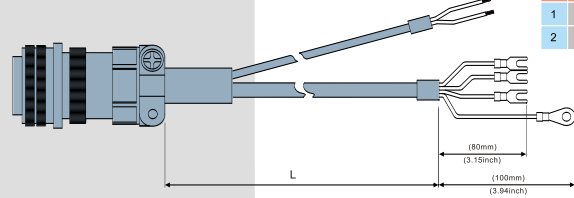

Item	Part No.	Straight plug	L	
			mm	inc
1	ASD-CAPW1303	MS 3106-20-18S	3000 □ 10	118 □ 0.4
2	ASD-CAPW1305	MS 3106-20-18S	5000 □ 10	197 □ 0.4

Power Cables (for medium inertia 2kW~3kW)

ASD-CAPW2203, ASD-CAPW2205

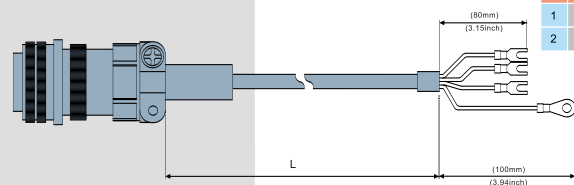

Item	Part No.	Straight plug	L	
			mm	inc
1	ASD-CAPW2203	MS 3106-24-11S	3000 □ 10	118 □ 0.4
2	ASD-CAPW2205	MS 3106-24-11S	5000 □ 10	197 □ 0.4

Power Cables (for medium inertia 2kW~3kW with brake)

ASD-CAPW2303, ASD-CAPW2305

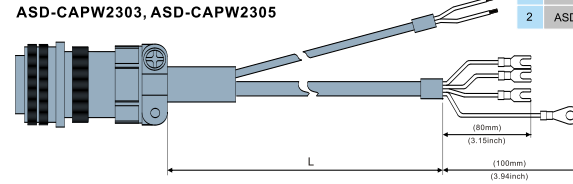

Item	Part No.	Straight plug	L	
			mm	inc
1	ASD-CAPW2303	MS 3106-24-11S	3000 □ 10	118 □ 0.4
2	ASD-CAPW2305	MS 3106-24-11S	5000 □ 10	197 □ 0.4

Encoder Connector (for 100W~750W)

ASD-CAEN000



Vendor Name	Vendor P/N
3M TAIWAN LTD	10120-3000VE
3M TAIWAN LTD	10320-52A0-008

Encoder Connector (for 1kW and above)

ASD-CAEN1000

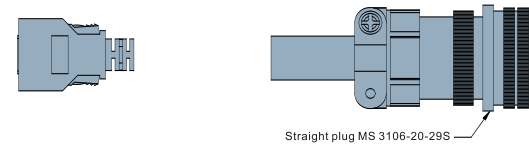

Encoder Cables (for 100W~750W)

ASD-CAEN0003, ASD-CAEN0005

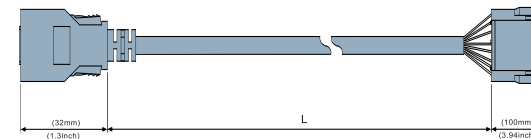

Item	Part No.	L	
		mm	inc
1	ASD-CAEN0003	3000 □ 10	118 □ 0.4
2	ASD-CAEN0005	5000 □ 10	197 □ 0.4

AC Servo System



Accessories

Delta Servo Accessories

Encoder Cables (for 1kW and above)

ASD-CAEN1003, ASD-CAEN1005

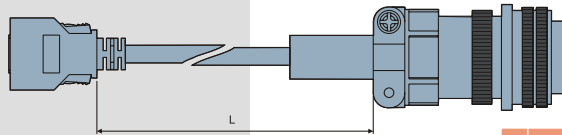

Item	Part No.	Straight plug	L	
			mm	inc
1	ASD-CAEN1003	MS 3106-20-29S	3000 □ 10	118 □ 0.4
2	ASD-CAEN1005	MS 3106-20-29S	5000 □ 10	197 □ 0.4

I/O Signal Connector

ASD-CNSC0050

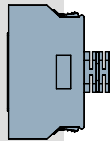

Vendor Name	Vendor P/N
3M TAIWAN LTD	1015-3000VE
3M TAIWAN LTD	10350-52A0-008

Terminal Block

ASD-BM-50A

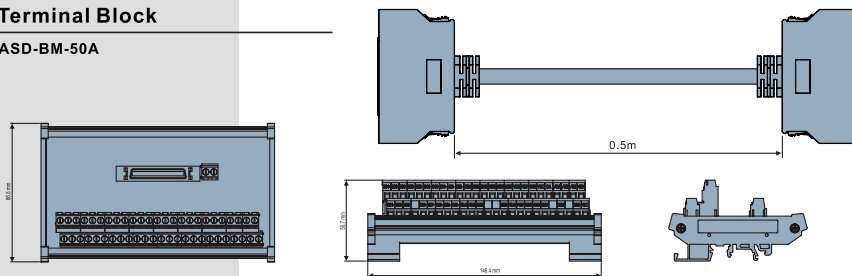

Communication Cable

ASD-CARS0003

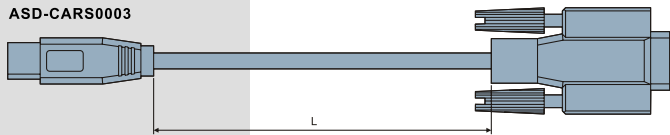

Item	Part No.	L	
		mm	inc
1	ASD-CARS0003	3000 □ 10	118 □ 0.4

Low Inertia Servo Motor Dimensions

100W to 750W Models(UNIT : mm)

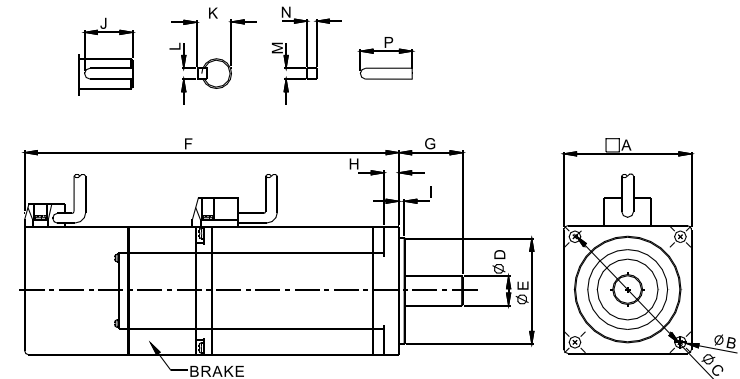

Model	ASMT01L250□□	ASMT02L250□□	ASMT04L250□□	ASMT07L250□□
Capacity(W)	100	200	400	750
A	40	60	60	80
B	4.5	5.5	5.5	6.6
C	46	70	70	90
D	8h6 +0.0 -0.009	14h6 +0.0 -0.011	14h6 +0.0 -0.011	19h6 +0.0 -0.013
E	30h7 +0.0 -0.021	50h7 +0.0 -0.025	50h7 +0.0 -0.025	70h7 +0.0 -0.030
F (without brake)	100.1	102.4	124.4	135
F (with brake)	135.7	137	159	171.6
G	25	30	30	35
H	5	6	6	8
I	2.5	3	3	3
J	16	20	20	25
K	9.2 +0.0 -0.2	16 +0.0 -0.2	16 +0.0 -0.2	21.5 +0.0 -0.2
L	3h9 -0.006 -0.031	5h9 -0.012 -0.042	5h9 -0.012 -0.042	6h9 -0.012 -0.042
M	3 +0.0 -0.025	5 +0.0 -0.030	5 +0.0 -0.030	6 +0.0 -0.030
N	3 +0.0 -0.025	5 +0.0 -0.030	5 +0.0 -0.030	6 +0.0 -0.030
P	16 +0.0 -0.18	20 +0.0 -0.21	20 +0.0 -0.21	25 +0.0 -0.21
Weight(without brake)	1.1(0.5)	1.98(0.9)	2.87(1.3)	5.5(2.5)
Weight(with brake)	1.54(0.7)	3.09(1.4)	3.97(1.8)	7.5(3.4)

Note: The boxes(□) at the ends of the model names are for version or options.
Dimensions are in millimeters. Weights are in pounds (lbs) and (kilograms (kg))

AC Servo System



Dimensions

Low Inertia Servo Motor Dimensions

1kW to 3kW Models(UNIT : mm)

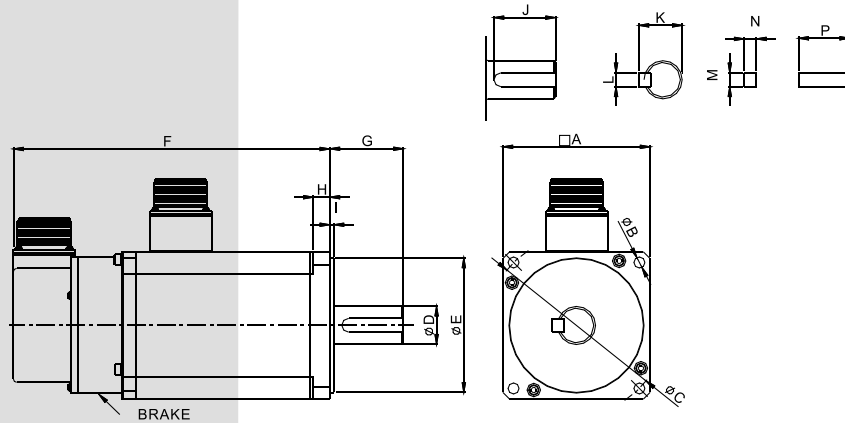

Model	ASMT10L250□□	ASMT20L250□□	ASMT30L250□□
Capacity(W)	1000	2000	3000
A	100	100	130
B	9	9	9
C	115 +0.2 -0.2	115 +0.2 -0.2	145 +0.2 -0.2
D	22h6 +0.0 -0.013	22h6 +0.0 -0.013	24h6 +0.0 -0.013
E	95h7 +0.0 -0.035	95h7 +0.0 -0.035	110h7 +0 -0.035
F (without brake)	158	194	173
F (with brake)	190	226	211
G	45	55	55
H	17	17	15
I	7	7	4
J	34	44	44
K	25 +0.0 -0.2	25 +0.0 -0.2	27 +0.0 -0.2
L	8h9 +0.0 -0.036	8h9 +0.0 -0.036	8h9 -0.0 -0.051
M	8	8	8
N	7	7	7
P	30	40	40
Weight(without brake)	10.36(4.7)	12.57(6.7)	17.64(8.0)
Weight(with brake)	13.89(6.3)	16.09(8.3)	23.59(10.7)

Medium Inertia Servo Motor Dimensions

1kW to 3kW Models(UNIT : mm)

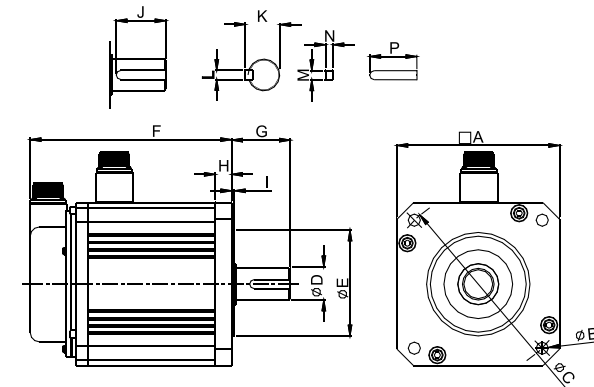

Model	ASMT10M250□□	ASMT15M250□□	ASMT20M250□□	ASMT30M250□□
Capacity(W)	1000	1500	2000	3000
A	130	130	180	180
B	9	9	13.5	13.5
C	145 +0.2 -0.2	145 +0.2 -0.2	200 +0.2 -0.2	200 +0.2 -0.2
D	22h6 +0.0 -0.013	22h6 +0.0 -0.013	35h6 +0.0 -0.016	35h6 +0.0 -0.016
E	110h7 +0.0 -0.035	110h7 +0.0 -0.035	114.3h7 +0 -0.035	114.3h7 +0 -0.035
F (without brake)	143	158	164	212
F (with brake)	181	196	213	258
G	55	55	75	75
H	15	15	20	20
I	4	4	4	4
J	44	44	65	65
K	25 +0.0 -0.1	25 +0.0 -0.1	38 +0.0 -0.2	38 +0.0 -0.2
L	8h9 +0.0 -0.036	8h9 +0.0 -0.036	10h9 -0.0 -0.036	10h9 -0.0 -0.036
M	8	8	10	10
N	7	7	8	8
P	40	40	60	60
Weight(without brake)	10.58(4.8)	15.43(7.0)	26.46(12.0)	37.48(17.0)
Weight(with brake)	16.53(7.5)	21.38(9.7)	41.89(19.0)	52.9(24.0)

NOTE: The boxes(□) at the ends of the model names are for version or options.
Dimensions are in millimeters. Weights are in pounds (lbs) and (kilograms (kg))

NOTE: The boxes(□) at the ends of the model names are for version or options.
Dimensions are in millimeters. Weights are in pounds (lbs) and (kilograms (kg))

AC Servo System

ASDA-A

Dimensions

Dimensions of Servo Drive (Units: mm)

ASD-A0121LA ; ASD-A0221LA ; ASD-A0421LA(100W~400W)

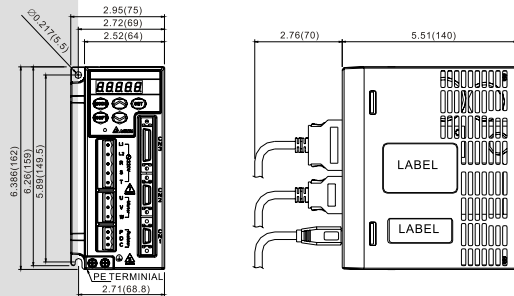

SCREW : M4x 0.7
MOUNTING SCREW TORQUE :14 (kgf-cm)

WEIGHT (KG)

3.3(1.5)

Note : 1. Dimensions are in inches (millimeters).
2. Weights are in pounds (lbs) and (kilograms (kg))

ASD-A2023 □ A ; ASD-A3023 □ A (2kW~3kW)

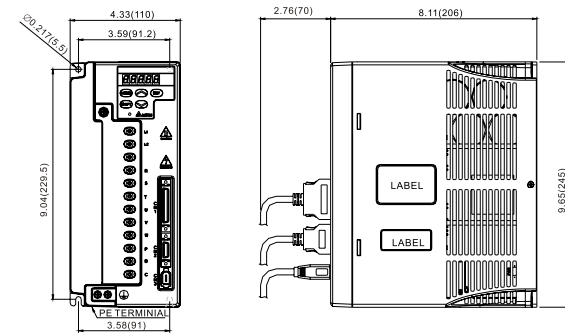

SCREW : M4x 0.7
MOUNTING SCREW TORQUE :14 (kgf-cm)

WEIGHT (KG)

6.6(3.0)

Note : 1. Dimensions are in inches (millimeters).
2. Weights are in pounds (lbs) and (kilograms (kg))

ASD-A0721LA ; ASD-A1021 □ A ; ASD-A01521 □ A(750W~1.5kW)

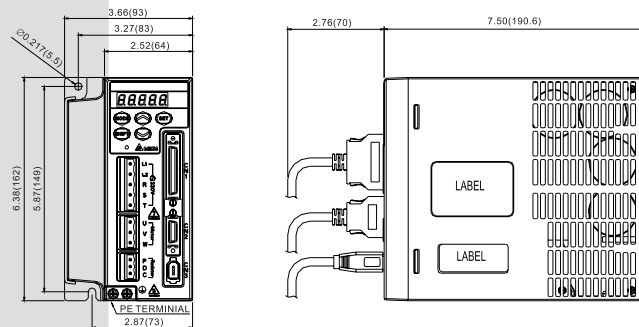

SCREW : M4x 0.7
MOUNTING SCREW TORQUE :14 (kgf-cm)

WEIGHT (KG)

4.4(2.0)

Note : 1. Dimensions are in inches (millimeters).
2. Weights are in pounds (lbs) and (kilograms (kg))

