



JVL...integration in motion

## QuickStep, integrated stepper motor MIS34 up to 9 Nm



The Quickstep series of stepper motors with integrated electronics represents a major step forward. The stepper motor, encoder, driver, controller, indexer are built-into the motor so they form a closed unit with high IP protection. The integrated motor provides easy setup, programming, installation and use.

The advantages of this solution are:

- Compact. Does not take up space in cabinet.
- De-central intelligence. PLC built-in.
- Simple installation. No cable between motor and driver.
- EMC safe. Switching noise remains in the motor.
- Low cost compared to step or servomotor with separate driver.

The new integrated stepper motor offer RS485 and CANopen serial interface and programmable motion controller. Wireless or Industrial Ethernet are optional. All the necessary electronics in a stepper system are integrated in the motor itself. The newest technology have been used to obtain an incredibly high step resolution of 409600 step/revolution resulting in unsurpassed smoothness and silent running. MIS340 with 3Nm is only 95 mm (3,74") long and MIS342

with 9Nm only 155mm (6,14") and it is therefore the shortest motor in the world with built-in controller.

The motor contains everything needed to solve a modern control task as stand-alone or controlled from a PLC or PC. 8 I/O points can be individually configured to digital input, digital output or analogue input. Modbus RTU or RS485 interface provide easy connections to a PLC or HMI. An ActiveX/OCX driver is available to make interfacing to LabView, Excel, VB or other Windows-programs simple. The MAC motor standard protocol enables MAC motors and QuickStep motors and SMC85 controllers to be connected on the same RS485 bus with up to 254 axes.

- Shortest length in the industry only 95 mm for 3 Nm
- Resolution up to 409600 step/rev equal to 2048 microsteps per fullstep.
- Velocity precision 0.01 RPM. Acceleration precision 1 RPM/sec.
- Built-in PLC with 8 I/O: each DI or DO 24V or 0-5V (12bit) analogue input with advanced input filtering.
- RS485 up to 921 kbit and Modbus RTU.
- RS422 and RS485 for encoder I/O and connection to external HMI or PLC

- Point-to-point or multiaxis operation up to 254 axes on the same RS485 bus
- CANbus with CANopen DSP402 and DS301 are under development
- Pulse/Direction mode for electronic gearing
- High speed position capture
- Wide Supply range from 12-80 VDC delivering high torque at high speed
- Motor current 0-9 Amp RMS, 12.6 Amp Peak
- Dual supply maintain position values etc in emergency-stop situations
- ActiveX / OCX driver available as well as MacTalk and MODBUS protocol
- Powerful graphic programming with +/- calculations and advanced functions
- All connections with M12 connectors
- Option for double shaft and encoder single or multi turn without external battery
- Optional Industrial Ethernet Profinet, EthernetIP, Ethercat, MODBUS TCP and Powerlink.

The PCB with stepper motor controller as used inside the motor is also available as type no. SMC85.

Flange size is 86x86 mm which corresponds to the NEMA34 standard and shaft diameter can be either 9.53 mm or 14 mm with key depending on type. MIS340 is also available with hollow shaft  $\varnothing$ 12 mm.

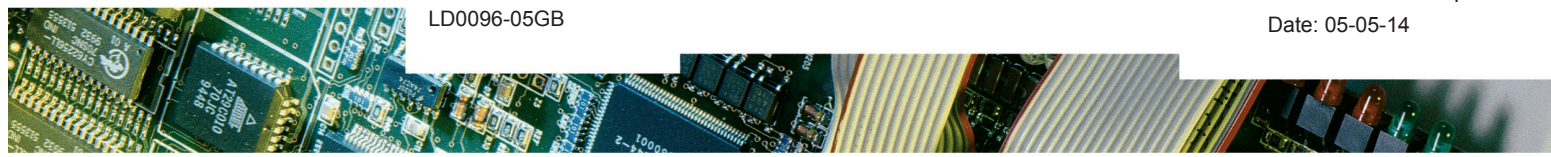

## Interface possibilities

### Industrial Ethernet:

Industrial Ethernet are the new way to control motors and more and more PLC manufactures have it built-in. The benefit for Industrial Ethernet are the worldwide acceptance from many companies like Beckhoff (Ether-CAT), Siemens (Profinet), Rockwell (EtherNet/IP), B&R (Powerlink) but also Modbus TCP and Sercos III are known. It offer very high response time and 100Mbit communications speed.

### Wireless :

Bluetooth, WLAN, IEEE802.15.4 and Zigbee wireless module. For many applications, wireless communications is superior to cabled solutions. Eg for handheld remote control, battery operated trucks or flying machine to replace slip rings. No more broken cables or loose connections. Cost savings during installation and maintenance. Easier to move around and change equipment. Distributed intelligence when it is best. Control your motor from a mobile device like iPad

### CAN Open:

CANopen can be used in together with RS485 communication and PLC function. CAN Open slave module with baudrate up to 1Mbit. CANopen DS301 V3.0 and DSP 402 V2.0. All registers of the in the motor can be read and written Notice that CANopen only are available on the Q9 version. Devicenet and Profibus are under development.

### SSI encoder / RS422 :

An external encoder with SSI interface can be connected to a special dedicated SSI connector. Via the built-in PLC can 2 outputs in the connector be activated to make a Zero setting of the encoder and change counting direction. Power 24VDC for the encoder are also available so the encoder can be connected directly to 1pcs M12 connector without any need for external wire or power supply. The SSI connector contain 2 RS422 ports that can be used for other purposes like pulse direction or highspeed serial interface to external equipment. Please contact JVL for further details.

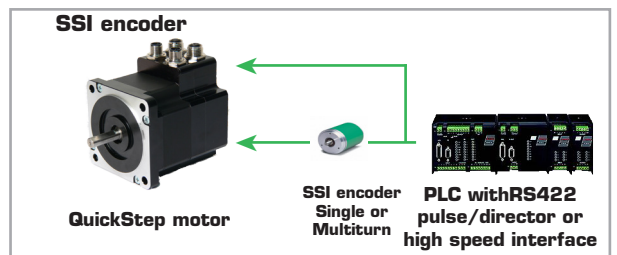
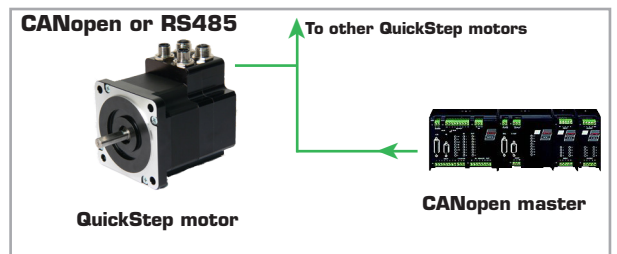
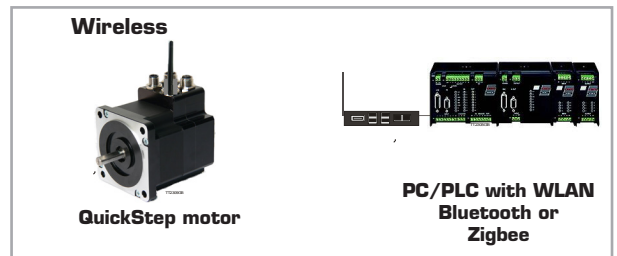
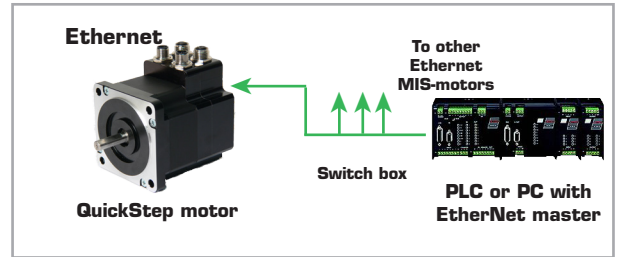

## System and Feature Overview

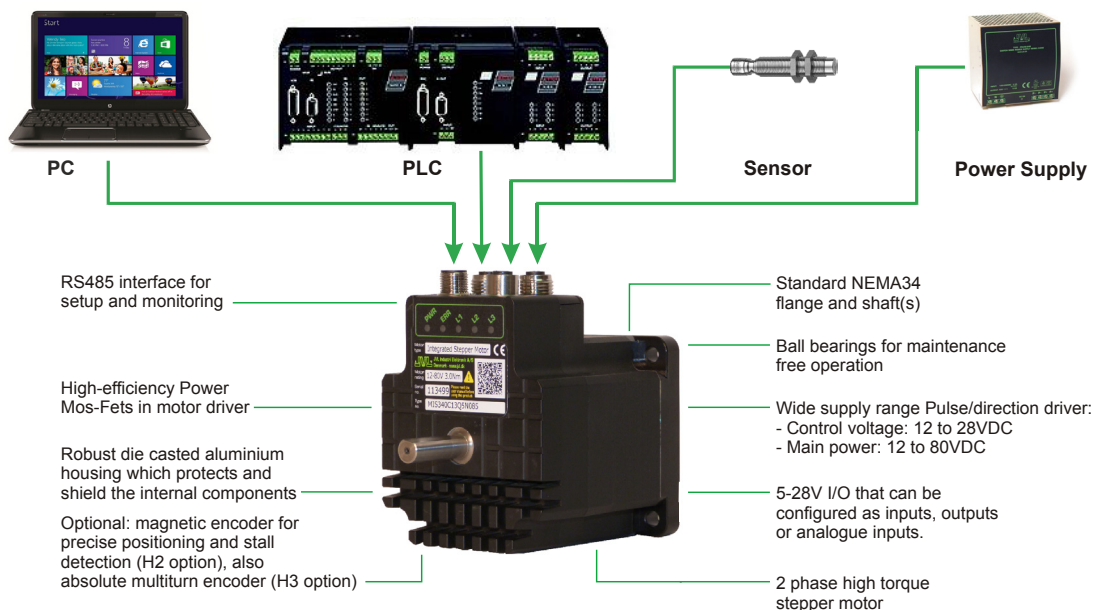

## Interface and operation mode

### Positioning and Velocity Mode

In this mode the QuickStep motor positions the motor via commands sent over the serial interface. Various operating parameters can be changed continuously while the motor is running. This mode of operation is used primarily in systems where the Controller is permanently connected to a PC/PLC via the interface through MACTalk or MODBUS protokol. This mode is also well suited for setting up and testing systems. The mode is also used when programming is made.

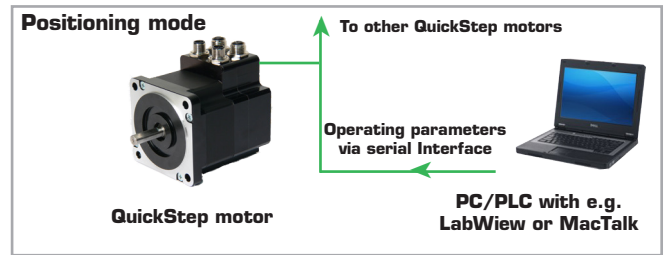

### Gear Mode

In this mode the QuickStep motor functions as in a step motor driver. The motor moves one step each time a voltage pulse is applied to the step-pulse input. Velocity, acceleration and deceleration are determined by the external frequency, but can be limited and controlled by the QuickStep motor. In addition, the QuickStep motor also provides a facility for electronic gearing at a keyed-in ratio. PLC program and other functions can run simultaneously monitoring.

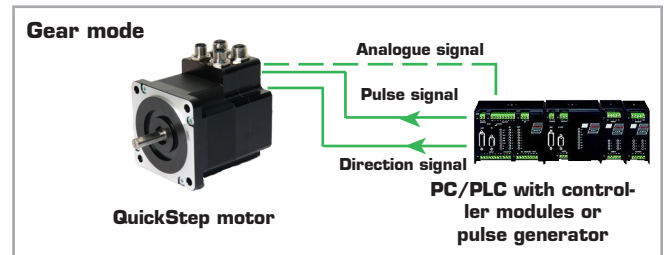

### PLC mode

Motor have built-in PLC with 8 IOA that individual can be configured to 24VDC digital input, output or analogue input. Eg can IO be configured as 5 inputs, 2 outputs and 1 analogue input. PLC program is made on the PC with MACTALK software and downloaded to the motor and stored in flash memory. Additional are there a RS422 channel that can be used for external encoder in or output, pulse/directions signal or for other serial data purposes like SSI. Programming are made with JVL icon command toolbox where all kind of program can be made fast and efficient. You don't need to be PLC or high level programmer. Programming are done by selecting icons and in a intuitive manner so programming only take a few hours.

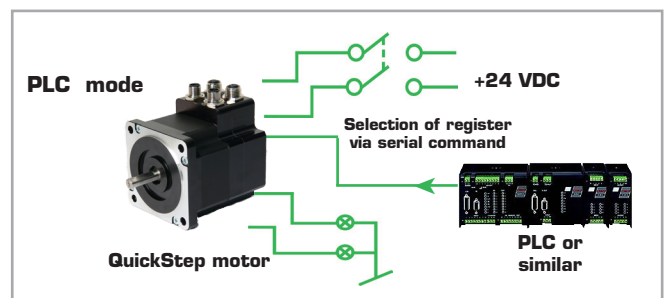

## Positioning/Speed Control version

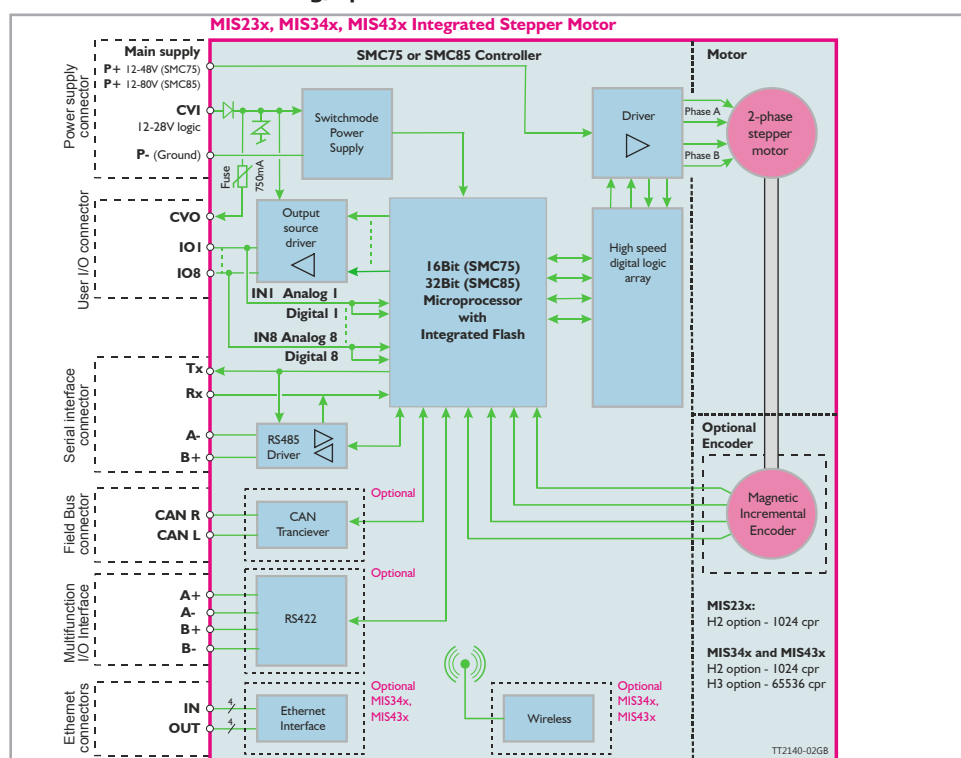

# Setup and programming with software MacTalk

**Setup save/open**  
The complete setup can be either saved or reloaded from a file using these buttons

**Startup mode**  
The basic functionality of the unit is setup in this field.

**Profile Data**  
All the main parameters for controlling the motor behaviour are setup in this field.

**Driver Parameters**  
These fields are used to define standby and running current.

**Gear Factor**  
The gear ratio can be entered here

**Motion Parameters**  
The distance the motor has to run is entered here

**System control**  
Use these buttons to save data permanently, reset the motor etc.

**Error Handling**  
Use these fields to define error limits for the position range etc.

**Motor status**  
This field shows the actual motor load, position and speed etc.

**Run status**  
Shows what the status of the motor is. The Bus voltage for the motor and the temperature of the driver is also shown

**Inputs**  
The status of the digital inputs are shown here and the analogue value

**Outputs**  
The status of the outputs are shown here and can be activated by the cursor

**Errors**  
If a fatal error occurs, information will be displayed here.

**Warnings**  
Here different warnings are shown

**Help Line**  
*Left area:* If parameters entered are outside their normal values, errors are shown here.  
*Right area:* Here it is possible to see if a motor is connected, the type, version and serial no.

**Zero Search**  
All the parameters regarding the position zero search can be specified here.

**Autocorrection**  
The parameters used to get the correct position, if it is a motor with encoder

**Communication**  
The actual address of the motor can be entered here  
TT2145GB

## MacTalk introduction

The MacTalk software is the main interface for setting up the QuickStep motor for a specific application. The program offers the following features:

- Choice of the operating mode of the QuickStep motor.
- Changing main parameters such as speed, motor current, zero search

type, etc.

- Monitoring the actual motor parameters in real time, such as supply voltage, input status, etc.
- Changing protection limits such as position limits.
- Saving all current parameters to disc.
- Restoring all parameters from disc.
- Saving all parameters permanently

in the motor.

- Updating the motor firmware or MacTalk software from the internet or a file.

The main window of the program changes according to the selected mode, thus only showing the relevant parameters for operation in the selected mode.

## Command toolbox description

The toolbox used for the programming covers 18 different command types. The idea for the commands - is to have an easy access to the most common functions in the motor. The button "Set register in the QuickStep motor" or "Wait for a register value before continuing" gives direct access to +50 registers down in the basic Quick-Step motor such as the gear ratio or the actual torque register. A calculator with +, -, \*, / can manipulate with all registers.

In total this gives a very power full programming tool since >95% of a typical program can be build using the simple command icons and the last part is obtained by accessing the basic motor registers directly.

Below is a short description of all 18 command icons.

Use: Initiates any motor movement relative or absolute.

Use: Inserts a remark/ Comment in the program source code.

Use: Set the motor in the desired mode such as position- or velocity mode.

Use: Set a certain state at one or multiple digital outputs.

Use: Unconditional jump from one program line to another.

Use: Conditional jump from one program line to another. Input dependent

Use: Inserts a delay in the program specified in milliseconds.

Use: Wait for a certain state at one or multiple digital inputs.

Use: Write a value to almost any register in the basic MAC/MIS motor.

Use: Conditional jump from one program line to another. Register dependent

Use: Wait for a certain state at one or more of the digital inputs.

Use: Save the actual motor position to an intermediate register.

Use: Initiates a zero search to a sensor or a torque (no sensor).

Use: Preset the position counter to a certain value.

Use: Change mode and activate register using a single command.

Use: Performs a calculation using register values and constants.

Use: Compares two registers to each other before jumping or moving in the program.

Use: Binary format instead of graphic commands.

TT1103GB

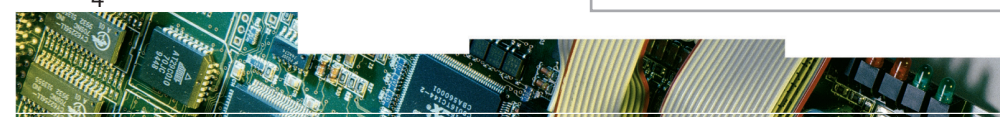

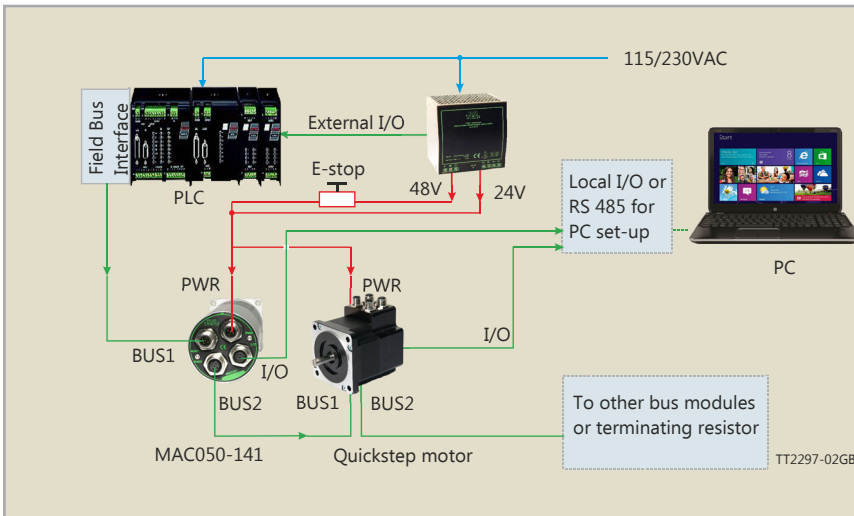

Quickstep and MAC motor in an RS485 or CANbus network

## Torque versus speed

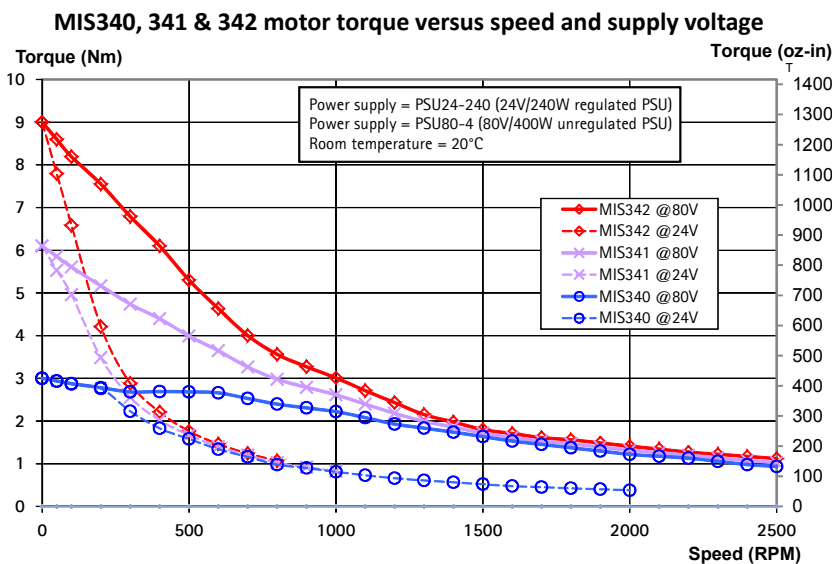

TI2223-02GB

## Motor Specifications

Motor Type	MIS340 *	MIS341	MIS342	Unit
Holding Torque	3.0 [424]	6.1 [863]	9.0 [1274]	Nm [Oz/In]
Running Torque	2.5 [354]	5.1 [722]	7.2 [1019]	Nm [Oz/In]
Power	260	288	315	W
Inertia	1.4 [0.0198]	2.7 [0.0382]	4.0 [0.0566]	kgcm <sup>2</sup> [Oz-In-in <sup>2</sup> ]
Length (L)	95.0 [3.74]	125.0 [4.92]	155.0 [6.10]	mm [inch]
Shaft dia. (D)	9.53* [0,37]	9.53 [0,37]	14.0 [0,55]	mm [inch]
d	9.0 [0.35]	9.0 [0.35]		mm [inch]
Weight	2.0 [4.41]	3.1 [6.83]	4.3 [9.5]	Kg [lb]

\* MIS340 also available with hollow shaft ø12 mm. All motor are available with double shaft

## Accessories

RS485-M12-1-5 cable for M12, 5pin to RS485 USB. 5m	
RS485-USB-ATC-820 USB to RS485 adaptor. 0.5m	
WI1000-M12xxVxxN M12, angled female/male cable	
WI1000-M12xxTxxN M12, straight female/male cable	
MAB34x, Front mounted brake 1.7 Nm. M8 connector	
PSU24-075 PSU 24VDC/3.2A, 75W. 85-264VAC DIN Switch-mode. UL/CE approved. DIN rail.	
PSU48-240. PSU48VDC/5A. 240W. 100-240 VAC Switch-mode power supply. UL/CE approved. DIN rail.	
PSU80-4 Unregulated power supply 400 WRMS 1200W peak. 19" or base plate mounting. 70-80 VDC	
MacTalk MAC motor Windows software for setup and programming	
PA0190 Junction box that split 17 pin M12 to 4 pcs M12	

## Electrical data

	Min.	Max.	Absolute Max.	Unit
P+	12	80	-	VDC
CVI	12	28	32	VDC
CVI no output activated		95@24VDC		mA
Motor Current	0	9	12,7	A
Input Logic Low	-0.5	0.9		VDC
Input Logic High	1.9	28	32	VDC
Output Logic High	12	28	32	VDC
Analogue Input	0	5	32	VDC
Output Current			350*	mA

\*8 Outputs: Totally max. 800 mA. for all 8 outputs active

## Versions with positioning and speed control:

QUICKSTEP M12 connector overview	Power Male 5 pin	I01-8 RS485 MFIO Female 17 pin	RS485 Female 5 pin	RS485 + IO4 Female 8 pin	CANopen Female 2 x 5 pin	SSI encoder Male 8 pin	Profibus Male 2 x 5 pin B-coded	Ethernet Female 2 x 4 pin D-codes
MIS34xCyyQ5zz85 (Pre. type)	X	X	X	X				
MIS34xCyyP6zz85 (CAN-open)	X	X			X			
MIS34xCyyQ9zz85 (SSI input)	X	X		X		X		
MIS34xCyyExzz85 (Ethernet)	X	X						X
MIS34xCyyFBzz85 (Bluetooth)	X	X						
MIS34xCyyFPzz85 (Profibus)	X	X					X	
M12 Pin 1	P+ (12-80VDC)	I01	BO+ (RS485)	I01	CAN_SHLD	IO5 Zero Set	5VDC	TXO_P
M12 Pin 2	P+ (12-80VDC)	GND	A0- (RS485)	I02	Unused	IO6 CNTDIR	A-	RXO_P
M12 Pin 3	P- (GND)	I02	BO+ (RS485)	I03	CAN_GND	A+ (Clock+)	DGND	TXO_N
M12 Pin 4	CVI (12-28VDC)	I03	A0- (RS485)	GND	CAN_H	GND	B+	RXO_N
M12 Pin 5	P- (GND)	B1- (RS422)	GND	BO- (RS485)	CAN_L	B- (Data in-)	SHIELD	-
M12 Pin 6	-	I04	-	A0+ (RS485)	-	B+ (Data in+)	-	-
M12 Pin 7	-	A1- (RS422)	-	I04	-	A- (Clock-)	-	-
M12 Pin 8	-	B1+ (RS422)	-	CVO (out)	-	CVO (out)	-	-
M12 Pin 9	-	CVO (out)	-	-	-	-	-	-
M12 Pin 10	-	A1+ (RS422)	-	-	-	-	-	-
M12 Pin 11	-	I05	-	-	-	-	-	-
M12 Pin 12	-	I06	-	-	-	-	-	-
M12 Pin 13	-	I07	-	-	-	-	-	-
M12 Pin 14	-	I08	-	-	-	-	-	-
M12 Pin 15	-	A0+ (RS485)	-	-	-	-	-	-
M12 Pin 16	-	GND	-	-	-	-	-	-
M12 Pin 17	-	BO- (RS485)	-	-	-	-	-	-
M12 connector solder terminals	WI1008-M12F5SS1	(not available)	WI1008-M12M5SS1	WI1008-M12M8SS1	WI1008-M12M5SS1	WI1008-M12F 8SSI	WI1028-M12F5SS1	(not available)
M12 cables 5m.	WI1000-M12F5T05N	WI1009-M12M17T05N	WI1005-M12M8VM5V03N	WI1000-M12M8T05N	WI1006-M12F5TM5T05N	WI1000-M12F8T05N	WI1026-M12F5S05R	WI1046-M12M4S05R

x=0~3Nm, x=1~6Nm, x=2~9Nm. yy=12~9.53 mm shaft, yy=14~14.0 mm shaft zz:=NO° No encoder, H2~magnetic encoder, H3~absolut encoder

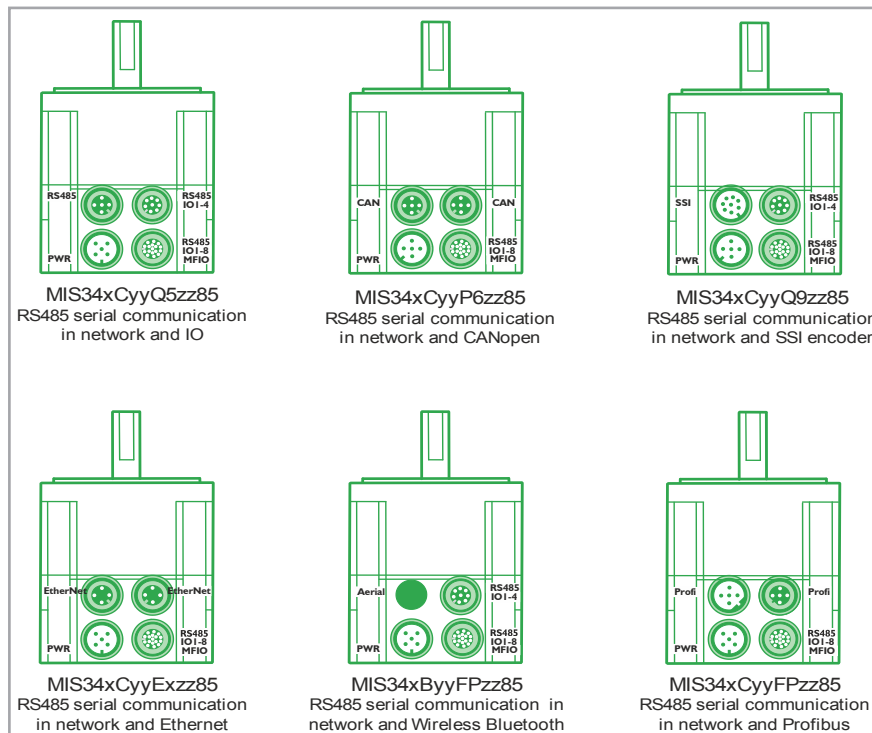

PWR: 5 pin male RS485: 8 pin female CAN: 5 pin male I/O1-8: 17 pin female EtherNet: 4pin female Profibus: 5 pin male and female B-coded

5-pole cable connector	
Pin no.	Color
1	Brown
2	White
3	Blue
4	Black
5	Grey

8-pole cable connector	
Pin no.	Color
1	White
2	Brown
3	Green
4	Yellow
5	Grey
6	Pink
7	Blue
8	Red

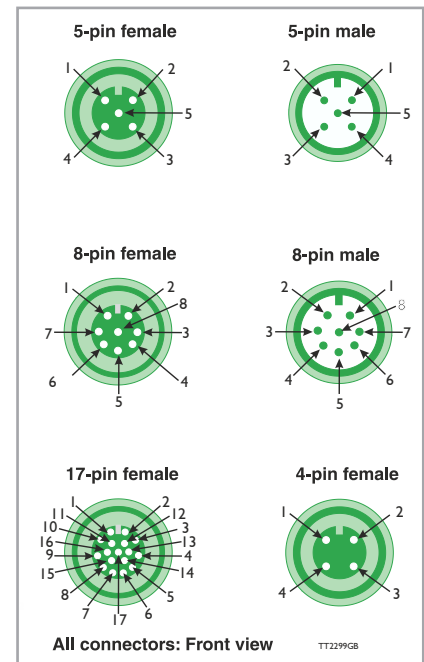

17-pole cable connector	
Pin no.	Color
1	Brown
2	Blue
3	White
4	Green
5	Pink
6	Yellow
7	Black
8	Grey
9	Red
10	Violet
11	Grey/pink
12	Red/blue
13	White/Green
14	Brown/Green
15	White/Yellow
16	Yellow/Brown
17	White/Grey



# Ordering Information

Motor type	Size	Generation	IP and shaft	Connection	Feedback	Driver Technology
MIS	340	C	12	Q5	NO	85
<p>73 SMD73 driver 15-28VDC. Pulse and direction driver. (only orders more than 10pcs. See note1)                      74 SMD74 Driver 12-48VDC based on SMC73 technology, but up to 48 VDC supply voltage                      75 SMC75 controller with MAC protokol. 12-48VDC and optional encoder#                      85 SMC85 controller with 12-80VDC and new high resolution driver</p> <p>N0 No feedback                      H2 Magnetic encoder feedback. 256x4 pulses/rec. Only SMC75, SMC85, MIS23x and MIS34x                      H3 Absolut multiturn encoder magnetic feedback. Only SMC85 and MIS34x</p> <p>M1 M12 1pcs. 5pin male . SMD73 pulse/direction driver.                      M2 M12 2 pcs. 5 pin male (power), 8 pin female (RS485, 4IOA). SMC75                      M3 M12 3 pcs. 5 pin male (power), 8 pin female (RS485, IOA 1-4), 5 pin female (RS485). SMC75                      M4 M12 3 pcs. 5 pin male (power), 8 pin female (RS485, IOA 1-4), 8 pin female (5V serial, IOA5-8). SMC75                      M5 M12 4 pcs. 5 pin male (power), 8 pin female (RS485, IOA 1-4), 5 pin female (RS485), 8 pin female (5V serial, IOA 5-8). SMC75                      M6 M12 4 pcs. CANopen:5 pin male (power), 8 pin female (RS485, IOA 1-4), 8 pin female (5V serial, IOA 5-8), 5 pin male (CAN) SMC75                      M7 M12 4 pcs. DeviceNet:5 pin male (power), 8 pin female (RS485, IOA 1-4), 8 pin female (5V serial, IOA 5-8), 5 pin male (DeviceNet) . SMC75                      M8 M12 4 pcs. SSI+CANopen:5 pin male (power), 8 pin female (RS485, IOA 1-4), 8 pin male (IOA 5-6), 5 pin male (CANopen). SMC75                      M9 M12 4 pcs. SSI:5 pin male (power), 8 pin female (RS485, IOA 1-4), 8 pin male SSI (IOA 5-6), 5 pin female RS485. SMC75                      MA M12 3 pcs. 5 pin male (power), 8 pin female (RS485, IOA 1-4), 5 pin male (CAN). SMC75                      MB M12 4 pcs. 5 pin male (power), 8 pin female (RS485, IOA 1-4), 5 pin male (CAN), 5 pin female (CAN). SMC75                      MC M12 3 pcs. 3m power cable PG12, 8 pin female (RS485, IOA 1-4), 5 pin male (CAN) 5 pin female (CAN). SMC75                      MD M12 3 pcs. 3m power cable PG12, 8 pin female (RS485, IOA 1-4), 5 pin male (CAN) 5 pin female (CAN). SMC75                      R1 Radial connection. M12 2 pcs. 5 pin male (power), 8 pin female (RS485, 4IOA) on 2 sides. High volumen SMC75                      R2 Radial connection. M12 2 pcs. 5 pin male (power), 8 pin female (RS485, 4IOA) on 2 sides. 1-50 pcs SMC75                      C1 2 pcs PG12 cable Clands M12x1.5 and no cable mounted (side mounted only MIS231)                      C2 2 pcs PG12 cable Clands M12x1.5 and 5m power and IO cable with shield mounted (side mounted)                      C3 2 pcs PG12 cable Clands M12x1.5 and 1m power and IO cable with shield mounted (side mounted)                      C6 CANOPEN + 2 pcs PG12 cable clands M12x1,5 and 2m power and IO cable with shield mounted (Side Mounted)                      W0 2 pcs PG12 cable Clands M12x1,5 and no cable mounted (rear end mounted)                      W1 2 pcs PG12 cable clands M12x1,5 and 1 m power and 1m IO cable with shield mounted (Rear end mounted)                      W2 2 pcs PG12 cable clands M12x1,5 and 5m power and 1m IO cable with shield mounted (Rear end mounted)                      FP MIS34x 4 pcs M12. 5 pin male (power), 8 pin female (RS485), 12 female (IO), 5 pin male (B) Profibus DP                      Q6 MIS34x 4 pcs M12. 5 pin male (power), 8 pin female (RS485), 12 female (IO), 5 pin male (A)(CANopen)                      Q9 MIS34x 4 pcs M12. 5 pin male (power), 8 pin female (RS485), 17 female (IO), 8 pin male (SSI + IO5-6)                      Q5 MIS34x 4 pcs M12. 5 pin male (power), 8 pin female (RS485), 17 female (IO), 5 pin male (RS485)                      P6 MIS34x 4 pcs M12. 5 pin male (power), 8 pin female (RS485), 17 female (IO), 5 pin male (A)(CANopen)                      EC MIS34x 4 pcs M12. 5 pin male (power), 17 pin female (IO), 2x4 pin male (D) Ethernet Ethercat                      EL MIS34x 4 pcs M12. 5 pin male (power), 17 pin female (IO), 2x4 pin male (D) Ethernet Powerlink                      EI MIS34x 4 pcs M12. 5 pin male (power), 17 pin female (IO), 2x4 pin male (D) Ethernet Ethernet IP                      EM MIS34x 4 pcs M12. 5 pin male (power), 17 pin female (IO), 2x4 pin male (D) Ethernet MODBUS TCP                      EP MIS34x 4 pcs M12. 5 pin male (power), 17 pin female (IO), 2x4 pin male (D) Ethernet Profinet                      EX MIS34x 4 pcs M12. 5 pin male (power), 17 pin female (IO), 2x4 pin male (D) Ethernet Ethernet IP                      FB MIS34x 4 pcs M12. 5 pin male (power), 8 pin female (RS485), 12 pin female (IO), Antenna Wireless Bluetooth                      EW MIS34x 4 pcs M12. 5 pin male (power), 8 pin female (RS485), 12 pin female (IO), Antenna Wireless LAN</p> <p>1 6.35mm shaft and IP42. Round shaft.                      2 6.35mm shaft and IP65 (motor shaft and body) IP66 (Rear end and connector) and special painting                      3 10,0 mm shaft and IP42                      4 10.0mm shaft and IP65 (motor shaft and body) IP66 (Rear end and connector) and special painting                      5 14mm shaft and IP42                      6 14mm shaft and IP65 (motor shaft and body) IP66 (Rear end and connector) and special painting                      7 8mm shaft 52mm long for HFOS worm gear. IP42                      8 6.35mm shaft with D-cut and IP42                      9 5.00 mm shaft with D-cut and IP42                      10 7.00mm shaft 45.5 mm long for Dunker flange and IP42                      11 6.35mm shaft . Black painted and rubber sealing in rear end IP65. Shaft end IP42.                      12 9,53mm shaft D shape . Black painted. Shaft end IP42. Only MIS34x                      13 9,53mm shaft D shape . Black painted. Shaft end IP42. Rear end shaft ø10mm 30mm long D shape. Only MIS34x                      14 14mm with 5x5 key shaft. Black painted. Shaft end IP42. Only MIS34x                      15 14mm with 5x5 key shaft. Black painted. Shaft end IP42. Rear end shaft ø10mm 30mm long D shape. Only MIS34x                      16 5.00 mm round shaft IP42                      17 9,53mm shaft D shape . Black painted. Shaft and rear end IP65. Only MIS34x                      18 9,53mm shaft D shape . Black painted. Shaft and rear end IP65. Rear end shaft ø10mm 30mm long D shape. Only MIS34x                      19 14mm with 5x5 key shaft. Black painted. Shaft and rear end IP65. Only MIS34x                      20 14mm with 5x5 key shaft. Black painted. Shaft and rear end IP65. Rear end shaft ø10mm 30mm long D shape. Only MIS34x                      21 16mm with key 5x9mm (only for ???)                      22 19mm with key 6x20mm (only for MIS43x/ MST42x )                      23 8mm Shaft IP67 , motor and housing and rear end IP67 (only MIS234)                      24 14 mm Shaft with D shape , Shaft IP67 motor and housing and rear end IP65 (only NEAM34 IP65 motors )                      25 6,35mm Shaft IP65 , motor and housing and rear end IP65                      27 Potted. High G. 9,53mm shaft D shape . Black painted. Shaft end IP42. Only MIS34x                      28 Potted. High G. 14mm with 5x5 key shaft. Black painted. Shaft end IP65. Only MIS34x                      Ex Linear stepmotor External nut. x can be A to Z. Ptich from 0,6 to 25,4mm/rev. See jvl.dk                      Nx Linear stepmotor Non-Captive. External nut.(Not MIL). x can be A to Z. Ptich from 0,6 to 25,4mm/rev. See jvl.dk                      Cx Linear stepmotor captive with intern guider. x can be A to Z. Ptich from 0,6 to 25,4mm/rev. See jvl.dk                      Bx Linear stepmotor External nut with ball screw. x can be A to Z. Ptich from 0,6 to 25,4mm/rev. See jvl.dk</p> <p>A Driver 3,0A/phase, Motor 3 Amp and 200step/rev                      B Driver 6,0A/phase, Motor 6 Amp and 200step/rev                      C Driver 9,0A/phase, Motor 9 Amp and 200step/rev                      D Driver 12,0A/phase, Motor12 Amp and 200step/rev                      F Driver 3,0A/phase, Motor 3 Amp and 400step/rev                      G Driver 6,0A/phase, Motor 6 Amp and 400step/rev                      H Driver 9,0A/phase, Motor 9 Amp and 400step/rev                      I Driver 12,0A/phase, Motor 12 Amp and 400step/rev                      K Driver 4,6A/phase, Motor 6 Amp and 200step/rev (only MIS23x)                      L Driver 4,6A/phase, Motor 6 Amp and 200step/rev (only MIS23x)</p> <p>230 NEMA23 step motor                      231 NEMA23 step motor                      232 NEMA23 step motor                      234 NEMA23 step motor                      340 NEMA34 step motor (Future option)                      341 NEMA34 step motor (Future option)                      342 NEMA34 step motor (Future option)</p>						
<p>MIS MISxxx Motor Integrated Stepper motor.</p>						

# Mechanical dimensions

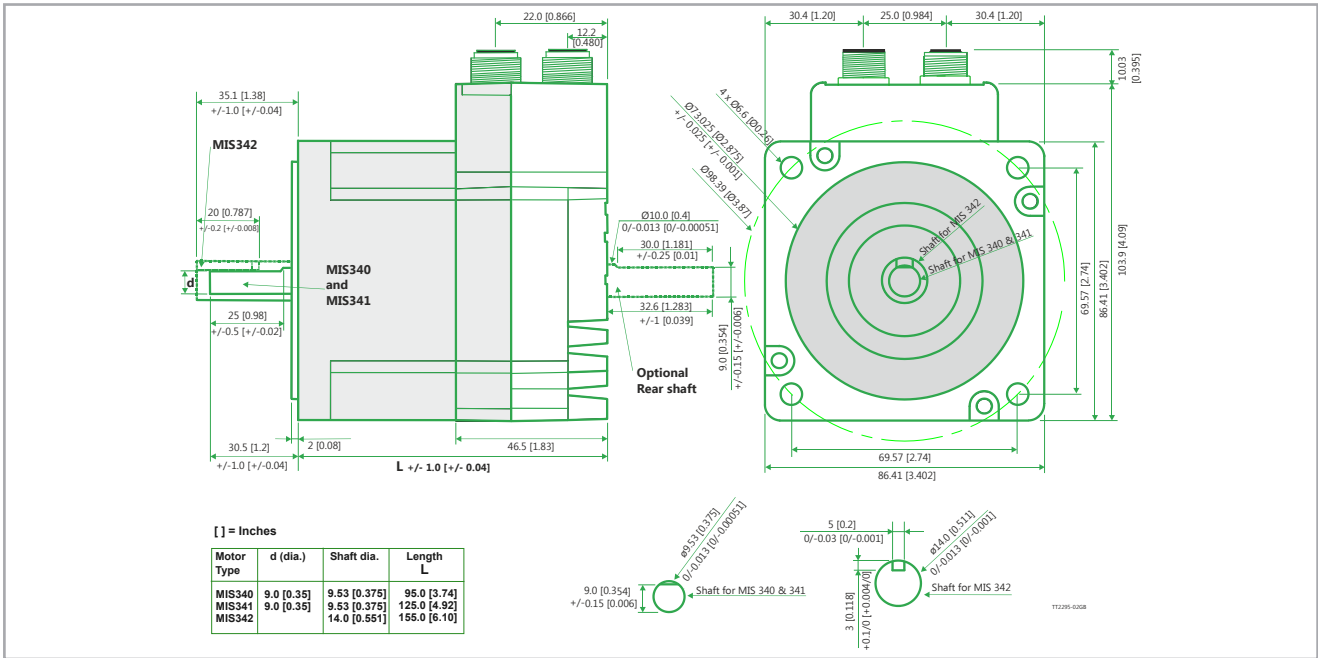

# Planetary gearheads

- Sealed Ball Bearings
- High Reliability, High Efficiency Design
- NEMA Mounting Standards
- High Shaft Loading Capacity
- Low Backlash Design
- Strong, Caged Roller Bearings
- Precision Input Pinion with Balanced Clamp Collar

# HTRG type gears:

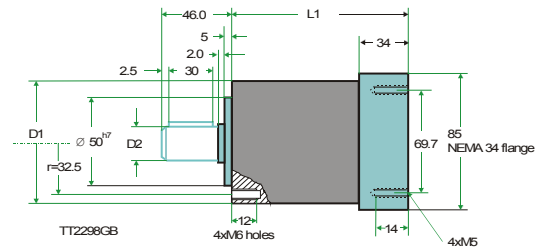

Model.	Backlash [arc min]	Gear ratio	Efficiency [%]	Rated torque >10000 Hours [Nm]	Emerg stop torque [Nm]	Inertia at motor shaft [kg*cm <sup>2</sup> ]	Noise [dB(A)]	Radial load @ 12mm [N]	Axial load [N]	Weight [kg]	L1 [mm]	D1 [mm]	D2 [mm] (h7)
<b>MIS340 and MIS341:</b>													
HTRG08N003MHN34109J	<15	3	97	40	180	0.50	<70	1300	1400	4.0	117.5	85	19
HTRG08N005MHN34109J	<15	5	97	50	200	0.28	<70	1300	1400	4.0	117.5	85	19
HTRG08N010MHN34109J	<15	10	94	40	180	0.20	<70	1300	1400	4.6	142.0	85	19
HTRG08N020MHN34109J	<15	20	94	70	250	0.27	<70	1300	1400	4.6	142.0	85	19
<b>MIS342:</b>													
HTRG08N003MHN34114M	<15	3	97	40	180	0.59	<70	1300	1400	4.0	117.5	85	19
HTRG08N005MHN34114M	<15	5	97	50	200	0.37	<70	1300	1400	4.0	117.5	85	19
HTRG08N010MHN34114M	<15	10	94	40	180	0.29	<70	1300	1400	4.6	142.0	85	19
HTRG08N012MHN34114M	<15	12	94	70	250	0.56	<70	1300	1400	4.6	142.0	85	19

# Get started quickly!

**Starter Kit (MIS340C12Q5H285KIT):**  
**Contains all necessary parts to get started**

- The kit consists of:  
 PA0160 - Test box with I/O and encoder emulation.  
 WI0036 - Cable between test box and QuickStep motor.  
 MIS340C12Q5H285KIT - Integrated step motor.  
 RS485-M12-1-5-5 - cable between QuickStep motor and USB converter.  
 RS485-USB-ATC-820 - USB to RS485 adaptor.  
 PSU024-060-M12 - 24 VDC Power supply. 60W.  
 MacTalk - Windows software for setup and programming.



JVL Industri Elektronik A/S  
 Blokken 42  
 DK-3460 Birkerød, Denmark  
 Tel: +45 4582 4440  
 E-mail: jvl@jvl.dk www.jvl.dk

JVL Deutschland  
 Tel: +49 7121 1377260  
 E-mail: jan.tausend@jvl.dk  
 www.jvl drives.de

JVL USA  
 Tel: +1 513/877-3134  
 E-mail: mfisher@jvlusa.com  
 www.jvlusa.com

