

Installation Guide

Controller Series E1001/E2001/E4001 V3



Products

- E1001-AT(-ME) / -MT(-ME) / -DN(-ME) / -CO(-ME)
- E2001-AT(-ME) / -MT(-ME) / -DN(-ME) / -CO(-ME)
- E4001-AT(-ME) / -MT(-ME) / -DN(-ME) / -CO(-ME)

Content

IMPORTANT NOTES FOR E1001/E2001/E4001 SERIES CONTROLLERS 2

SYSTEM OVERVIEW..... 3

E1001 SERIES FUNCTION AND WIRING 4

POWER SUPPLY AND GROUNDING 5

DESCRIPTION OF THE CONNECTORS / INTERFACES 6

MECHANICAL DIMENSIONS..... 10

POWER SUPPLY REQUIREMENT 11

REGENERATION OF POWER / REGENERATION RESISTOR..... 11

ORDERING INFORMATION 12

DECLARATION OF CONFORMITY CE-MARKING 13

ERROR CODES 14

STATE MACHINE 16

CONTACT ADDRESSES 17

Important Notes for E1001/E2001/E4001 Series Controllers

CAUTION!



In order to assure a safe and error free operation, and to avoid severe damage to system components, all system components must be directly attached to a single ground bus that is earth or utility grounded.



Each system component should be tied directly to the ground bus (star pattern), rather than daisy chaining from component to component. (LinMot motors are properly grounded through their power cables when connected to LinMot controllers.)



All connectors must not be connected or disconnected while DC voltage is present. Do not disconnect system components until all LinMot controllers LED's have turned off. (Capacitors in the power supply may not fully discharge for several minutes after input voltage has been disconnected). Failure to observe these precautions may result in severe damage to electronic components in LinMot motors and/or controllers.



Do not switch Power Supply DC Voltage. All power supply switching and E-Stop breaks should be done to the AC supply voltage of the power supply.



Do not connect or disconnect the motors from controllers with voltage present. Wait to connect or disconnect motors until all LinMot controllers LED's have turned off. (Capacitors may not fully discharge for several minutes after power has been turned off). Failure to observe these precautions may result in severe damage to electronic components in LinMot motors and/or controllers.

© 2010 NTI Ltd

This work is protected by copyright.

Under the copyright laws, this publication may not be reproduced or transmitted in any form, electronic or mechanical, including photocopying, recording, microfilm, storing in an information retrieval system, not even for didactical use, or translating, in whole or in part, without the prior written consent of NTI AG.

LinMot® is a registered trademark of NTI AG.

Note

The information in this documentation reflects the stage of development at the time of press and is therefore without obligation.

NTI AG reserves itself the right to make changes at any time and without notice to reflect further technical advance or product improvement.

System Overview

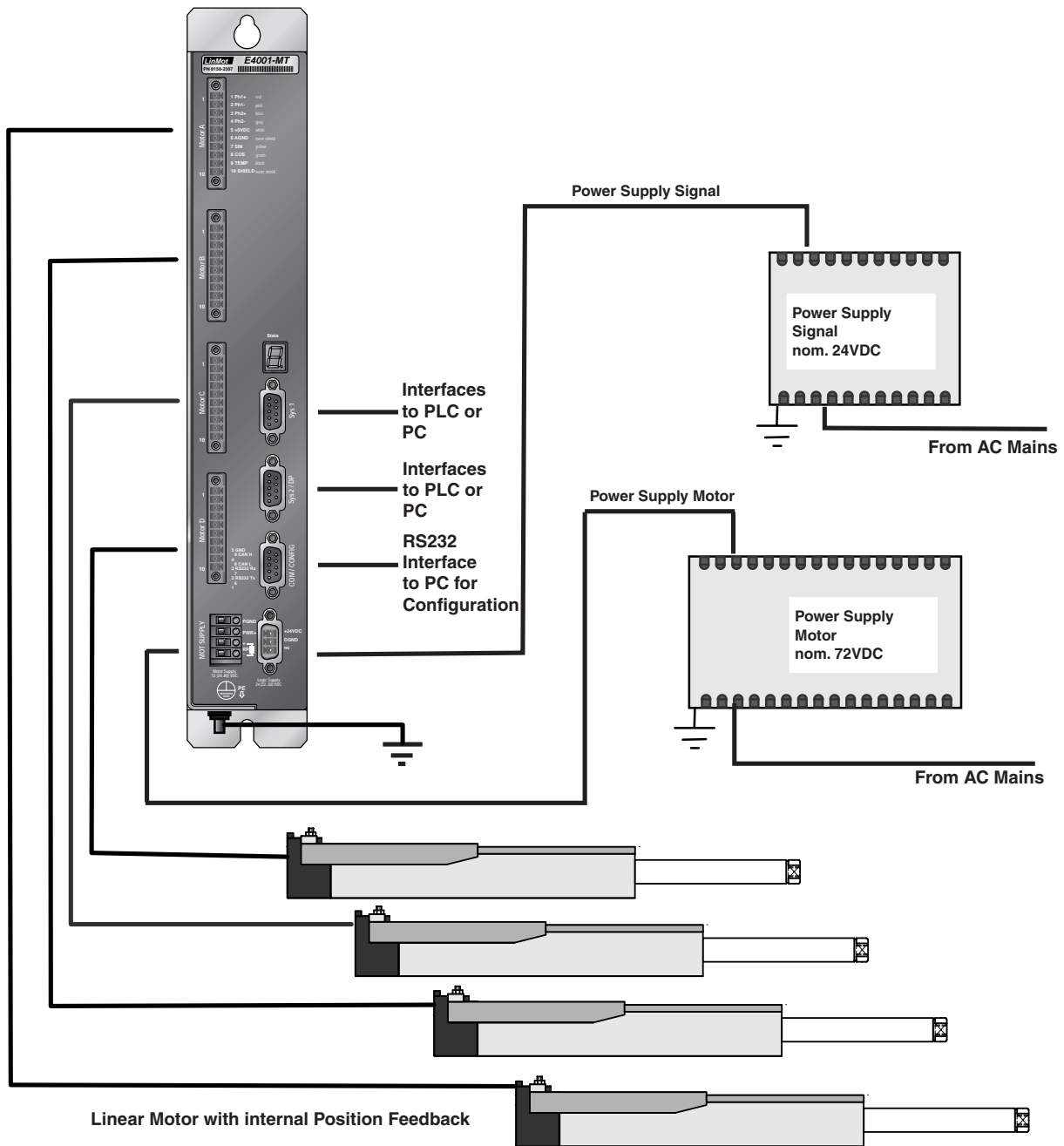

Complete E4001 controller based system (E1001 and E2001 controllers will only drive one respectively two motors).

E1001 Series Function and Wiring

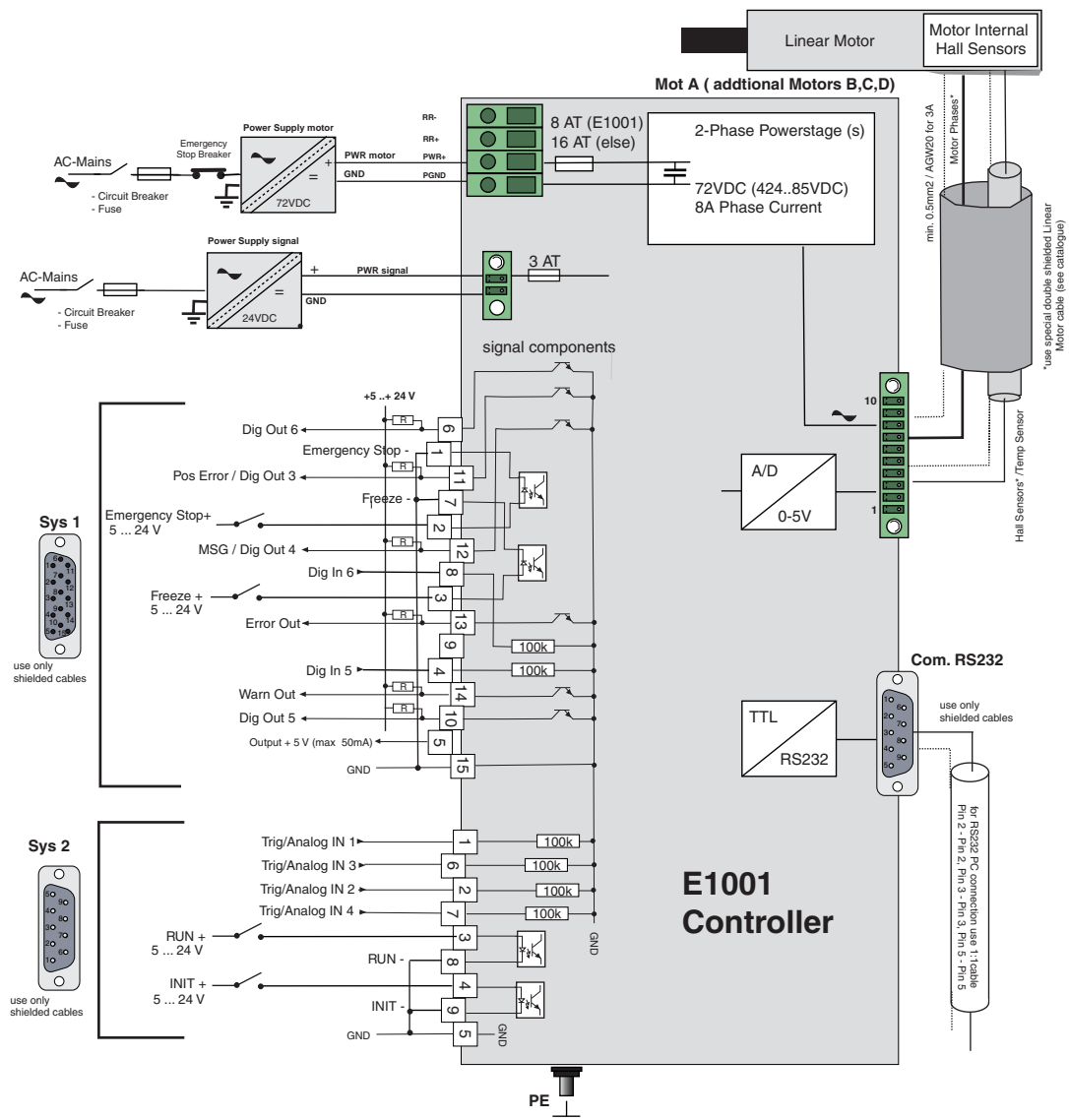

Typical wiring of a single axes controller. Multiple axes controller will have additional motor connectors.

Power Supply and Grounding

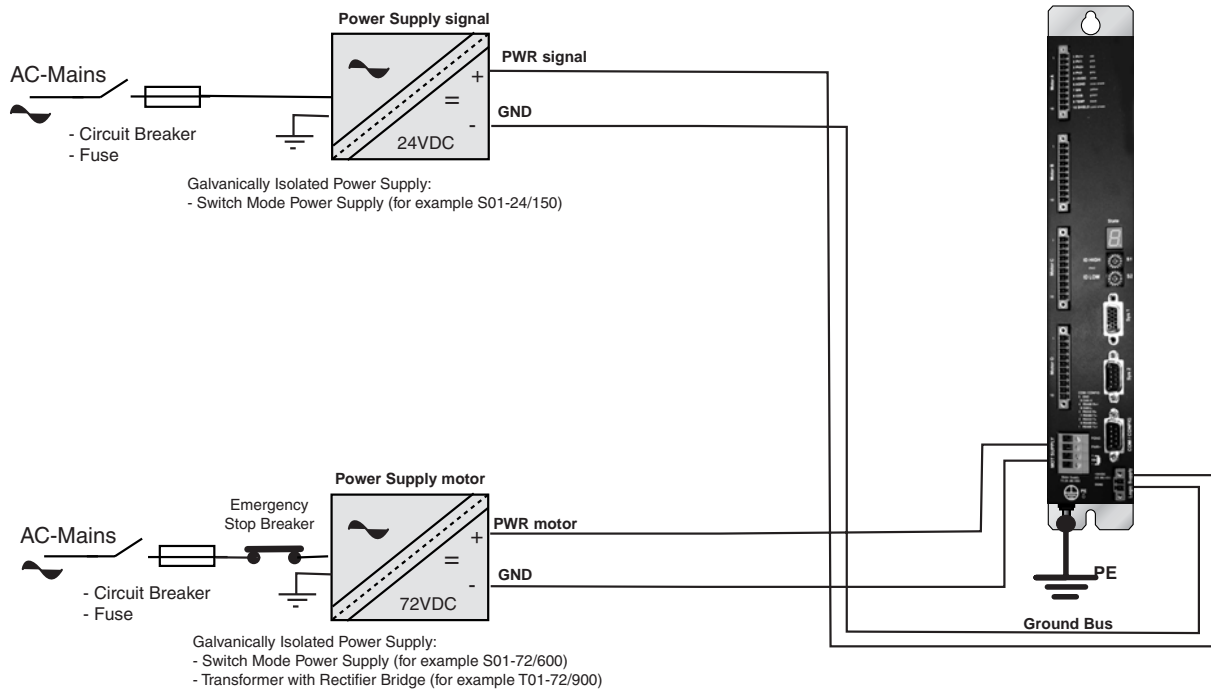

In order to assure a safe and error free operation, and to avoid severe damage to system components, **all system components must be well grounded to either a single earth or utility ground.** This includes both LinMot and all other control system components to the same ground bus.



Each system component should be tied directly to the ground bus (**star pattern**), rather than daisy chaining from component to component. (LinMot motors are properly grounded through their power cables when connected to LinMot controllers.)





Power supply connectors must not be connected or disconnected while DC voltage is present. Do not disconnect system components until all LinMot controllers LED's have turned off. (Capacitors in the power supply may not fully discharge for several minutes after input voltage has been disconnected). Failure to observe these precautions may result in severe damage to electronic components in LinMot motors and/or controllers.



Do not switch Power Supply DC Voltage. All power supply switching and E-Stop breaks should be done to the AC supply voltage of the power supply. Failure to observe these precautions may result in severe damage to controller.

Description of the connectors / Interfaces

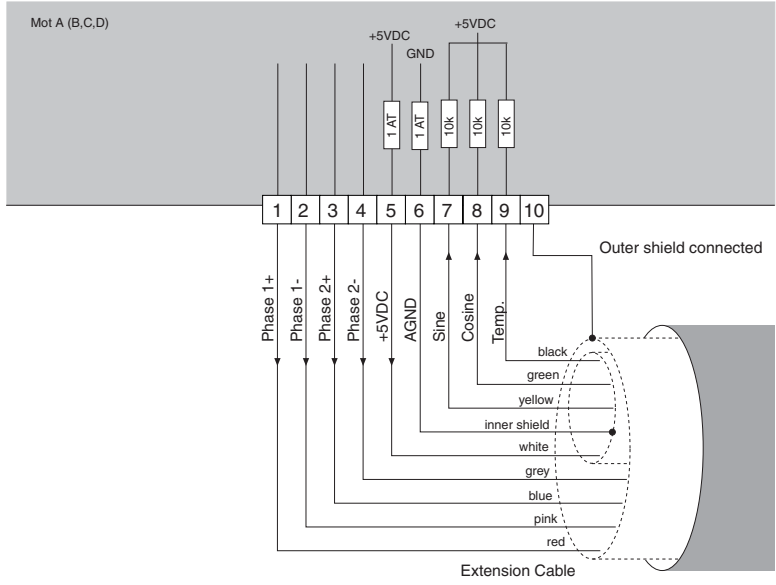
Power Supply																			
<p>Motor Supply</p>	<p>- Tightening torque: min 0.4Nm - Screw thread: M 2,5 - Conductor cross section max. 2.5mm²</p> <p>- Internal Fuse: E4001/E2001: 16AT (Schurter SMD-SPT, 0001.2716.xx, UL File Number: E41599) E1001: 8AT (Schurter SMD-SPT, 0001.2713.xx, UL File Number: E41599)</p>																		
<p>Logic Supply</p>	<p>Pin: 2 Logic Power Supply 24VDC (22..53VDC) 1 Logic GROUND</p> <p>Plug component (Phoenix Contact, MC 1,5/ 2-STF-3,81): - Tightening torque: min 0.22Nm - Screw thread: M 2 - Conductor cross section max. 1.5mm²</p> <p>- Internal Fuse: 3AT (Schurter OMT125, 3404.0118.xx, UL File Number: E41599)</p>																		
 	<p>Power Supply Motor: Wiring: 2.5 mm² (AWG12), max length 5 m Nominal Supply Voltage 72VDC (24...85VDC). Absolute max. Rating is 92 VDC</p> <p>Motor Supply PGND should NOT be externally connected to earth!</p> <p>Power Supply Signal: Wiring: 1.5 mm² (AWG16), max length 5 m Supply Voltage 24...48VDC. Absolute max. Rating 48VDC + 10%</p> <p>Caution: By exceeding 53VDC Power Supply Signal, the controller will go into error state, voltage higher than 55 VDC will damage the controller! By exceeding 92 VDC Motor Supply Signal, the controller will go into error state, voltage higher than 100VDC will damage the controller! Do not switch Power Supply DC Voltage. All power supply switching and E-Stop breaks should be done to the AC supply voltage of the power supplies Power supply connectors <u>must not be connected or disconnected</u> while DC voltage is present.</p>																		
7-Segment Display	State Display																		
<p>Red 7-Segment Display</p>	<table border="1"> <thead> <tr> <th>State:</th> <th>Description:</th> </tr> </thead> <tbody> <tr> <td>-</td> <td>Firmware stopped</td> </tr> <tr> <td>0</td> <td>WAIT FOR DISABLE State</td> </tr> <tr> <td>1</td> <td>DISABLE State (Init not Done)</td> </tr> <tr> <td>2</td> <td>DISABLE State (Init Done)</td> </tr> <tr> <td>7</td> <td>STOP State</td> </tr> <tr> <td>8</td> <td>RUN State</td> </tr> <tr> <td>9</td> <td>INIT State</td> </tr> <tr> <td>Exxxx</td> <td>Error State (See Chapter Error Codes on page 14 for further description)</td> </tr> </tbody> </table> <p>If a warning is active, the display is blinking!</p>	State:	Description:	-	Firmware stopped	0	WAIT FOR DISABLE State	1	DISABLE State (Init not Done)	2	DISABLE State (Init Done)	7	STOP State	8	RUN State	9	INIT State	Exxxx	Error State (See Chapter Error Codes on page 14 for further description)
State:	Description:																		
-	Firmware stopped																		
0	WAIT FOR DISABLE State																		
1	DISABLE State (Init not Done)																		
2	DISABLE State (Init Done)																		
7	STOP State																		
8	RUN State																		
9	INIT State																		
Exxxx	Error State (See Chapter Error Codes on page 14 for further description)																		

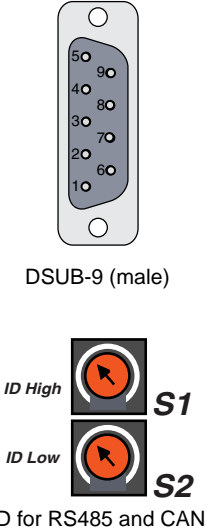
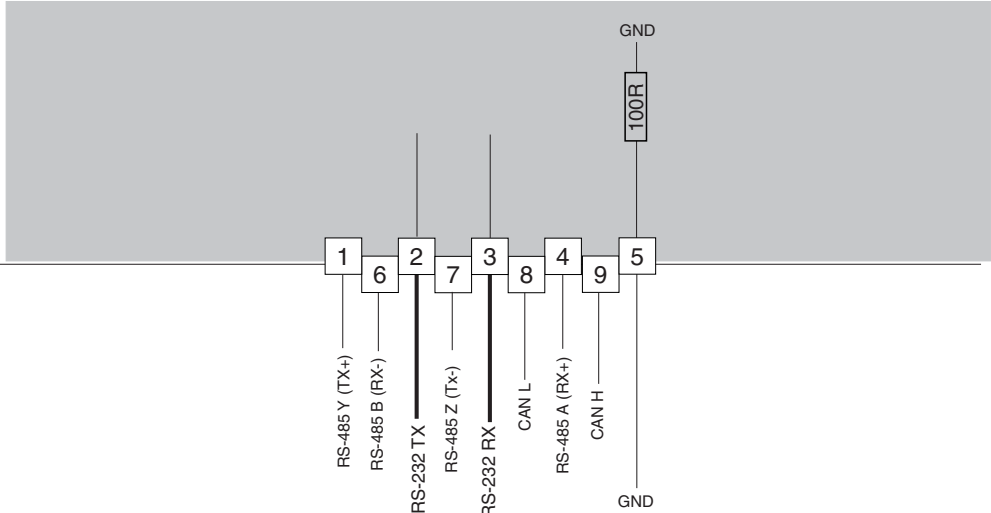
Mot A (B,C,D)	Motor Connector
	
	<p>Note:</p> <ul style="list-style-type: none"> - Use only special double-shielded Linear Motor Cable (see datasheet 'extension cables') - Use +5V (Pin 3) and AGND (Pin 6) only for the motor internal sensor supply (max. 100mA). - Do NOT connect AGND (Pin 6) to ground, earth or outer cable shield! - Inner shield (AGND) and outer shield (earth) must be isolated to each other. <p>Caution:</p> <ul style="list-style-type: none"> - Wrong Motor wiring may damage Linear Motors and/or Servo Controller. - If you are assembling motor cables by your own, double check motor wiring carefully before power up. <p><u>Do not connect or disconnect the motors from controllers with voltage present.</u> Wait to connect or disconnect motors until all LinMot controller LED's have turned off. (Capacitors may not fully discharge for several minutes after power has been turned off). Failure to observe these precautions may result in severe damage to electronic components in LinMot motors and/or controllers. Depending on the environment the outer shield of the motor cable should be directly connected to the control cabinet where the controller is built in to get the best EMC results.</p>
Com / Config	COM (RS-232, RS-485, CAN)
 <p>DSUB-9 (male)</p> <p>ID High S1</p> <p>ID Low S2</p> <p>ID for RS485 and CAN</p>	 <p style="text-align: center;">⚠ Use 1:1 Cable to connect to PC!</p>
	<p><u>RS232:</u> 9.6kBaud, use 1:1 connection cable to PC RS485 and CAN needs external termination (see manual)</p>

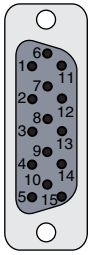
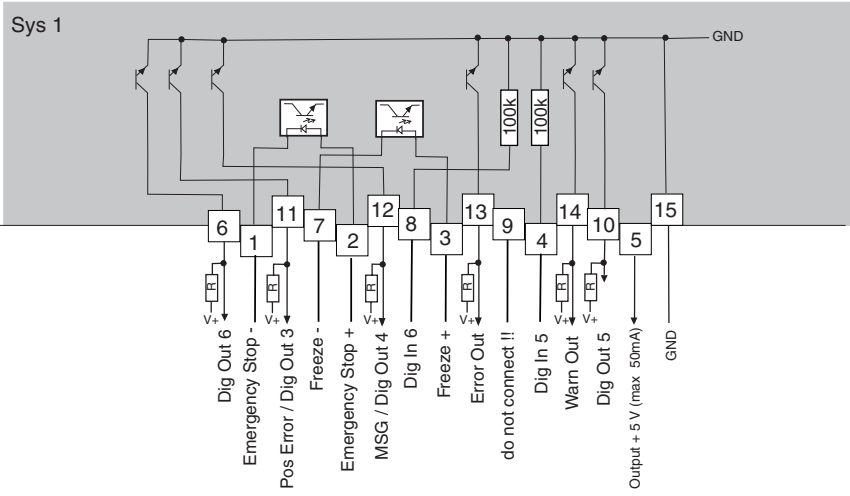
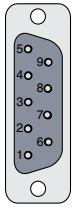
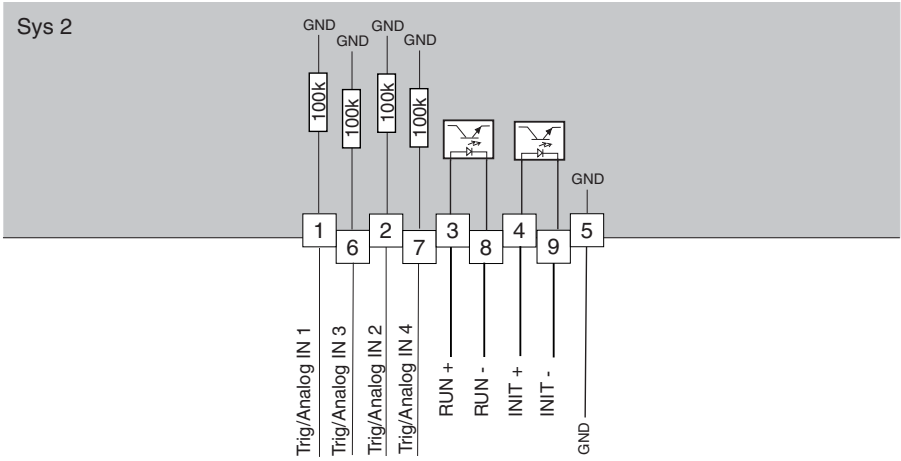
Sys 1	System Connector 1
 DSUB-15 (female)	
	<p><u>Emergency Stop (active low) / Freeze input (active high)</u> Optical isolated inputs Input voltage: 0 ... 24V for logical zero < 2V for logical one > 3.5V Input current: < 20 mA (internally limited to 20 mA) Update rate: 1.6 ms</p> <p><u>Dig In 5 / Dig In 6</u> max. 24V input resistance 100kOhm logical zero < 2V logical one > 3.5V</p> <p><u>Dig Outputs: Dig Out 6, Pos Error Out, MSG, Error Out, Warn Out, Dig Out 5</u> Open Collector max 24V / 50 mA)</p> <p>Typical pull-up Resistor R: for V+ = 5V supply: R= 150 Ohm / 0.25 W For V+ = 24V supply: R=820 Ohm / 1W</p>
Sys 2	System Connector Sys2
 DSUB-9 (male)	
	<p><u>Trig/Analog IN</u> Input can be used as analog inputs between 0 ... 10V (10 bit resolution) input resistance 100kOhm or digital inputs (max. 24V, input resistance 100kOhm) for logical zero < 2V for logical one > 3.5V</p> <p><u>RUN (active high) / INIT (active high)</u> Optically isolated inputs Input voltage: 0 ... 24V for logical zero < 2V for logical one > 3.5V Input current: < 20 mA (internally limited to 20 mA) Update rate: 1.6 ms</p>

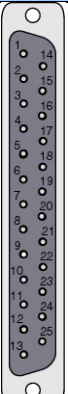
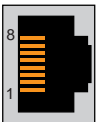
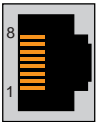
ME Control I/O		Master Encoder Control I/O			
 <p>DSUB 25 female</p>	Pin		Pin		
	1	-	14	VCC ENC IN	
	2	+5V ENC OUT	15	GND ENC	
	3	-	16	DIG IN 1	
	4	DIG IN 2	17	DIG IN 3	
	5	DIG IN 4	18	DIG IN 5	
	6	DIG IN 6	19	DIG IN 7	
	7	DIG IN 8	20	GND DIG IN	
	8	-	21	VCC DIG OUT	
	9	DIG OUT 1	22	DIG OUT 2	
	10	DIG OUT 3	23	DIG OUT 4	
	11	DIG OUT 5	24	DIG OUT 6	
	12	DIG OUT 7	25	DIG OUT 8	
	13	GND DIG OUT			
Further details can be found on the Master Encoder User manual					
ME Link A		Master Encoder Link A			
 <p>RJ45-8</p>		<u>Incremental:</u>	<u>Step/Direction:</u>		<u>EIA/TIA 568A colors:</u>
	1	A+	Step+		Green/White
	2	A-	Step-		Green
	3	B+	Direction+		Orange/White
	4	Z+	Zero-		Blue
	5	Z-	Zero+		Blue/White
	6	B-	Direction-		Orange
	7	VCC ENC	VCC ENC		Brown/White
	8	GND ENC	GND ENC		Brown
	case	Shield	Shield		
Further details can be found on the Master Encoder User manual					
<u>Adapter Cable from RJ45 to DSUB-9 (which was used on the Master Encoder Extension Board on the E4000 series controller has article number 0150-1866)</u>					
ME Link B		Master Encoder Link B			
 <p>RJ45-8</p>		<u>Incremental:</u>	<u>Step/Direction:</u>	<u>Loop Through:</u>	<u>EIA/TIA 568A colors:</u>
	1	A+	Step+	Link A pin 1	Green/White
	2	A-	Step-	Link A pin 2	Green
	3	B+	Direction+	Link A pin 3	Orange/White
	4	Z+	Zero-	Link A pin 4	Blue
	5	Z-	Zero+	Link A pin 5	Blue/White
	6	B-	Direction-	Link A pin 6	Orange
	7	VCC ENC	VCC ENC	VCC ENC	Brown/White
	8	GND ENC	GND ENC	VCC ENC	Brown
	case	Shield	Shield	Shield	
Further details can be found on the Master Encoder User manual					
<u>Adapter Cable from RJ45 to DSUB-9 (which was used on the Master Encoder Extension Board on the E4000 series controller has article number 0150-1867)</u>					

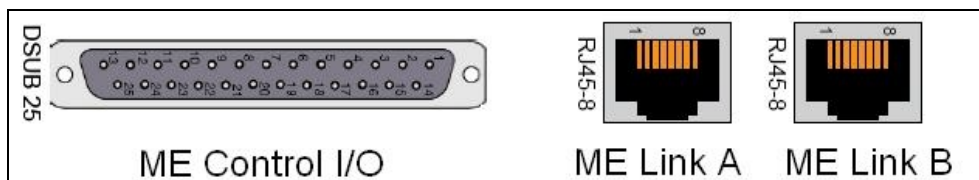

Bottom view of the master encoder connectors

Mechanical Dimensions

Dimensions

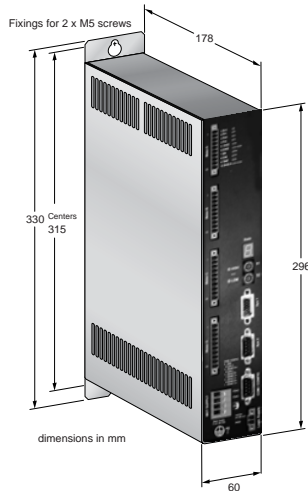

Recommended mounting for multiple controller installations

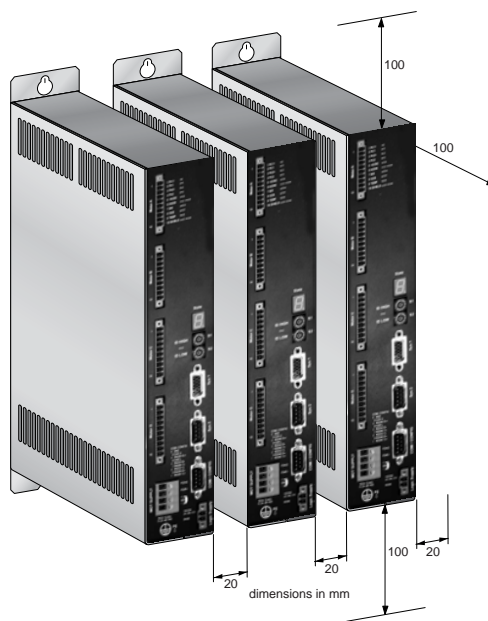

		E1001 <i>Single axes controller</i>	E2001 <i>2 axes controller</i>	E4001 <i>4 axes controller</i>
Width	mm (in)		60 (2.4)	
Height	mm (in)		330 (13)	
Height without fixings	mm (in)		296 (11.7)	
Depth	mm (in)		178 (7)	
Weight	Kg (lb)		2.5 (5.5)	
Case	IP		20	
Storage Temperature	°C		-25...40	
Transport Temperature	°C		-25..70	
Operating Temperature	°C		0...40	
Max. Case Temperature	°C		65	

Power Supply Requirement

Power Supply motor

The calculation of the needed power for the motor supply depends on the application and the used motor. The nominal supply voltage is 72 VDC. The possible range is from 24...85VDC.



ATTENTION: The motor supply can rise up to 95 VDC when braking. This means that everything connected to that power supply needs a voltage rating of 100 VDC. (Power supply itself, additional capacitors, etc...)

For the same reason, the 24VDC supply for the signal, shall not be connected together with the motor supply. If the motor is supplied with 24 VDC, this must be an additional, independent power supply.

Recommended Power supplies:

Item	Description	Art. No.
T01-72/420	72VDC, 15A peak, 420VA, 3x400VAC	0150-1966
T01-72/420-US	72VDC, 15A peak, 420VA, 3x230VAC	0150-1967
T01-72/900	72VDC, 30A peak, 900VA, 3x400VAC	0150-1842
T01-72/900-US	72VDC, 30A peak, 900VA, 3x230VAC	0150-1843
T01-72/1500	72VDC, 2x30A peak, 1500VA, 3x400VAC	0150-1844
T01-72/1500-US	72VDC, 2x30A peak, 1500VA, 3x230VAC	0150-1845

Power Supply signal

The logic supply needs a regulated power supply of a nominal voltage of 24 VDC. The voltage must be between 22 and 48VDC.

Power consumption: 10W

Regeneration of Power / Regeneration Resistor

There are two possibilities handle power regeneration:

Option A: Connect an additional capacitor to the motor power supply. It is recommended to use a capacitor $\geq 10'000 \mu\text{F}$ (install capacitor close to the power supply!)

Option B: Install a Regeneration Resistor to X1 (RR+ and RR-). The threshold value of the voltage depends on the used motor voltage power supply. The max. threshold value must not exceed 88 VDC.

Item	Description	Art. No.
Capacitor	Capacitor 10'000 μF / 100 V	0150-3075
Regeneration Resistor	RR01-10/60 (10 Ohm, 60 W)	0150-3088
Regeneration Resistor	RR01-10/150 (10 Ohm, 150 W)	0150-3090

Ordering Information

Servo Controller	Description	Art. No.
E1001-AT	Analog Trigger Controller 1 Axis (72V/8A)	0150-2300
E1001-MT	Multi Trigger Controller 1 Axis (72V/8A)	0150-2304
E1001-DN	DeviceNet Controller 1 Axis (72V/8A)	0150-2312
E1001-CO	CanOpen Controller 1 Axis (72V/8A)	0150-2308
E1001-AT-ME	Analog Trigger Controller 1 Axis (72V/8A) with integrated ME	0150-2320
E1001-MT-ME	Multi Trigger Controller 1 Axis (72V/8A) with integrated ME	0150-2324
E1001-DN-ME	DeviceNet Controller 1 Axis (72V/8A) with integrated ME	0150-2332
E1001-CO-ME	CanOpen Controller 1 Axis (72V/8A) with integrated ME	0150-2328
E2001-AT	Analog Trigger Controller 2 Axis (72V/8A)	0150-2301
E2001-MT	Multi Trigger Controller 2 Axis (72V/8A)	0150-2305
E2001-DN	DeviceNet Controller 2 Axis (72V/8A)	0150-2313
E2001-CO	CanOpen Controller 2 Axis (72V/8A)	0150-2309
E2001-AT-ME	Analog Trigger Controller 2 Axis (72V/8A) with integrated ME	0150-2321
E2001-MT-ME	Multi Trigger Controller 2 Axis (72V/8A) with integrated ME	0150-2325
E2001-DN-ME	DeviceNet Controller 2 Axis (72V/8A) with integrated ME	0150-2333
E2001-CO-ME	CanOpen Controller 2 Axis (72V/8A) with integrated ME	0150-2329
E4001-AT	Analog Trigger Controller 4 Axis (72V/8A)	0150-2303
E4001-MT	Multi Trigger Controller 4 Axis (72V/8A)	0150-2307
E4001-DN	DeviceNet Controller 4 Axis (72V/8A)	0150-2315
E4001-CO	CanOpen Controller 4 Axis (72V/8A)	0150-2311
E4001-AT-ME	Analog Trigger Controller 4 Axis (72V/8A) with integrated ME	0150-2323
E4001-MT-ME	Multi Trigger Controller 4 Axis (72V/8A) with integrated ME	0150-2327
E4001-DN-ME	DeviceNet Controller 4 Axis (72V/8A) with integrated ME	0150-2335
E4001-CO-ME	CanOpen Controller 4 Axis (72V/8A) with integrated ME	0150-2331

Declaration of Conformity CE-Marking

Manufacturer: NTI AG
 LinMot®
 Haerdlistrasse 15
 CH-8957 Spreitenbach
 Switzerland
 Tel.: +41 (0)56 419 91 91
 Fax: +41 (0)56 419 91 92

Products: LinMot® Controllers E1001 series

Type	Art.-No.	Type	Art.-No.	Type	Art.-No.
E1001-AT	0150-2300	E2001-AT	0150-2301	E4001-AT	0150-2303
E1001-MT	0150-2304	E2001-MT	0150-2305	E4001-MT	0150-2307
E1001-DN	0150-2312	E2001-DN	0150-2313	E4001-DN	0150-2315
E1001-CO	0150-2308	E2001-CO	0150-2309	E4001-CO	0150-2311
E1001-AT-ME	0150-2320	E2001-AT-ME	0150-2321	E4001-AT-ME	0150-2323
E1001-MT-ME	0150-2324	E2001-MT-ME	0150-2325	E4001-MT-ME	0150-2327
E1001-DN-ME	0150-2332	E2001-DN-ME	0150-2333	E4001-DN-ME	0150-2335
E1001-CO-ME	0150-2328	E2001-CO-ME	0150-2329	E4001-CO-ME	0150-2331

The product must be mounted and used in strict accordance with the installation instruction contained within the User's Manual, a copy of which may be obtained from NTI AG.

I declare that as the authorized representative, the above information in relation to the supply/manufacture of this product is in conformity with the stated standards and other related documents in compliance with the protection requirements of the Electromagnetic Compatibility (EMC) Directive 2004/108/EC.

Standards Complied with:

EMI	EN 55011	Class A
EN 61000-6-4		
Electromagnetic	EN 61000-4-2	4 kV / 8kV
Susceptibility EMC	EN 61000-4-4	1 kV / 2kV
EN 61000-6-2	EN 61000-4-3	10 V/m
	EN 61000-4-6	10 V
	ENV 50204	10 V/m

Company
 NTI AG

Spreitenbach, July 28, 2010



 R. Rohner / CEO NTI AG

Error codes

In the Error State the controller displays the error code by the 7-segment display:

Code	Description
E0001	Missing or invalid parameter tree
E0002	Missing or invalid application
E0003	Controller type not supported
E0004	MT command interface not available
E0005	Timer watchdog error
E0006	Trap class A error
E0007	Trap class B error
E0008	No master found for slave motor.
E0009	No external sensor defined
E000A	External sensor not allowed on channel D
E000B	The application software needs an MT Electronics
E000C	Noise Dead Band is not supported on this device revision (must be set to 0mm)
E0010	DCLV Power Too Low
E0011	DCLV Power Too High
E0012	DCLV Signal Too Low
E0013	DCLV Signal Too High
E0014	Electronic Fault
E0015	HW Error Internal 12V missing
E0101	Drive A Too Hot Calculated
E0102	Drive A Too Hot Sensor
E0103	Drive A Following Error
E0104	Drive A Slider Missing
E0106	Drive A Init Failed
E0107	Drive A Drive Type Mismatch
E0108	Drive A Curve Error
E0109	Drive A: Board Over Current
E010A	Drive A: Board Over Temperature
E010B	Drive A: AGND or 5VDC Fuse Blown
E0201	Drive B Too Hot Calculated
E0202	Drive B Too Hot Sensor
E0203	Drive B Following Error
E0204	Drive B Slider Missing
E0206	Drive B Init Failed
E0207	Drive B Drive Type Mismatch
E0208	Drive B Curve Error
E0209	Drive B: Board Over Current
E020A	Drive B: Board Over Temperature
E020B	Drive B: AGND or 5VDC Fuse Blown
E0301	Drive C Too Hot Calculated
E0302	Drive C Too Hot Sensor
E0303	Drive C Following Error
E0304	Drive C Slider Missing
E0306	Drive C Init Failed
E0307	Drive C Drive Type Mismatch
E0308	Drive C Curve Error
E0309	Drive C: Board Over Current
E030A	Drive C: Board Over Temperature
E030B	Drive C: AGND or 5VDC Fuse Blown
E0401	Drive D Too Hot Calculated
E0402	Drive D Too Hot Sensor
E0403	Drive D Following Error
E0404	Drive D Slider Missing
E0406	Drive D Init Failed
E0407	Drive D Drive Type Mismatch

Code	Description
E0408	Drive D Curve Error
E0409	Drive D: Board Over Current
E040A	Drive D: Board Over Temperature
E040B	Drive D: AGND or 5VDC Fuse Blown
\$\$FFEC	RAM error
E1001	RTS: State is too long
E1002	RTS: Controller version not supported
E1003	RTS: Wrong firmware
E1004	RTS: No script found
E1005	RTS: Illegal command
E8000	MT: Multitrigger table missing
E8001	MT: Drive A type mismatch
E8002	MT: Drive B type mismatch
E8003	MT: Drive C type mismatch
E8004	MT: Drive D type mismatch
E8100	DN: Application needs DeviceNet controller
E8101	DN: DeviceNet MACID already in use
E8104	DN: Processor speed not supported by SW
E8108	DN: Unknown command
E8110	DN: Drive not specified in command
E8111	DN: Drive is not master
E8112	DN: Drive is not in serial mode
E8118	DN: Range error
E8120	DN: Encoder does not exist
E8121	DN: Encoder is in SSI mode
E8130	DN: Curve does not exist
E8131	DN: Curve type mismatch
E8132	DN: Curve processing
E8140	DN: Unspecified CAN error
E8141	DN: CAN stuff error
E8142	DN: CAN form error
E8143	DN: CAN acknowledge error
E8144	DN: CAN bit1 error
E8145	DN: CAN bit0 error
E8146	DN: CAN CRC error
E8147	DN: CAN message lost
E8148	DN: CAN BOFF erro
E8200	CO: Application needs CANopen controller
E8201	CO: Invalid address
E8202	CO: Data out of range
E8203	CO: Drive is not in serial mode
E8210	CO: Bus error
E8218	CO: Unspecified CAN error
E8219	CO: CAN stuff error
E821A	CO: CAN form error
E821B	CO: CAN acknowledge error
E821C	CO: CAN bit1 error
E821D	CO: CAN bit0 error
E821E	CO: CAN CRC error

State Machine

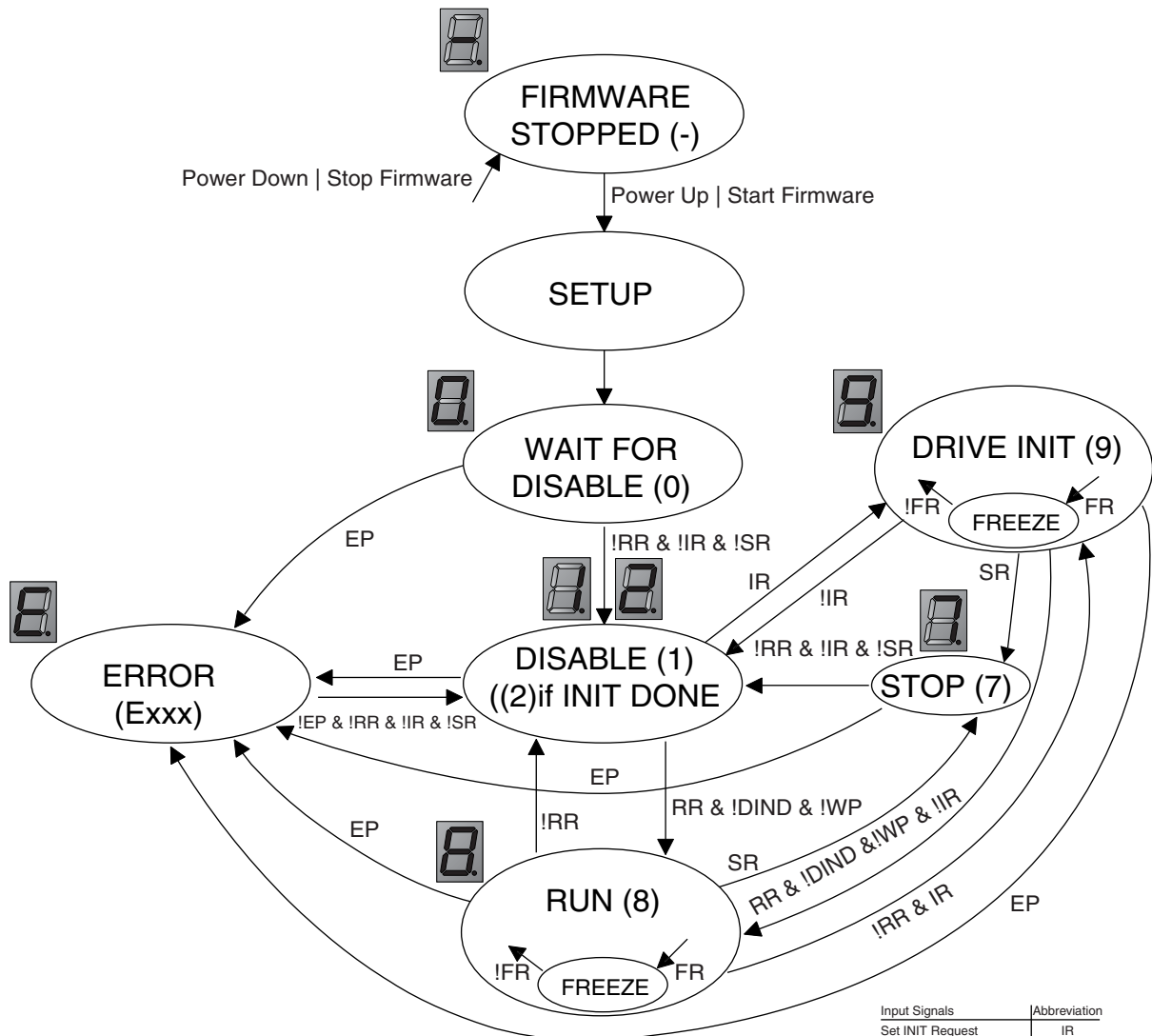

Input signals have to be activated in the parameter tree!
 RUN signal is set in state SETUP. For changing into the state DISABLE, the RUN signal must be cleared from the active interface!

Input Signals	Abbreviation
Set INIT Request	IR
Set RUN Request	RR
Set STOP Request	SR
Set FREEZE Request	FR
Reset INIT Request	!IRR
Reset RUN Request	!RR
Reset STOP Request	!SR
Reset FREEZE Request	!FR
Internal Signals	Abbreviation
DRIVE_INIT_NOT_DONE	DIND
ERROR_PENDING	EP
WARNING_PENDING	WP

Contact Addresses

SWITZERLAND

NTI AG
Haerdlistr. 15
CH-8957 Spreitenbach

Sales and Administration: +41-(0)56-419 91 91
office@linmot.com

Tech. Support: +41-(0)56-544 71 00
support@linmot.com

Tech. Support (Skype) : skype:support.linmot

Fax: +41-(0)56-419 91 92
Web: http://www.linmot.com/

USA

LinMot, Inc.
5750 Townline Road
Elkhorn, WI 53121

Sales and Administration: 877-546-3270
262-743-2555

Tech. Support: 877-804-0718
262-743-1284

Fax: 800-463-8708
262-723-6688

E-Mail: us-sales@linmot.com
Web: http://www.linmot-usa.com/

Please visit <http://www.linmot.com/> to find the distribution near you.

Smart solutions are...

