

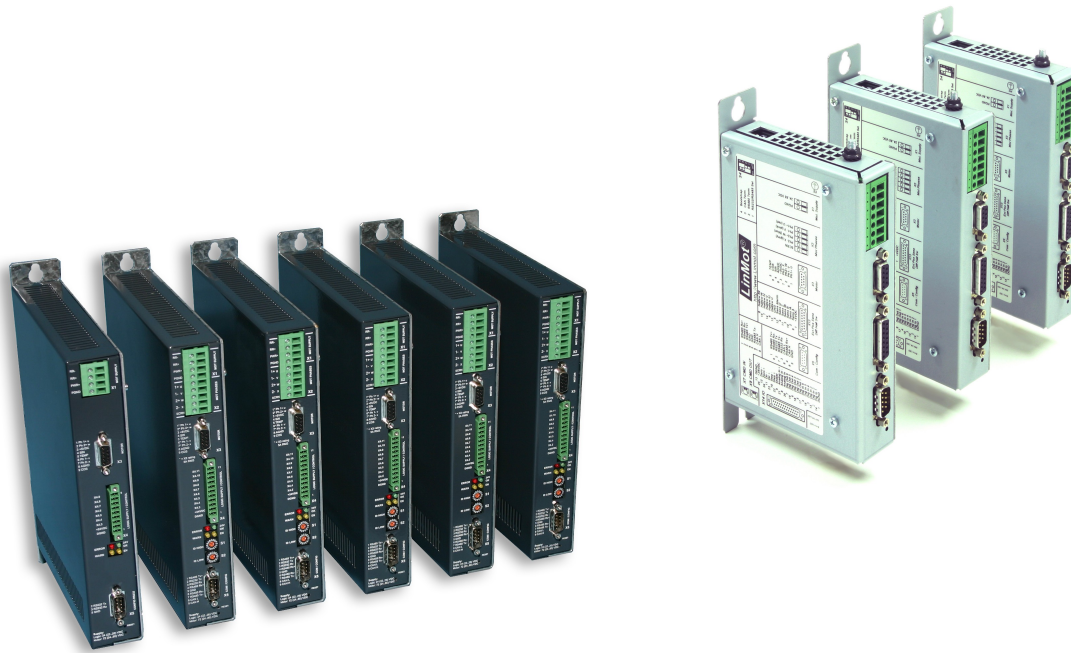

Motion Control SW

Documentation of the Motion Control SW

- E1100 / B1100 Drive Series



Motion Control SW

User Manual

© 2013 NTI AG

This work is protected by copyright.

Under the copyright laws, this publication may not be reproduced or transmitted in any form, electronic or mechanical, including photocopying,

recording, microfilm, storing in an information retrieval system, not even for didactical use, or translating, in whole or in part, without the prior written consent of NTI AG.

LinMot® is a registered trademark of NTI AG.

Note

The information in this documentation reflects the stage of development at the time of press and is therefore without obligation. NTI AG. reserves itself the right to make changes at any time and without notice to reflect further technical advance or product improvement.

Document Version 3.17b / Whp, December 2013

TABLE OF CONTENT

SYSTEM OVERVIEW	9
1.1 REFERENCES	9
1.2 DEFINITIONS, ITEMS, SHORTCUTS	9
1.3 DATA TYPES	9
2 MOTION CONTROL INTERFACES	10
3 STATE MACHINE	11
3.1 STATE 0: NOT READY TO SWITCH ON	13
3.2 STATE 1: SWITCH ON DISABLED	13
3.3 STATE 2: READY TO SWITCH ON	13
3.4 STATE 3: SETUP ERROR STATE	13
3.5 STATE 4: ERROR STATE	13
3.6 STATE 5: HW TEST	13
3.7 STATE 6: READY TO OPERATE	13
3.8 STATE 8: OPERATION ENABLED	14
3.9 STATE 9: HOMING	14
3.10 STATE 10: CLEARANCE CHECK	14
3.11 STATE 11: GOING TO INITIAL POSITION	14
3.12 STATE 12: ABORTING	14
3.13 STATE 13: FREEZING	15
3.14 STATE 14: ERROR BEHAVIOUR QUICK STOP	15
3.15 STATE 15: GOING TO POSITION	15
3.16 STATE 16: JOGGING +	15
3.17 STATE 17: JOGGING -	15
3.18 STATE 18: LINEARIZING	15
3.19 STATE 19: PHASE SEARCHING	15
3.20 STATE 20: SPECIAL MODE	15
3.21 BUILDING THE CONTROL WORD	15
3.22 CONTROL WORD	16
3.23 STATUS WORD	17
3.24 WARN WORD	18
4 MOTION COMMAND INTERFACE	19
4.1 MOTION COMMAND INTERFACE	19
4.1.1 Command Header	19
4.1.1.1 Master ID	19
4.1.1.2 Sub ID	19
4.1.1.3 Command Count	19
4.2 OVERVIEW MOTION COMMANDS	20
4.3 DETAILED MOTION COMMAND DESCRIPTION	25
4.3.1 No Operation (000xh)	25
4.3.2 Write Interface Control Word (001xh)	25
4.3.3 Write Live Parameter (002xh)	25
4.3.4 Write X4 Intf Outputs with Mask (003xh)	25
4.3.5 Write X6 Intf Outputs with Mask (004xh)	25
4.3.6 Clear Event Evaluation (008xh)	26
4.3.7 Master Homing (009xh)	26
4.3.8 VAI Go To Pos (010xh)	26

<u>4.3.9 VAI Increment Dem Pos (011xh)</u>	<u>26</u>
<u>4.3.10 VAI Increment Target Pos (012xh)</u>	<u>27</u>
<u>4.3.11 VAI Go To Pos From Act Pos And Act Vel (013xh)</u>	<u>27</u>
<u>4.3.12 VAI Go To Pos From Act Pos Starting With Dem Vel = 0 (014xh)</u>	<u>27</u>
<u>4.3.13 VAI Increment Act Pos (015xh)</u>	<u>27</u>
<u>4.3.14 VAI Increment Act Pos Starting With Dem Vel = 0 (016xh)</u>	<u>28</u>
<u>4.3.15 VAI Stop (017xh)</u>	<u>28</u>
<u>4.3.16 VAI Go To Pos After Actual Command (018xh)</u>	<u>28</u>
<u>4.3.17 VAI Go To Analog Pos (019xh)</u>	<u>28</u>
<u>4.3.18 VAI Go To Pos On Rising Trigger Event (01Axh)</u>	<u>29</u>
<u>4.3.19 VAI Increment Target Pos On Rising Trigger Event (01Bxh)</u>	<u>29</u>
<u>4.3.20 VAI Go To Pos On Falling Trigger Event (01Cxh)</u>	<u>29</u>
<u>4.3.21 VAI Increment Target Pos On Falling Trigger Event (01Dxh)</u>	<u>29</u>
<u>4.3.22 VAI Change Motion Parameters On Positive Position Transition (01Exh)</u>	<u>29</u>
<u>4.3.23 VAI Change Motion Parameters On Negative Position Transition (01Fhx)</u>	<u>30</u>
<u>4.3.24 Predef VAI Go To Pos (020xh)</u>	<u>30</u>
<u>4.3.25 Predef VAI Increment Dem Pos (021xh)</u>	<u>30</u>
<u>4.3.26 Predef VAI Increment Target Pos (022xh)</u>	<u>30</u>
<u>4.3.27 Predef VAI Go To Pos From Act Pos and Act Vel (023xh)</u>	<u>30</u>
<u>4.3.28 Predef VAI Go To Pos From Act Pos Starting With Dem Vel = 0 (024xh)</u>	<u>31</u>
<u>4.3.29 Predef VAI Stop (027xh)</u>	<u>31</u>
<u>4.3.30 Predef VAI Go To Pos After Actual Command (028xh)</u>	<u>31</u>
<u>4.3.31 Predef VAI Go To Pos On Rising Trigger Event (02Axh)</u>	<u>31</u>
<u>4.3.32 Predef VAI Increment Target Pos On Rising Trigger Event (02Bxh)</u>	<u>31</u>
<u>4.3.33 Predef VAI Go To Pos On Falling Trigger Event (02Cxh)</u>	<u>31</u>
<u>4.3.34 Predef VAI Go To Pos On Falling Trigger Event (02Dxh)</u>	<u>31</u>
<u>4.3.35 Predef VAI Infinite Motion Positive Direction (02Exh)</u>	<u>32</u>
<u>4.3.36 Predef VAI Infinite Motion Negative Direction (02Fhx)</u>	<u>32</u>
<u>4.3.37 P Stream With Slave Generated Time Stamp (030xh)</u>	<u>32</u>
<u>4.3.38 PV Stream With Slave Generated Time Stamp (031xh)</u>	<u>32</u>
<u>4.3.39 P Stream With Slave Generated Time Stamp and Configured Period Time (032xh)</u>	<u>32</u>
<u>4.3.40 Stop Streaming (03Fhx)</u>	<u>33</u>
<u>4.3.41 Time Curve With Default Parameters (040xh)</u>	<u>33</u>
<u>4.3.42 Time Curve With Default Parameters From Act Pos (041xh)</u>	<u>33</u>
<u>4.3.43 Time Curve To Pos With Default Speed (042xh)</u>	<u>33</u>
<u>4.3.44 Time Curve To Pos With Adjustable Time (043xh)</u>	<u>33</u>
<u>4.3.45 Time Curve With Adjustable Offset, Time Scale & Amplitude Scale (044xh)</u>	<u>34</u>
<u>4.3.46 Time Curve With Adjustable Offset, Time & Amplitude Scale (045xh)</u>	<u>34</u>
<u>4.3.47 Time Curve With Adjustable Offset, Time & Amplitude Scale On Rising Trigger Event (046xh)</u>	<u>34</u>
<u>4.3.48 Time Curve With Adjustable Offset, Time & Amplitude Scale On Falling Trigger Event (047xh)</u>	<u>34</u>
<u>4.3.49 Time Curve To Pos With Default Speed On Rising Trigger Event (04Axh)</u>	<u>35</u>
<u>4.3.50 Time Curve To Pos With Default Speed On Falling Trigger Event (04Cxh)</u>	<u>35</u>
<u>4.3.51 Time Curve To Pos With Adjustable Time On Rising Trigger Event (04Exh)</u>	<u>35</u>
<u>4.3.52 Time Curve To Pos With Adjustable Time On Falling Trigger Event (04Fhx)</u>	<u>35</u>
<u>4.3.53 Modify Curve Start Address in RAM (050xh)</u>	<u>35</u>
<u>4.3.54 Modify Curve Info Block 16 Bit Value in RAM (051xh)</u>	<u>36</u>
<u>4.3.55 Modify Curve Info Block 32 Bit Value in RAM (052xh)</u>	<u>36</u>

4.3.56 Modify Curve Data Block 32 Bit Value in RAM (054xh)	37
4.3.57 Modify Curve Data Block 64 Bit Value in RAM (055xh)	37
4.3.58 Modify Curve Data Block 96 Bit Value in RAM (056xh)	38
4.3.59 Setup Encoder Cam On Rising Trigger Event With Delay Counts (069xh)	38
4.3.60 Setup Encoder Cam On Rising Trigger Event With Delay Counts, Target Pos and Length (06Axh)	38
4.3.61 Setup Encoder Cam On Falling Trigger Event With Delay Counts (06Bxh)	39
4.3.62 Setup Encoder Cam On Falling Trigger Event With Delay Counts, Target Pos and Length (06Cxh)	39
4.3.63 Setup Encoder Cam On Rising Trigger Event With Delay Counts, Amplitude scale and Length (06Dxh)	39
4.3.64 Setup Encoder Cam On Falling Trigger Event With Delay Counts, Amplitude scale and Length (06Exh)	40
4.3.65 Start VAI Encoder Position Indexing (070xh)	40
4.3.66 Start Predef VAI Encoder Position Indexing (071xh)	40
4.3.67 Stop Position Indexing and VAI Go To Pos (07Exh)	40
4.3.68 Stop Position Indexing and VAI Go To Pos (07Fxh)	41
4.3.69 VAI 16 Bit Go To Pos (090xh)	41
4.3.70 VAI 16 Bit Increment Dem Pos (091xh)	41
4.3.71 VAI 16 Bit Increment Target Pos (092xh)	41
4.3.72 VAI 16 Bit Go To Pos From Act Pos And Act Vel (093xh)	42
4.3.73 VAI 16 Bit Go To Pos From Act Pos Starting With Dem Vel = 0 (094xh)	42
4.3.74 VAI 16 Bit Increment Act Pos (095xh)	42
4.3.75 VAI 16 Bit Increment Act Pos Starting With Dem Vel = 0 (096xh)	42
4.3.76 VAI 16 Bit Stop (097xh)	42
4.3.77 VAI 16 Bit Go To Pos After Actual Command (098xh)	43
4.3.78 VAI 16 Bit Go To Pos On Rising Trigger Event (09Axh)	43
4.3.79 VAI 16 Bit Increment Target Pos On Rising Trigger Event (09Bxh)	43
4.3.80 VAI 16 Bit Go To Pos On Falling Trigger Event (09Cxh)	43
4.3.81 VAI 16 Bit Increment Target Pos On Falling Trigger Event (09Dxh)	44
4.3.82 VAI 16 Bit Change Motion Parameters On Positive Position Transition (09Exh)	44
4.3.83 VAI 16 Bit Change Motion Parameters On Negative Position Transition (09Fxh)	44
4.3.84 Predef VAI 16 Bit Go To Pos (0A0xh)	44
4.3.85 Predef VAI 16 Bit Increment Dem Pos (0A1xh)	45
4.3.86 Predef VAI 16 Bit Increment Target Pos (0A2xh)	45
4.3.87 Predef VAI 16 Bit Go To Pos From Act Pos And Act Vel (0A3xh)	45
4.3.88 Predef VAI 16 Bit Go To Pos From Act Pos Starting With Dem Vel = 0 (0A4xh)	45
4.3.89 Predef VAI 16 Bit Stop (0A7xh)	45
4.3.90 Predef VAI 16 Bit Go To Pos After Actual Command (0A8xh)	45
4.3.91 Predef VAI 16 Bit Go To Pos On Rising Trigger Event (0AAxh)	46
4.3.92 Predef VAI 16 Bit Increment Target Pos On Rising Trigger Event (0ABxh)	46
4.3.93 Predef VAI 16 Bit Go To Pos On Falling Trigger Event (0ACxh)	46
4.3.94 Predef VAI 16 Bit Increment Target Pos On Falling Trigger Event (0ADxh)	46
4.3.95 VAI Predef Acc Go To Pos (0B0xh)	46
4.3.96 VAI Predef Acc Increment Dem Pos (0B1xh)	46
4.3.97 VAI Predef Acc Increment Target Pos (0B2xh)	46
4.3.98 VAI Predef Acc Go To Pos From Act Pos And Act Vel (0B3xh)	47

4.3.99 VAI Predef Acc Go To Pos From Act Pos Starting With Dem Vel = 0 (0B4xh)	47
4.3.100 VAI Predef Acc Go To Pos After Actual Command (0B8xh)	47
4.3.101 VAI Predef Acc Go To Pos On Rising Trigger Event (0BAxh)	47
4.3.102 VAI Predef Acc Increment Target Pos On Rising Trigger Event (0BBxh)	47
4.3.103 VAI Predef Acc Go To Pos On Falling Trigger Event (0BCxh)	48
4.3.104 VAI Predef Acc Increment Target Pos On Falling Trigger Event (0BDxh)	48
4.3.105 VAI Dec=Acc Go To Pos (0C0xh)	48
4.3.106 VAI Dec=Acc Increment Dem Pos (0C1xh)	48
4.3.107 VAI Dec=Acc Increment Target Pos (0C2xh)	48
4.3.108 VAI Dec=Acc Go To Pos From Act Pos And Act Vel (0C3xh)	49
4.3.109 VAI Dec=Acc Go To Pos From Act Pos Starting With Dem Vel = 0 (0C4xh)	49
4.3.110 VAI Dec=Acc Go To Pos With Max Curr (0C5xh)	49
4.3.111 VAI Dec=Acc Go To Pos From Act Pos And Vel With Max Curr (0C6xh)	50
4.3.112 VAI Dec=Acc Go To Pos From Act Pos And Vel = 0 With Max Curr (0C7xh)	50
4.3.113 VAI Dec=Acc Go To Pos After Actual Command (0C8xh)	50
4.3.114 VAI Dec=Acc Go To Pos On Rising Trigger Event (0CAxh)	50
4.3.115 VAI Dec=Acc Increment Target Pos On Rising Trigger Event (0CBxh)	51
4.3.116 VAI Dec=Acc Go To Pos On Falling Trigger Event (0CCxh)	51
4.3.117 VAI Dec=Acc Increment Target Pos On Falling Trigger Event (0CDxh)	51
4.3.118 VAI Increment Captured Pos (0D0xh)	51
4.3.119 VAI 16 Bit Dec=Acc Go To Pos (0D1xh)	51
4.3.120 VAI Go To Cmd Tab Var1 Pos (0D4xh)	51
4.3.121 VAI Go To Cmd Tab Var2 Pos (0D5xh)	52
4.3.122 VAI Go To Cmd Tab Var1 Pos From Act Pos And Act Vel (0D6xh)	52
4.3.123 VAI Go To Cmd Tab Var2 Pos From Act Pos And Act Vel (0D7xh)	52
4.3.124 VAI Start Trig Rise Config VAI Command (0DExh)	53
4.3.125 VAI Start Trig Rise Config VAI Command (0DFxh)	53
4.3.126 Encoder Cam Enable (100xh)	53
4.3.127 Encoder Cam Disable (101xh)	53
4.3.128 Encoder Cam Go To Sync Pos (102xh)	53
4.3.129 Encoder Cam Set Value (104xh)	53
4.3.130 Encoder Cam y Define Curve With Default Parameters (1y0xh)	53
4.3.131 Encoder Cam y Define Curve From Act Pos (1y1xh)	54
4.3.132 Encoder Cam y Define Curve To Pos (1y2xh)	54
4.3.133 Encoder Cam y Define Curve From Pos To Pos In Counts (1y3xh)	54
4.3.134 Encoder Cam y Define Curve To Pos In Counts (1y4xh)	54
4.3.135 Encoder Cam y Define Curve With Amplitude Scale In Counts (1y5xh)	55
4.3.136 Encoder Cam y Enable (1y6xh)	55
4.3.137 Encoder Cam y Disable (1y7xh)	55
4.3.138 Encoder Cam y Change Amplitude Scale and Length (1y8xh)	55
4.3.139 Encoder Winding Start With Default Parameters (300xh)	55
4.3.140 Encoder Winding Start With Default Parameters At Revolutions (301xh)	55
4.3.141 Start Command Table Command (200xh)	56
4.3.142 Start Command Table Command On Rising Trigger Event (201xh)	56
4.3.143 Start Command Table Command On Falling Trigger Event (202xh)	56
4.3.144 Modify Command Table 16 bit Parameter in RAM (208xh)	56
4.3.145 Modify Command Table 32 bit Parameter in RAM (209xh)	56
4.3.146 Wait Time (210xh)	57
4.3.147 Wait Until Motion Finished (211xh)	57
4.3.148 Wait Until In Target Position (212xh)	57

<u>4.3.149 Wait Until Rising Trigger Event (213xh)</u>	<u>57</u>
<u>4.3.150 Wait Until Falling Trigger Event (214xh)</u>	<u>57</u>
<u>4.3.151 Wait Until Demand Position Greater Than (220xh)</u>	<u>57</u>
<u>4.3.152 Wait Until Demand Position Less Than (221xh)</u>	<u>57</u>
<u>4.3.153 Wait Until Actual Position Greater Than (222xh)</u>	<u>58</u>
<u>4.3.154 Wait Until Actual Position Less Than (223xh)</u>	<u>58</u>
<u>4.3.155 Wait Until Difference Position Greater Than (224xh)</u>	<u>58</u>
<u>4.3.156 Wait Until Difference Position Less Than (225xh)</u>	<u>58</u>
<u>4.3.157 Wait Until Difference Position Unsigned Greater Than (226xh)</u>	<u>58</u>
<u>4.3.158 Wait Until Difference Position Unsigned Less Than (227xh)</u>	<u>58</u>
<u>4.3.159 Wait Until Demand Velocity Greater Than (228xh)</u>	<u>59</u>
<u>4.3.160 Wait Until Demand Velocity Less Than (229xh)</u>	<u>59</u>
<u>4.3.161 Wait Until Actual Velocity Greater Than (22Axh)</u>	<u>59</u>
<u>4.3.162 Wait Until Actual Velocity Less Than (22Bxh)</u>	<u>59</u>
<u>4.3.163 Wait Until Current Greater Than (22Exh)</u>	<u>59</u>
<u>4.3.164 Wait Until Current Less Than (22Fhx)</u>	<u>59</u>
<u>4.3.165 Set Cmd Table Var 1 To (240xh)</u>	<u>60</u>
<u>4.3.166 Add To Cmd Table Var 1 (241xh)</u>	<u>60</u>
<u>4.3.167 Set Cmd Table Var 2 To (242xh)</u>	<u>60</u>
<u>4.3.168 Add To Cmd Table Var 2 (243xh)</u>	<u>60</u>
<u>4.3.169 Write Cmd Table Var 1 To UPID RAM value (248xh)</u>	<u>60</u>
<u>4.3.170 Write Cmd Table Var 2 To UPID RAM value (249xh)</u>	<u>60</u>
<u>4.3.171 Write UPID RAM Value To Cmd Table Var 1 (24Cxh)</u>	<u>60</u>
<u>4.3.172 Write UPID RAM Value To Cmd Table Var 2 (24Dxh)</u>	<u>60</u>
<u>4.3.173 IF Cmd Table Var 1 Less Than (250xh)</u>	<u>61</u>
<u>4.3.174 IF Cmd Table Var 1 Greater Than (251xh)</u>	<u>61</u>
<u>4.3.175 IF Cmd Table Var 1 Less Than (252xh)</u>	<u>61</u>
<u>4.3.176 IF Cmd Table Var 1 Greater Than (253xh)</u>	<u>61</u>
<u>4.3.177 IF Demand Position Less Than (258xh)</u>	<u>61</u>
<u>4.3.178 IF Demand Position Greater Than (259xh)</u>	<u>61</u>
<u>4.3.179 IF Actual Position Less Than (25Axh)</u>	<u>62</u>
<u>4.3.180 IF Actual Position Greater Than (25Bxh)</u>	<u>62</u>
<u>4.3.181 IF Difference Position Less Than (25Cxh)</u>	<u>62</u>
<u>4.3.182 IF Difference Position Greater Than (25Dxh)</u>	<u>62</u>
<u>4.3.183 IF Current Less Than (25Exh)</u>	<u>62</u>
<u>4.3.184 IF Current Greater Than (25Fhx)</u>	<u>62</u>
<u>4.3.185 IF Analog Val On X4.4 Less Than (260xh)</u>	<u>63</u>
<u>4.3.186 IF Masked X4 Input Value Equal Than (262xh)</u>	<u>63</u>
<u>4.3.187 IF Masked X6 Input Value Equal Than (263xh)</u>	<u>63</u>
<u>4.3.188 IF Masked Status Word Equal Than (264xh)</u>	<u>63</u>
<u>4.3.189 IF Masked Warn Word Equal Than (265xh)</u>	<u>63</u>
<u>4.3.190 Encoder Winding Stop Adaptation Of Left/Right Position and Disturbance (304xh)</u>	<u>63</u>
<u>4.3.191 Encoder Winding Restart Adaptation Of Left/Right Position and Disturbance (305xh)</u>	<u>64</u>
<u>4.3.192 Encoder Curve Winding Start With Default Parameters (310xh)</u>	<u>64</u>
<u>4.3.193 Encoder Curve Winding Start With Default Parameters At Revolutions (311xh)</u>	<u>64</u>
<u>4.3.194 VAI Go To Pos With Higher Force Ctrl Limit (380xh)</u>	<u>64</u>
<u>4.3.195 VAI Go To Pos From Act Pos And Reset Force Control (381xh)</u>	<u>64</u>

4.3.196 Force Ctrl Change Target Force (382xh)	65
4.3.197 VAI Go To Pos With Higher Force Ctrl Limit and Target Force (383xh)	65
4.3.198 VAI Go To Pos With Lower Force Ctrl Limit (384xh)	65
4.3.199 VAI Go To Pos With Lower Force Ctrl Limit and Target Force (385xh)	66
5 SETPOINT GENERATION	67
5.1 VA-INTERPOLATOR	67
5.1.1.1 Parameters and Output	67
5.2 P(V)-STREAM	68
5.3 CAM MOTIONS	69
5.3.1 Triggered Cam Motions	69
5.3.2 Repeated Cam Motions with the Modulo CamMode	69
5.4 WINDING	70
5.4.1 Winding disturbance	70
6 COMMAND TABLE	71
7 DRIVE CONFIGURATION	72
7.1 POWER BRIDGE	72
7.2 X4 I/O DEFINITIONS	72
7.2.1 X4.3 Brake	72
7.2.1.1 X4.3 Brake Operation Enabled Behavior	73
7.2.1.2 X4.3 Brake Operation /Abort Behavior	73
7.2.1.3 X4.3 Brake Operation Quick Stop Behavior	74
7.2.2 X4.6 Trigger	74
7.2.2.1 Direct Trigger Mode	74
7.2.2.2 Inhibited Trigger Mode	75
7.2.2.3 Delayed Trigger Mode	75
7.2.2.4 Inhibited & Delayed Trigger Mode	76
7.2.3 X4.8 and X4.9 Limit Switches	76
7.2.4 X4.10 and X4.11 PTC 1 and PTC 2	76
7.2.5 X4.12 SVE (Safety Voltage Enable)	77
7.3 MASTER ENCODER	77
7.4 MONITORING	79
7.4.1 Logic Supply Voltage	79
7.4.2 Motor Supply Voltage	79
7.4.2.1 Phase Switch On Test	79
7.4.3 Regeneration Resistor	80
7.4.4 Temperature Monitoring	81
7.5 PosCTRLSTRUCTURE	82
8 MOTOR CONFIGURATION	83
8.1 GENERIC MOTOR TEMPERATURE CALCULATED	83
9 STATE MACHINE SETUP	84
10 ERROR CODE LIST	85
11 CONTACT ADDRESSES	92

System Overview

This user Manual describes the Motion Control SW functionality of the LinMot E1100 / B1100 drives.

1.1 References

Ref	Title	Source
1	Installation_Guide_E1100.pdf	www.linmot.com
2	Installation_Guide_B1100.pdf	www.linmot.com
3	Usermanual_LinMot-Talk_4.pdf	www.linmot.com
4	QuickStartGuide_B1100-VF.pdf	www.linmot.com

The documentation is distributed with the LinMot-Talk configuration software or can be downloaded from the Internet from the download section of our homepage.

1.2 Definitions, Items, Shortcuts

Shortcut	Meaning
LM	LinMot linear motor
OS	Operating system (Software)
MC (SW)	Motion Control (Software)
Intf	Interface (Software)
Appl	Application (Software)
VAI	VA-Interpolator (Max velocity limited acceleration position interpolator)
Pos	Position
Vel	Velocity
Acc	Acceleration
Dec	Deceleration
UPID	Unique Parameter ID (16 bit)

1.3 Data types

Type	Range/Format	Num of bytes
Bool	Boolean, False/True	1/8
Byte	0..255	1
Char	ASCII	1
String	Array of char last char = 00h	X
SInt16	-32768..32767	2
UInt16	0..65535	2
SInt32	-2147483648..2147483647	4
UInt32	0..4294967295	4

2 Motion Control Interfaces

For controlling the behavior of the motion control SW, two different Interfaces are available. For controlling the main state machine, a bit coded **control word** can be used. For controlling the motion functionality a memory mapped **motion command interface** can be used. These two instances are mapped via an interface SW to an upper control system (PLC, IPC, PC, ..). The interfacing is done with digital I/Os or a serial link like Profibus DP, CAN bus (DeviceNet, CANopen), RS485, RS422 or RS232 (LinRS protocol).

With LinMot-Talk the control over the control word can be taken bit by bit, for testing and debugging. Unused control word bits can be forced by parameter value.

Also the control of the motion command interpreter can be switched to the control panel of the LinMot-Talk software for testing.

All this can be done while the system is running, so be careful using this features on a running machine!

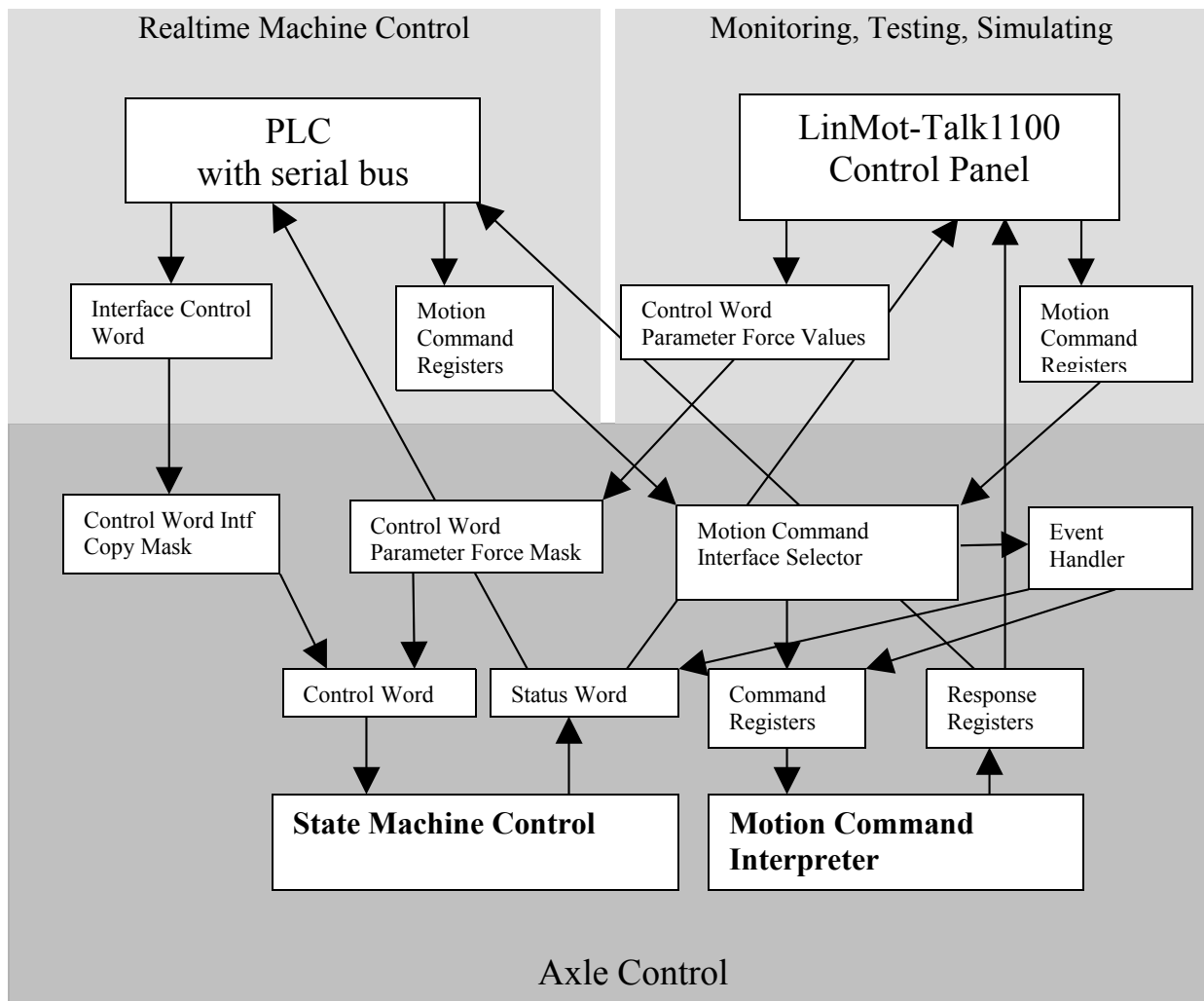

3 State Machine

The main behavior of the axes is controlled with the control word, it is shown in the following state diagram.

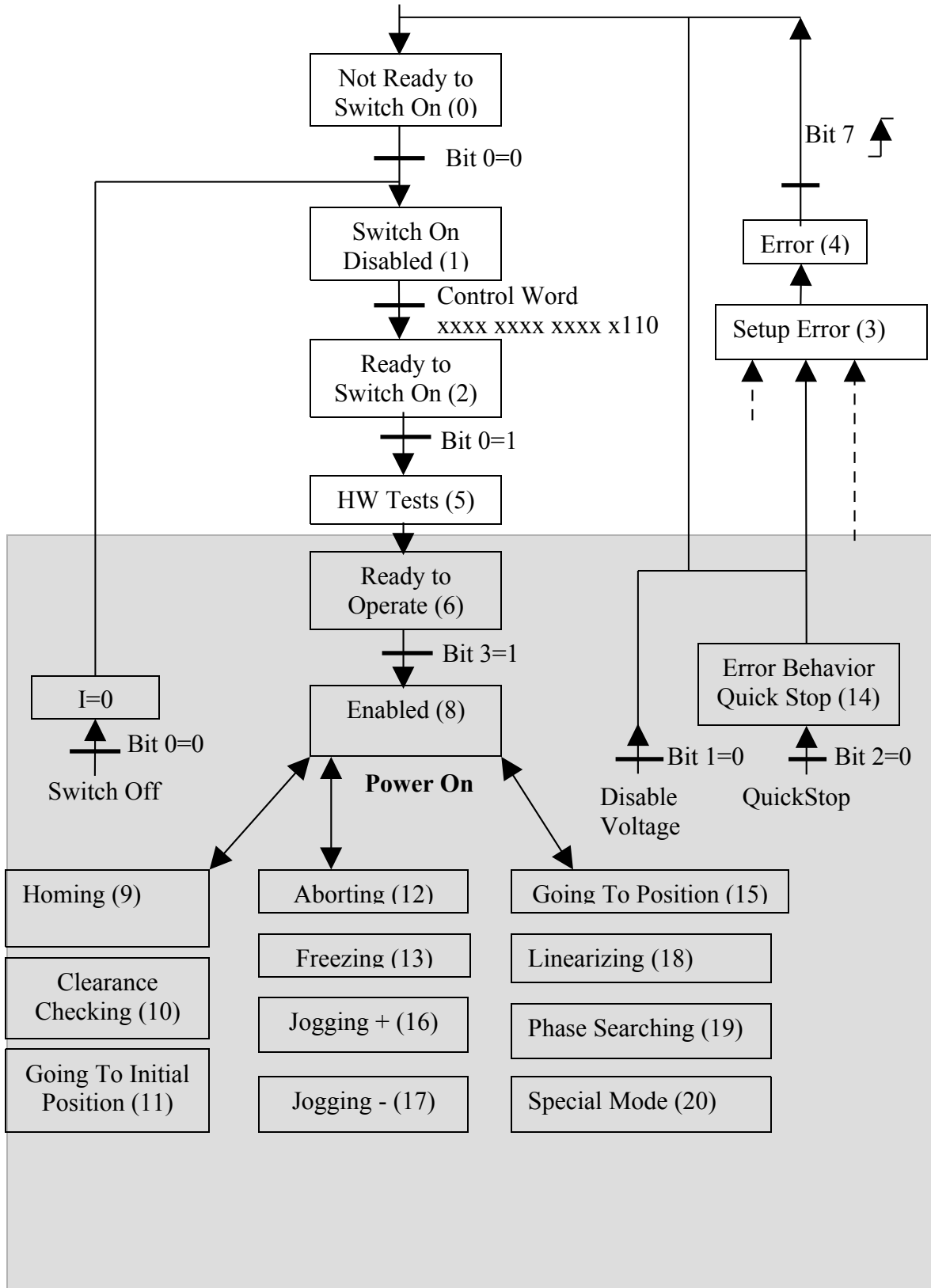

The state machine can be followed in the PLCs with fieldbus using the the StateVar. This response word can be configured for any supported fieldbus.

State Var															
Main State								Sub State							
15	14	13	12	11	10	9	8	7	6	5	4	3	2	1	0

The State Var is divided into two sections: the Main State section (high byte) contains directly the number of the state machine, the content of the Sub State (low byte) is state depending.

State Var	
Main State	Sub State
00: Not Ready To Switch On	0
01: Switch On Disabled	0
02: Ready To Switch On	0
03: Setup Error	Error Code which will be logged
04: Error	Logged Error Code
05: HW Tests	0 (Not yet defined)
06: Ready To Operate	0 (Not yet defined)
07: -	
08: Operation Enabled	Bits 0..3: Motion Command Count Bit 4: Event Handler Active Bit 5: Motion Active Bit 6: In Target Position Bit 7: Homed
09: Homing	0Fh: Homing Finished
10: Clearance Check	0Fh: Clearance Check Finished
11: Going To Initial Position	0Fh: Going To Initial Position Finished
12: Aborting	Not yet defined
13: Freezing	Not yet defined
14: Quick Stop (Error Behaviour)	Not yet defined
15: Going To Position	0Fh: Going To Position Finished
16: Jogging +	01h: Moving positive 0Fh: Jogging +Finished
17: Jogging -	01h: Moving negative 0Fh: Jogging -Finished
18: Linearizing	Not yet defined
19: Phase Search	Not yet defined
20: Special Mode	Not yet defined

3.1 State 0: Not Ready To Switch On

In this state the release of control word bit 0 *switch on* is awaited. As soon as this bit is cleared a change to state 1 is performed. This behavior avoids self starting if all necessary bits for a start are set correctly in the control word.

3.2 State 1: Switch On Disabled

The state machine rests in this state as long as the bits 1 or 2 of the control word are cleared.

3.3 State 2: Ready To Switch On

The state machine rests in this state as long as the bit 0 is cleared.

3.4 State 3: Setup Error State

The state machine rests in this state as long the bits 0 is cleared.

3.5 State 4: Error State

The error state can be acknowledged with a rising edge of the control word bit 7 'Error Acknowledge'. If the error is fatal, bit 12 'Fatal Error' in the status word is set, no error acknowledgment is possible.

In the case of a fatal error, the error has to be checked, and the problem has to be solved before a reset or power cycle is done for resetting the error.

3.6 State 5: HW Test

The HW Test state is an intermediate state before turning on the power stage of the drive. If everything seems to be ok the drive changes to state 6 without any user action. The test takes about 300ms.

3.7 State 6: Ready to Operate

In this state the motor is either position controlled or with demand current = 0 and under voltage, but no motion commands are accepted. The mode is configurable with UPID 6300h.

Sending motion commands in this state will generate the error 'Motion command sent in wrong state' and a state change to the error state will be performed.

Clearing the control word bit 3 'Enable Operation' in state 8 or higher will stop immediately the set point generation and a state transition to 6 is performed. Clearing the bit while a motion is in execution a following error might be generated.

3.8 State 8: Operation Enabled

This is the state of the normal operation in which the motion commands are executed. It is strongly recommended to use the State Var for the motion command synchronization with any fieldbus system.

State Var															
Main State = 8								Homed	Position In Target	Motion Active	Event Handler	Motion Command Count			
15	14	13	12	11	10	9	8	7	6	5	4	3	2	1	0

In the high byte stands the number of the main state = 8. In the low byte stands in the lowest 4 bits the actual interpreted 'Motion Command Count', bit 4 indicates if the event handler is active, in bit 5 stands the status word bit 'Motion Active', in bit 6 the status word bit 'In Target Position' and in bit 7 the status word bit 'Homed'. Because the 'Motion Command Count' echo and this status word bits are located in the same byte no data consistency problem is possible with any fieldbus.

A new motion command can be setup when the Motion Command Count has changed to the last sent **and** the 'Motion Active' bit is 0 or the 'In Target Position' bit is 1 if an exact positioning is required.

3.9 State 9: Homing

The homing state is used to define the position of the system according a mechanical reference, a home switch or an index.

For LinMot motors the slider home position at this home position is taken to compensate edge effects.

In the home sequence a position check of two positions and the motion to an initial position can be added.

Hint: If a mechanical stop homing mode is chosen, the initial position should be a little apart from this mechanical stop to avoid overheating of the motor.

3.10 State 10: Clearance Check

Setting the Clearance Check bit in the Control Word, two positions are moved to, to check if the whole motion range is free. Normally this action is added to the homing sequence to ensure that the homing was done correctly.

3.11 State 11: Going To Initial Position

Setting the Go To Initial Position bit in the control word, the motor moves to the initial position, normally used to move away from the mechanical stop after homing, to protect the motor from overheating at the mechanical stop. After an error it is also recommended to move to a defined position again.

3.12 State 12: Aborting

Clearing the /Abort bit in the control word initiates a quick stop. After the motion has stopped the drive rests position controlled. Setting the bit again the drive rests in position until a new motion command is executed.

3.13 State 13: Freezing

Clearing the /Freeze bit in the control word initiates a quick stop. After the motion is stopped the drive rests position controlled. Setting the bit again the drive will finish the frozen motion (e.g. if it was a VAI command). Curve motion can be frozen but not restarted by releasing this bit, setting the bit again the motor moves at the target position of the last VAI command, if never used a VAI command it will go to the initial position.

3.14 State 14: Error Behaviour Quick Stop

Most of the errors, which can occur during an active motion, cause a quick stop behavior to stop the motion. After the quick stop is finished the motor is no longer position controlled.

3.15 State 15: Going To Position

Setting the Go To Position bit in the control word, the servo moves to the defined position, recommendable for example, after an error, to move to a defined position again.

3.16 State 16: Jogging +

Setting the Jog Move + bit in the control word, the motor moves either by a defined position increment or to the maximal position with a limited speed. Releasing the bit will stop the motion.

3.17 State 17: Jogging -

Setting the Jog Move - bit in the control word, the motor moves either a defined position decrement or to the minimal position with a limited speed. Releasing the bit will stop the motion

3.18 State 18: Linearizing

The linearizing state is used to correct position feedback parameters, to improve the linearity of the position feedback.

3.19 State 19: Phase Searching

The phase search is only defined for three phase EC motors with hall switches and ABZ-sensors to find the commutation offset for to the sensor. It cannot be guaranteed that this feature will work for all kinds of EC motors. The found offset can be found in the variable section Calculated Commutation Offset (UPID: 1C1Bh), and has to be set manually to the parameter Phase Angle (UPID 11F2h).

3.20 State 20: Special Mode

The Special Mode is available only on the B1100 drives. In this state the current command mode over the analog input is available. For using this mode see the [4].

3.21 Building the Control Word

The Control Word can be accessed bit by bit from different sources with different priorities. The highest priorities have the bits that are forced by parameters. The second highest priority has the control panel of the LinMot-Talk software, if logged in with the SW. The next lower priorities have the bits that are defined on the X4 IOs as control word input bits. The lowest priority have bits which are set over the interface (normally a serial fieldbus connection), so in the Ctrl Word Interface Copy mask all bits can be selected, without causing any problems, but bits which should not be accessed through the interface can be masked out.

3.22 Control Word

With the Control Word (16Bit) the main state machine of the drive can be accessed. Following table shows the meaning of each bit:

Bit Name	Val	Meaning	Remark
0 Switch On	0	OFF1	A-Stop, -> Current = 0, power switches disabled
	1	ON	State change from switch on disabled to ready to switch on
1 Voltage Enable	0	OFF2	Power switches disabled without microcontroller action
	1	Operation	
2 /Quick Stop	0	OFF3	Quick Stop -> Current = 0 -> H-Bridges disabled
	1	Operation	
3 Enable Operation	0	Operation disabled	Position controller active Motion Commands disabled
	1	Operation enable	Position controller active Motion Commands enabled
4 /Abort	0	Abort	Quick Stop position control rests active, motion command is cleared.
	1	Operation	
5 /Freeze	0	Freeze motion	Quick Stop position control rests active, Target position not cleared, curves motions are aborted
	1	Operation	Rising edge will reactivate motion command
6 Go To Position	0		
	1	Go To Position	Go to fixed parameterized Position. Wait for release of signal.
7 Error Acknowledge	0		
	1	Error Acknowledge	Rising edge of signal acknowledges error
8 Jog Move +	0		
	1		Jog Move +
9 Jog Move -	0		
	1		Jog Move -
10 Special Mode	0		
	1	Special Mode	Special Mode
11 Home	0	Stop Homing	
	1	Homing	At startup bit 11 Status word is cleared, until procedure is finished.
12 Clearance Check	0	Stop Clearance Check	
	1	Clearance Check	Enable Clearance Check Movements
13 Go To Initial Position	0		
	1	Go To initial Position	Rising edge will start go to initial position
14 Reserved	0		
	1		Reserved
15 Phase Search	0	Stop Phase Search	
	1	Phase Search	Enable Phase Search Movements

3.23 Status Word

Following table shows the meaning of the single bits:–

Bit Name	Val	Meaning	Remark
0 Operation Enabled	0		State Nr < 8
	1	Operation Enabled	State Nr 8 or higher (copied to drive EN LED)
1 Switch On Active	0	Switch On Disabled	Control Word Bit 0
	1	Switch On Enabled	
2 Enable Operation	0	Operation Disabled	Control Word Bit 3
	1	Operation	
3 Error	0	No Error	Acknowledge with Control word Bit 7 (Reset Error)
	1	Error	
4 Voltage Enable	0	Power Bridge Off	Control Word Bit 1
	1	Operation	
5 /Quick Stop	0	Active	Control Word Bit 2
	1	Operation	
6 Switch On Locked	0	Not Locked	Release with 0 of Control word bit 0 (Switch On)
	1	Switch On Locked	
7 Warning	0	Warning not active	No bit is set in the Warn Word
	1	Warning active	One or more bits in the Warn Word are set
8 Event Handler Active	0	Event Handler Inactive	Event Handler cleared or disabled
	1	Event Handler Active	Event Handler setup
9 Special Motion Active	0	Normal Operation	Special motion commands (Homing, ..) runs
	1	Special Command runs	
10 In Target Position	0	Not In Pos	Motion active or actual position out of window
	1	In Pos	Actual position after motion in window
11 Homed	0	Motor not homed	Incremental sensor not homed (referenced)
	1	Motor homed	Position sensor system valid
12 Fatal Error	0		A fatal error cannot be acknowledged!
	1	Fatal Error	
13 Motion Active	0	No Motion	Setpoint generation inactive
	1	Motion active	Setpoint generation (VAI, curve) active
14 Range Indicator 1	0	Not In Range 1	Defined UPID is not in Range 1
	1	In Range1	Defined UPID is in Range 1
15 Range Indicator 2	0	Not In Range 2	Defined UPID is not in Range 2
	1	In Range2	Defined UPID is in Range 2

3.24 Warn Word

Following table shows the meaning of the single bits of the Warn Word:

Bit Name	Val	Meaning
0 Motor Hot Sensor	0	Normal Operation
	1	Motor Temperature Sensor On
1 Motor Short Time Overload I ² t	0	Normal Operation
	1	Calculated Motor Temperature Reached Warn Limit
2 Motor Supply Voltage Low	0	Normal Operation
	1	Motor Supply Voltage Reached Low Warn Limit
3 Motor Supply Voltage High	0	Normal Operation
	1	Motor Supply Voltage Reached High Warn Limit
4 Position Lag Always	0	Normal Operation
	1	Position Error during Moving Reached Warn Limit
5 Position Lag Standing (not on B1100)	0	Normal Operation
	1	Position Error During Standing Reached Warn Limit
6 Drive Hot	0	Normal Operation
	1	Temperature on Drive High
7 Motor Not Homed	0	Normal Operation
	1	Warning Motor Not Homed Yet
8 PTC Sensor 1 Hot	0	Normal Operation
	1	PTC Temperature Sensor 1 On
9 Reserved PTC 2	0	Normal Operation
	1	PTC Temperature Sensor 2 On
10 RR Hot Calculated	0	Normal Operation
	1	Regenerative Resistor Temperature Hot Calculated
11 Reserved	0	
	1	
12 Reserved	0	
	1	
13 Reserved	0	
	1	
14 Interface Warn Flag	0	Normal Operation
	1	Warn Flag Of Interface SW layer
15 Application Warn Flag	0	Normal Operation
	1	Warn Flag Of Application SW layer

Normally the warn word bits are used to react in conditions before the drive goes into the error state. E.g. a typical reaction on the warning '*Motor Temperature Sensor*' would be a stop of the machine, before the drive goes into the error state and the motor goes out of control to avoid crashes.

4 Motion Command Interface

4.1 Motion Command Interface

The motion command interface consists of one word that contains the command ID, and up to 16 command parameter words. Example: 'VA-Interpolator 16 bit Go To Absolute Position'

Word	Description	Example of command
1.	Command Header with ID	Go To Absolute Position Immediate
2.	1. Command Parameter	Position
3.	2. Command Parameter	Maximal Speed
4.	3. Command Parameter	Acceleration
5.	4. Command Parameter	Deceleration
6.-16.	5. - Command Parameter	Not used

4.1.1 Command Header

Master ID								Sub ID				Command Count			
15	14	13	12	11	10	9	8	7	6	5	4	3	2	1	0

The header of the Motion command is split into three parts:

- Master ID
- Sub ID
- Command Count

4.1.1.1 Master ID

The master ID specifies the command group.

4.1.1.2 Sub ID

The sub ID is used to identify different commands from the same command group.

4.1.1.3 Command Count

A new command will only be executed, if the value of the command count has changed. In the easiest way bit 0 can be toggled.

4.2 Overview Motion Commands

Master ID	Sub ID	E	B	Description
		1	1	
		1	1	
		0	0	
		0	0	
00h	0h	X	X	No Operation
	1h	X	X	Write Interface Control Word
	2h	X	X	Write Live Parameter
	3h	X	X	Write X4/X14 Intf Outputs with Mask
	4h	X		Write X6 Intf Outputs with Mask
	8h	X	X	Clear Event Evaluation
	9h	X	X	Master Homing
01h	0h	X	X	VAI Go To Pos
	1h	X	X	VAI Increment Dem Pos
	2h	X	X	VAI Increment Target Pos
	3h	X	X	VAI Go To Pos From Act Pos And Act Vel
	4h	X	X	VAI Go To Pos From Act Pos Starting With Dem Vel = 0
	5h	X	X	VAI Increment Act Pos
	6h	X	X	VAI Increment Act Pos Starting with Dem Vel = 0
	7h	X	X	VAI Stop
	8h	X	X	VAI Go To Pos After Actual Command
	9h	X	X	VAI Go To Analog Pos
	Ah	X	X	VAI Go To Pos On Rising Trigger Event
	Bh	X	X	VAI Increment Target Pos On Rising Trigger Event
	Ch	X	X	VAI Go To Pos On Falling Trigger Event
	Dh	X	X	VAI Increment Target Pos On Falling Trigger Event
	Eh	X	X	VAI Change Motion Parameters On Positive Position Transition
	Fh	X	X	VAI Change Motion Parameters On Negative Position Transition
	02h	0h	X	X
1h		X	X	Predef VAI Increment Dem Pos
2h		X	X	Predef VAI Increment Target Pos
3h		X	X	Predef VAI Go To Pos From Act Pos And Act Vel
4h		X	X	Predef VAI Go To Pos From Act Pos Starting With Dem Vel = 0
7h		X	X	Predef VAI Stop With Quick Stop Deceleration
8h		X	X	Predef VAI Go To Pos After Actual Command
Ah		X	X	Predef VAI Go To Pos On Rising Trigger Event
Bh		X	X	Predef VAI Increment Target Pos On Rising Trigger Event
Ch		X	X	Predef VAI Go To Pos On Falling Trigger Event
Dh		X	X	Predef VAI Increment Target Pos On Falling Trigger Event
Eh		X	X	Predef VAI Infinite Motion Positive Direction
Fh		X	X	Predef VAI Infinite Motion Negative Direction
03h		0h	X	X
	1h	X	X	PV Stream With Slave Generated Time Stamp
	2h	X	X	P Stream With Slave Generated Time Stamp and Configured Period Time
	Fh	X	X	Stop Streaming
	04h	0h	X	k
1h		X	k	Time Curve With Default Parameters From Act Pos
2h		X	k	Time Curve To Pos With Default Speed
3h		X	k	Time Curve To Pos With Adjustable Time
4h		X	k	Time Curve With Adjustable Offset, Time Scale & Amplitude Scale

	5h	X	k	Time Curve With Adjustable Offset, Time & Amplitude Scale
	6h	X	k	Time Curve With Adjustable Offset, Time & Amplitude Scale On Rising Trigger Event
	7h	X	k	Time Curve With Adjustable Offset, Time & Amplitude Scale On Falling Trigger Event
	Ah	X	k	Time Curve To Pos With Default Speed On Rising Trigger Event
	Ch	X	k	Time Curve To Pos With Default Speed On Falling Trigger Event
	Eh	X	k	Time Curve To Pos With Adjustable Time On Rising Trigger Event
	Fh	X	k	Time Curve To Pos With Adjustable Time On Falling Trigger Event
05h	0h	X		Modify Curve Start Address in RAM
	1h	X		Modify Curve Info Block 16 Bit Value in RAM
	2h	X		Modify Curve Info block 32 Bit Value in RAM
	4h	X		Modify Curve Data Block 32 Bit in RAM
	5h	X		Modify Curve Data Block 64 Bit in RAM
	6h	X		Modify Curve Data Block 96 Bit in RAM
06h	4h	X	k	Setup Encoder CAM from Actual Counts With Delay Counts
	9h	X	k	Setup Encoder CAM On Rise Trigger Event With Delay Counts
	Ah	X	k	Setup Encoder CANM On Rise Trigger Event With Delay Counts, Target Pos and Length
	Bh	X	k	Setup Encoder CAM On Fall Trigger Event With Delay Counts
	Ch	X	k	Setup Encoder CAM On Fall Trigger Event With Delay Counts, Target Pos and Length
	Dh	X	k	Setup Encoder CAM On Rise Trigger Event With Delay Counts Amplitude scale and length
	Eh	X	k	Setup Encoder CAM On Fall Trigger Event With Delay Counts Amplitude scale and length
07h	0h	X	X	Start VAI Encoder Position Indexing
	1h	X	X	Start Predef VAI Encoder Position Indexing
	Eh	X	X	Stop Position Indexing And VAI Go To Pos
	Fh	X	X	Stop Position Indexing And Predefined VAI Go To Pos
09h	0h	X	X	VAI 16 Bit Go To Pos
	1h	X	X	VAI 16 Bit Increment Dem Pos
	2h	X	X	VAI 16 Bit Increment Target Pos
	3h	X	X	VAI 16 Bit Go To Pos From Act Pos And Act Vel
	4h	X	X	VAI 16 Bit Go To Pos From Act Pos Starting With Dem Vel = 0
	5h	X	X	VAI 16Bit Increment Act Pos
	6h	X	X	VAI Increment Act Pos Starting with Dem Vel = 0
	7h	X	X	VAI 16 Bit Stop
	8h	X	X	VAI 16 Bit Go To Pos After Actual Command
	Ah	X	X	VAI 16 Bit Go To Pos On Rising Trigger Event
	Bh	X	X	VAI 16 Bit Increment Target Pos On Rising Trigger Event
	Ch	X	X	VAI 16 Bit Go To Pos On Falling Trigger Event
	Dh	X	X	VAI 16 Bit Increment Target Pos On Falling Trigger Event
	Eh	X	X	VAI 16 Bit Change Motion Parameters On Positive Position Transition
	Fh	X	X	VAI 16 Bit Change Motion Parameters On Negative Position Transition
	0Ah	0h	X	X
1h		X	X	Predef VAI 16 Bit Increment Dem Pos
2h		X	X	Predef VAI 16 Bit Increment Target Pos
3h		X	X	Predef VAI 16 Bit Go To Pos From Act Pos And Act Vel
4h		X	X	Predef VAI 16 Bit Go To Pos From Act Pos Starting With Dem Vel = 0

	7h	X	X	Predef VAI 16 Bit Stop With Quick Stop Deceleration
	8h	X	X	Predef VAI 16 Bit Go To Pos After Actual Command
	Ah	X	X	Predef VAI 16 Bit Go To Pos On Rising Trigger Event
	Bh	X	X	Predef VAI 16 Bit Increment Target Pos On Rising Trigger Event
	Ch	X	X	Predef VAI 16 Bit Go To Pos On Falling Trigger Event
	Dh	X	X	Predef VAI 16 Bit Increment Target Pos On Falling Trigger Event
0Bh	0h	X		VAI Predef Acc Go To Pos
	1h	X		VAI Predef Acc Increment Dem Pos
	2h	X		VAI Predef Acc Increment Target Pos
	3h	X		VAI Predef Acc Go To Pos From Act Pos And Act Vel
	4h	X		VAI Predef Acc Go To Pos From Act Pos Starting With Dem Vel = 0
	8h	X		VAI Predef Acc Go To Pos After Actual Command
	Ah	X		VAI Predef Acc Go To Pos On Rising Trigger Event
	Bh	X		VAI Predef Acc Increment Target Pos On Rising Trigger Event
	Ch	X		VAI Predef Acc Go To Pos On Falling Trigger Event
	Dh	X		VAI Predef Acc Increment Target Pos On Falling Trigger Event
0Ch	0h	X	X	VAI Dec=Acc Go To Pos
	1h	X	X	VAI Dec=Acc Increment Dem Pos
	2h	X	X	VAI Dec=Acc Increment Target Pos
	3h	X	X	VAI Dec=Acc Go To Pos From Act Pos And Act Vel
	4h	X	X	VAI Dec=Acc Go To Pos From Act Pos Starting With Dem Vel = 0
	5h	X	X	VAI Dec=Acc Go To Pos With Max Curr
	6h	X	X	VAI Dec=Acc Go To Pos From Act Pos And Act Vel With Max Curr
	7h	X	X	VAI Dec=Acc Go To Pos From Act Pos, Dem Vel = 0 and With Max Curr
	8h	X	X	VAI Dec=Acc Go To Pos After Actual Command
	Ah	X	X	VAI Dec=Acc Go To Pos On Rising Trigger Event
	Bh	X	X	VAI Dec=Acc Increment Target Pos On Rising Trigger Event
	Ch	X	X	VAI Dec=Acc Go To Pos On Falling Trigger Event
	Dh	X	X	VAI Dec=Acc Increment Target Pos On Falling Trigger Event
	Eh	X	X	VAI Dec=Acc Infinite Motion Positive Direction
	Fh	X	X	VAI Dec=Acc Infinite Motion Negative Direction
	0Dh	0h	X	X
1h		X	X	VAI Dec=Acc 16 Bit Go To Pos
4h		X	X	VAI Go To Cmd Table Var 1 Pos
5h		X	X	VAI Go To Cmd Table Var 2 Pos
6h		X	X	VAI Go To Cmd Table Var 1 Pos From Act Pos And Act Vel
7h		X	X	VAI Go To Cmd Table Var 2 Pos From Act Pos And Act Vel
Eh		X	X	VAI Start Trig Rise Config VAI Command
Fh		X	X	VAI Start Trig Rise Config VAI Command
10h		0h	X	k
	1h	X	k	Encoder CAM Disable
	2h	X	k	Encoder CAM Go To Sync Pos
	4h	X	k	Encoder CAM Set Value
11h	0h	X	k	Encoder CAM 1 Define Curve With Default Parameters
	1h	X	k	Encoder CAM 1 Define Curve From Act Pos
	2h	X	k	Encoder CAM 1 Define Curve To Pos
	3h	X	k	Encoder CAM 1 Define Curve From Pos To Pos In Counts
	4h	X	k	Encoder CAM 1 Define Curve To Pos In Counts
	5h	X	k	Encoder CAM 1 Define Curve with Amplitude Scale In Counts
	6h	X	k	Encoder CAM 1 Enable
	7h	X	k	Encoder CAM 1 Disable

	8h	X	k	Encoder CAM 1 Change Amplitude Scale and Length
12h	0h	X	k	Encoder CAM 2 Define Curve With Default Parameters
	1h	X	k	Encoder CAM 2 Define Curve From Act Pos
	2h	X	k	Encoder CAM 2 Define Curve To Pos
	3h	X	k	Encoder CAM 2 Define Curve From Pos To Pos In Counts
	4h	X	k	Encoder CAM 2 Define Curve To Pos In Counts
	5h	X	k	Encoder CAM 2 Define Curve with Amplitude Scale In Counts
	6h	X	k	Encoder CAM 2 Enable
	7h	X	k	Encoder CAM 2 Disable
	8h	X	k	Encoder CAM 2 Change Amplitude Scale and Length
20h	0h	X	X	Start Command Table Command
	1h	X	X	Start Command Table Command On Rising Trigger Event
	2h	X	X	Start Command Table Command On Falling Trigger Event
	8h	X		Modify Command Table 16 bit Parameter in RAM
	9h	X		Modify Command Table 32 bit Parameter in RAM
21h	0h	X	X	Wait Time
	1h	X	X	Wait Until Motion Finished
	2h	X	X	Wait Until In Target Position
	3h	X	X	Wait Until Rising Trigger Edge
	4h	X	X	Wait Until Falling Trigger Edge
	8h	X	X	Wait Time Defined With Cmd Table Var 1
	9h	X	X	Wait Time Defined With Cmd Table Var 2
22h	0h	X	X	Wait Until Demand Position Greater Than
	1h	X	X	Wait Until Demand Position Less Than
	2h	X	X	Wait Until Actual Position Greater Than
	3h	X	X	Wait Until Actual Position Less Than
	4h	X	X	Wait Until Difference Position Greater Than
	5h	X	X	Wait Until Difference Position Less Than
	6h	X	X	Wait Until Difference Position Unsigned Greater Than
	7h	X	X	Wait Until Difference Position Unsigned Less Than
	8h	X	X	Wait Until Demand Velocity Greater Than
	9h	X	X	Wait Until Demand Velocity Less Than
	Ah	X	X	Wait Until Actual Velocity Greater Than
	Bh	X	X	Wait Until Actual Velocity Less Than
	Eh	X	X	Wait Until Current Greater Than
	Fh	X	X	Wait Until Current Less Than
	24h	0h	X	X
1h		X	X	Add To Cmd Table Var 1
2h		X	X	Set Cmd Table Var 2 To
3h		X	X	Add To Cmd Table Var 2
8h		X	X	Write Cmd Table Var 1 To UPID RAM value
9h		X	X	Write Cmd Table Var 2 To UPID RAM value
Ch		X	X	Write UPID RAM value To Cmd Table Var 1
Dh		X	X	Write UPID RAM value To Cmd Table Var 2
24h		Eh	X	X
25h	0h	X	X	IF Cmd Table Var 1 Less Than
	1h	X	X	IF Cmd Table Var 1 Greater Than
	2h	X	X	IF Cmd Table Var 2 Less Than
	3h	X	X	IF Cmd Table Var 2 Greater Than
	6h	X	X	IF Cmd Table Var 1 Less Than UPID Value
	7h	X	X	IF Cmd Table Var 2 Less Than UPID Value
	8h	X	X	IF Demand Position Less Than
	9h	X	X	IF Demand Greater Than

	Ah	X	X	IF Actual Position Less Than
	Bh	X	X	IF Actual Greater Than
	Ch	X	X	IF Difference Position Less Than
	Dh	X	X	IF Difference Greater Than
	Eh	X	X	IF Current Less Than
	Fh	X	X	IF Current Greater Than
26h	0h	X	X	IF Analog Val On X4.4 Less Than
	2h	X	X	IF Masked X4 Input Value Equal Than
	3h	X		IF Masked X6 input Value Equal Than
	4h	X	X	IF Masked Status Word Equal Than
	5h	X	X	IF Masked Warn Word Equal Than
30h	0h	X	X	Encoder Winding Start With Default Parameters
	1h	X	X	Encoder Winding Start With Default Parameters At Revolutions
	4h	X	X	Encoder Winding Stop Adaptation Of Left, Right Position And Disturbance
	5h	X	X	Encoder Winding Restart Adaptation Of Left, Right Position And Disturbance
31h	0h	X	k	Encoder Curve Winding Start With Default Parameters
	1h	X	k	Encoder Curve Winding Start With Default Parameters At Revolutions
38h	0h	f	f	VAI Go To Pos With Force Ctrl Limit
	1h	f	f	VAI Go To Pos From Act Pos And Reset Force Control
	2h	f	f	Force Ctrl Change Target Force
	3h	f	f	VAI Go To Pos With Force Ctrl Limit and Target Force
	4h	f	f	VAI Go To Pos With Lower Force Ctrl Limit
	5h	f	f	VAI Go To Pos With Lower Force Ctrl Limit and Target Force

k: only with Curve key available (B1100)

f: only with Force Control Key

4.3 Detailed Motion Command Description

4.3.1 No Operation (000xh)

Name	Byte Offset	Description	Type	Unit
Header	0	No Operation (000xh)	UInt16	-

This command does nothing. It can be sent in any operational state.

4.3.2 Write Interface Control Word (001xh)

Name	Byte Offset	Description	Type	Unit
Header	0	001xh: Write Interface Control Word	UInt16	-
1. Par	2	Interface Control Word	UInt16	-

This command allows writing the control word through the motion command interface. The fieldbus interfaces (CANOpen, DeviceNet, Profibus, LinRS, POWERLINK, EtherCAT) offer other ways to access the control word directly. Mostly a direct access is more comfortable than the way over the motion command interface.

4.3.3 Write Live Parameter (002xh)

Name	Byte Offset	Description	Type	Unit
Header	0	002xh: Write Live Parameter	UInt16	-
1. Par	2	UPID (Unique Parameter ID)	UInt16	-
2. Par	4	Parameter Value, the Unit depends on Parameter	Div	Div

This command allows writing any live parameter's ram value through the motion command interface. The parameter has to be specified by its UPID (Unique Parameter ID). In order to keep the interface as simple as possible any parameter can be accessed as 32bit integer value. The drive's operating system will filter out the relevant number of bits for parameters with smaller data size (e.g. only the lowest bit is considered for Boolean parameters). The fieldbus interfaces (CANOpen, DeviceNet, Profibus, LinRS, POWERLINK, EtherCAT) offer other ways to read and write parameter values directly. Mostly a direct access is more comfortable than the way over the motion command interface.

4.3.4 Write X4 Intf Outputs with Mask (003xh)

Name	Byte Offset	Description	Type	Unit
Header	0	003xh: Write X4 Intf Outputs with Mask	UInt16	-
1. Par	2	Bit Mask; Bit 0 = X4.3 Bit 1 = X4.4...	UInt16	-
2. Par	4	Bit Value; Bit 0 = X4.3, Bit 1 X4.4...	UInt16	-

This command allows writing the configured X4 interface outputs with a write mask through the motion command interface. To write an output, the corresponding bit in the mask must be set. Bit 0 is mapped to output X4.3, bit 1 to output X4.4 etc.

4.3.5 Write X6 Intf Outputs with Mask (004xh)

Name	Byte	Description	Type	Unit
------	------	-------------	------	------

	Offset			
Header	0	004xh: Write X6 Intf Outputs with Mask	UInt16	-
1. Par	2	Bit Mask; Bit 0 = X6.9 Bit 1 = X6.22...	UInt16	-
2. Par	4	Bit Values; Bit 0 = X6.9, Bit 1 X6.22, ...	UInt16	-

This command allows writing the X6 interface outputs with a write mask through the motion command interface. To write an output, the corresponding bit in the mask must be set. Bit 0 is mapped to output X6.9, bit 1 to output X6.22 etc.

4.3.6 Clear Event Evaluation (008xh)

Name	Byte Offset	Description	Type	Unit
Header	0	008xh: Clear Event Evaluation	UInt16	-

This command resets the event handler. The event handler becomes active, if a motion command has been sent, that does not immediately start, but waits with its execution until other conditions are fulfilled (e.g. command 'VAI Go To Pos On Rising Trigger Event'). The bit 8 of the status word shows, if the event handler is active.

Once the event handler becomes active, it remains active, until it is deactivated with this clear command. As long the event handler is active, the command to be executed on the event situation will be restarted each time the event condition is fulfilled.

4.3.7 Master Homing (009xh)

Name	Byte Offset	Description	Type	Unit
Header	0	009xh: Master Homing	UInt16	-
1. Par	2	Home Position	SInt32	0.1 um

This command can be used, if the master system knows the home position without going to the home state in the state machine. The passed value of the home position is stored in the RAM value of the parameter Home Position (UPID 13C7h), then the corresponding value of the parameter Slider Home Position (UPID 13CAh) is calculated and stored in the RAM value. Then a homing at actual position is done without going into the homing state.

4.3.8 VAI Go To Pos (010xh)

Name	Byte Offset	Description	Type	Unit
Header	0	010xh: VAI Go To Pos	UInt16	-
1. Par	2	Target Position	SInt32	0.1 um
2. Par	6	Maximal Velocity	UInt32	1E-6 m/s
3. Par	10	Acceleration	UInt32	1E-5 m/s ²
4. Par	14	Deceleration	UInt32	1E-5 m/s ²

4.3.9 VAI Increment Dem Pos (011xh)

Name	Byte Offset	Description	Type	Unit
Header	0	011xh:VAI Increment Dem Pos	UInt16	-
1. Par	2	Position Increment	SInt32	0.1 μm
2. Par	6	Maximal Velocity	UInt32	1E-6 m/s
3. Par	10	Acceleration	UInt32	1E-5 m/s ²
4. Par	14	Deceleration	UInt32	1E-5 m/s ²

This command sets a new target position and defines the maximal velocity, acceleration and deceleration for going there. The new target position value will be determined by the firmware. It is calculated by adding the position increment argument to the demand position value. The demand position is the actual position setpoint on which the motor is controlled. The demand position value moves towards the target position value while a motion command is in execution.

4.3.10 VAI Increment Target Pos (012xh)

Name	Byte Offset	Description	Type	Unit
Header	0	012xh: VAI Increment Target Pos	UInt16	-
1. Par	2	Position Increment	SInt32	0.1 μm
2. Par	6	Maximal Velocity	UInt32	1E-6 m/s
3. Par	10	Acceleration	UInt32	1E-5 m/s ²
4. Par	14	Deceleration	UInt32	1E-5 m/s ²

This command sets a new target position and defines the maximal velocity, acceleration and deceleration for going there. The new target position value will be determined by the firmware. It is calculated by adding the position increment argument to the (former) target position. The target position is the motion's end position and doesn't change during the execution of a motion command.

4.3.11 VAI Go To Pos From Act Pos And Act Vel (013xh)

Name	Byte Offset	Description	Type	Unit
Header	0	013xh: VAI Go To Pos From Act Pos And Act Vel	UInt16	-
1. Par	2	Target Position	SInt32	0.1 μm
2. Par	6	Maximal Velocity	UInt32	1E-6 m/s
3. Par	10	Acceleration	UInt32	1E-5 m/s ²
4. Par	14	Deceleration	UInt32	1E-5 m/s ²

This command starts the new VAI setpoint generation from the actual position and actual velocity. Can be used after a press command.

4.3.12 VAI Go To Pos From Act Pos Starting With Dem Vel = 0 (014xh)

Name	Byte Offset	Description	Type	Unit
Header	0	014xh: VAI Go To Pos From Act Pos Starting With Dem Vel =0	UInt16	-
1. Par	2	Target Position	UInt32	0.1 μm
2. Par	6	Maximal Velocity	UInt32	1E-6 m/s
3. Par	10	Acceleration	UInt32	1E-5 m/s ²
4. Par	14	Deceleration	UInt32	1E-5 m/s ²

This command starts the new VAI setpoint generation from the actual position and the start velocity is forced to zero. Can be used after a press command.

4.3.13 VAI Increment Act Pos (015xh)

Name	Byte Offset	Description	Type	Unit
Header	0	015xh: VAI Increment Act Pos	UInt16	-
1. Par	2	Position Increment	UInt32	0.1 μm
2. Par	6	Maximal Velocity	UInt32	1E-6 m/s
3. Par	10	Acceleration	UInt32	1E-5 m/s ²
4. Par	14	Deceleration	UInt32	1E-5 m/s ²

This command sets a new target position and defines the maximal velocity, acceleration and deceleration for going there. The new target position value will be determined by the firmware. It is calculated by adding the position increment argument to the actual position. The actual position is the effective motor position. This command can be used to perform a retraction move after a press command. If the position increment argument is zero, this command defines the actual motor position as new setpoint.

4.3.14 VAI Increment Act Pos Starting With Dem Vel = 0 (016xh)

Name	Byte Offset	Description	Type	Unit
Header	0	016xh: VAI Increment Act Pos Starting With Dem Vel = 0	UInt16	-
1. Par	2	Position Increment	UInt32	0.1 μm
2. Par	6	Maximal Velocity	UInt32	1E-6 m/s
3. Par	10	Acceleration	UInt32	1E-5 m/s ²
4. Par	14	Deceleration	UInt32	1E-5 m/s ²

This command starts the new VAI setpoint generation from the actual position and the start velocity is forced to zero. This command defines the maximal velocity, acceleration and deceleration for going to the target position. The new target position value will be determined by the firmware. It is calculated by adding the position increment argument to the actual position. The actual position is the effective motor position. This command can be used to perform a retraction move after a press command. If the position increment argument is zero, then this command defines the actual motor position as new setpoint.

4.3.15 VAI Stop (017xh)

Name	Byte Offset	Description	Type	Unit
Header	0	017xh: VAI Stop	UInt16	-
1. Par	2	Deceleration	UInt32	1E-5 m/s ²

4.3.16 VAI Go To Pos After Actual Command (018xh)

Name	Byte Offset	Description	Type	Unit
Header	0	018xh: VAI Go To Pos After Actual Command	UInt16	-
1. Par	2	Target Position	SInt32	0.1 μ m
2. Par	6	Maximal Velocity	UInt32	1E-6 m/s
3. Par	10	Acceleration	UInt32	1E-5 m/s ²
4. Par	14	Deceleration	UInt32	1E-5 m/s ²

This command waits until the actual motion setpoint generation has finished, then starts the new defined VAI motion.

4.3.17 VAI Go To Analog Pos (019xh)

Name	Byte Offset	Description	Type	Unit
Header	0	019xh: VAI Go To Analog Pos	UInt16	-
1. Par	2	Maximal Velocity	UInt32	1E-6 m/s
2. Par	6	Acceleration	UInt32	1E-5 m/s ²
3. Par	10	Deceleration	UInt32	1E-5 m/s ²

4.3.18 VAI Go To Pos On Rising Trigger Event (01Axh)

Name	Byte Offset	Description	Type	Unit
Header	0	01Axh: VAI Go To Pos On Rising Trigger Event	UInt16	-
1. Par	2	Target Position	SInt32	0.1 μ m
2. Par	6	Maximal Velocity	UInt32	1E-6 m/s
3. Par	10	Acceleration	UInt32	1E-5 m/s ²
4. Par	14	Deceleration	UInt32	1E-5 m/s ²

4.3.19 VAI Increment Target Pos On Rising Trigger Event (01Bxh)

Name	Byte Offset	Description	Type	Unit
Header	0	01Bxh: VAI Increment Target Pos On Rising Trigger Event	UInt16	-
1. Par	2	Position Increment	SInt32	0.1 μ m
2. Par	6	Maximal Velocity	UInt32	1E-6 m/s
3. Par	10	Acceleration	UInt32	1E-5 m/s ²
4. Par	14	Deceleration	UInt32	1E-5 m/s ²

4.3.20 VAI Go To Pos On Falling Trigger Event (01Cxh)

Name	Byte Offset	Description	Type	Unit
Header	0	01Cxh: VAI Go To Pos On Falling Trigger Event	UInt16	-
1. Par	2	Target Position	SInt32	0.1 um
2. Par	6	Maximal Velocity	UInt32	1E-6 m/s
3. Par	10	Acceleration	UInt32	1E-5 m/s ²
4. Par	14	Deceleration	UInt32	1E-5 m/s ²

4.3.21 VAI Increment Target Pos On Falling Trigger Event (01Dxh)

Name	Byte Offset	Description	Type	Unit
Header	0	01Dxh: VAI Increment Target Pos On Falling Trigger Event	UInt16	-
1. Par	2	Position Increment	SInt32	0.1 um
2. Par	6	Maximal Velocity	UInt32	1E-6 m/s
3. Par	10	Acceleration	UInt32	1E-5 m/s ²
4. Par	14	Deceleration	UInt32	1E-5 m/s ²

4.3.22 VAI Change Motion Parameters On Positive Position Transition (01Exh)

Name	Byte Offset	Description	Type	Unit
Header	0	01Exh: VAI Change Motion Parameters On Positive Position Transition	UInt16	-
1. Par	2	Transition Event Position	SInt32	0.1 um
2. Par	6	Max Velocity After Event	UInt32	1E-6 m/s
3. Par	10	Acceleration After Event	UInt32	1E-5 m/s ²
4. Par	14	Deceleration After Event	UInt32	1E-5 m/s ²

This motion command moves an event change position, an event maximal speed, an event acceleration and an event deceleration to the event instance, and starts the event evaluation. As soon as the demand position crosses the event change position in the positive direction the VAI is changed with event values, the target position rests unchanged.

4.3.23 VAI Change Motion Parameters On Negative Position Transition (01Fhx)

Name	Byte Offset	Description	Type	Unit
Header	0	01Fhx: VAI Change Motion Parameters On Negative Position Transition	UInt16	-
1. Par	2	Transition Event Position	SInt32	0.1 um
2. Par	6	Max Velocity After Event	UInt32	1E-6 m/s
3. Par	10	Acceleration After Event	UInt32	1E-5 m/s ²
4. Par	14	Deceleration After Event	UInt32	1E-5 m/s ²

This motion command moves an event change position, an event maximal speed, an event acceleration and an event deceleration to the event instance, and starts the event evaluation. As soon as the demand position crosses the event change position in the negative direction the VAI is changed with event values, the target position rests unchanged.

4.3.24 Predef VAI Go To Pos (020xh)

Name	Byte Offset	Description	Type	Unit
Header	0	020xh: Predef VAI Go To Pos	UInt16	-
1. Par	2	Target Position	SInt32	0.1 um

4.3.25 Predef VAI Increment Dem Pos (021xh)

Name	Byte Offset	Description	Type	Unit
Header	0	021xh: Predef VAI Increment Dem Pos	UInt16	-
1. Par	2	Position Increment	SInt32	0.1 um

4.3.26 Predef VAI Increment Target Pos (022xh)

Name	Byte Offset	Description	Type	Unit
Header	0	022xh: Predef VAI Increment Target Pos	UInt16	-
1. Par	2	Position Increment	SInt32	0.1 um

4.3.27 Predef VAI Go To Pos From Act Pos and Act Vel (023xh)

Name	Byte Offset	Description	Type	Unit
Header	0	023xh: Predef VAI Go To Pos From Act Pos And Act Vel	UInt16	-
1. Par	2	Target Position	SInt32	0.1 um

This command starts the new VAI setpoint generation from the actual position, can be used after a press command.

4.3.28 Predef VAI Go To Pos From Act Pos Starting With Dem Vel = 0 (024xh)

Name	Byte Offset	Description	Type	Unit
Header	0	024xh: Predef VAI Go To Pos From Act Pos With Dem Vel = 0	UInt16	-
1. Par	2	Target Position	SInt32	0.1 um

This command starts the new VAI-Setpoint generation from the actual position and the start velocity is forced to zero can be used after a press command.

4.3.29 Predef VAI Stop (027xh)

Name	Byte Offset	Description	Type	Unit
Header	0	017xh: Predef VAI Stop With Quick Stop Deceleration	UInt16	-

4.3.30 Predef VAI Go To Pos After Actual Command (028xh)

Name	Byte Offset	Description	Type	Unit
Header	0	028xh: Predef VAI Go To Pos After Actual Command	UInt16	-
1. Par	2	Target Position	SInt32	0.1 um

This command waits until the actual motion setpoint generation has finished, then starts the new defined VAI motion.

4.3.31 Predef VAI Go To Pos On Rising Trigger Event (02Axh)

Name	Byte Offset	Description	Type	Unit
Header	0	02Axh: Predef VAI Go To Pos On Rising Trigger Event	UInt16	-
1. Par	2	Target Position	SInt32	0.1 um

4.3.32 Predef VAI Increment Target Pos On Rising Trigger Event (02Bxh)

Name	Byte Offset	Description	Type	Unit
Header	0	02Bxh: Predef VAI Increment Target Pos On Rising Trigger Event	UInt16	-
1. Par	2	Position Increment	SInt32	0.1 um

4.3.33 Predef VAI Go To Pos On Falling Trigger Event (02Cxh)

Name	Byte Offset	Description	Type	Unit
Header	0	02Cxh: Predef VAI Go To Pos On Falling Trigger Event	UInt16	-
1. Par	2	Target Position	SInt32	0.1 um

4.3.34 Predef VAI Go To Pos On Falling Trigger Event (02Dxh)

Name	Byte Offset	Description	Type	Unit
Header	0	02Cxh: Predef VAI Go To Pos On Falling Trigger Event	UInt16	-
1. Par	2	Target Position	SInt32	0.1 um

4.3.35 Predef VAI Infinite Motion Positive Direction (02Exh)

Name	Byte Offset	Description	Type	Unit
Header	0	02Exh: Predef VAI Infinite Motion Positive Direction	UInt16	-

4.3.36 Predef VAI Infinite Motion Negative Direction (02Fhx)

Name	Byte Offset	Description	Type	Unit
Header	0	02Fhx: Predef VAI Infinite Motion Negative Direction	UInt16	-

4.3.37 P Stream With Slave Generated Time Stamp (030xh)

Name	Byte Offset	Description	Type	Unit
Header	0	030xh: P Stream With Slave Generated Time Stamp	UInt16	-
1. Par	2	Position	SInt32	0.1 um

Position streaming mode: The time stamp is generated by the interface (receive time stamp of T0), the streaming period has to be in the time range 2..5ms. For good results the streaming period has to be as constant as possible.

4.3.38 PV Stream With Slave Generated Time Stamp (031xh)

Name	Byte Offset	Description	Type	Unit
Header	0	031xh: PVA Stream With Slave Generated Time Stamp	UInt16	-
1. Par	2	Position	SInt32	0.1 um
2. Par	6	Velocity	SInt32	1 um/s

Position and velocity streaming mode: Preferred streaming mode. The time stamp is generated by the interface (receive time stamp of T0), the streaming period has to be in the time range 2..5ms. Less sensitive to deviations of the streaming period.

4.3.39 P Stream With Slave Generated Time Stamp and Configured Period Time (032xh)

Name	Byte Offset	Description	Type	Unit
Header	0	032xh: P Stream With Slave Generated Time Stamp and Configured Period Time	UInt16	-
1. Par	2	Position	SInt32	0.1 um

Position streaming mode: The time stamp is generated by the interface (receive time stamp of T0), the streaming period has to be in the time range 2..5ms. For good results the streaming period has to be as constant as possible. For the derivation of the velocity and the acceleration the configured streaming period time 14E6h is taken to minimize communication time jittering.

4.3.40 Stop Streaming (03Fhx)

Name	Byte Offset	Description	Type	Unit
Header	0	03Fhx: Stop Streaming	UInt16	-

This command is used to leave the streaming mode.

4.3.41 Time Curve With Default Parameters (040xh)

Name	Byte Offset	Description	Type	Unit
Header	0	040xh: Time Curve With Default Parameters	UInt16	-
1. Par	2	Curve ID	UInt16	1..100

4.3.42 Time Curve With Default Parameters From Act Pos (041xh)

Name	Byte Offset	Description	Type	Unit
Header	0	41xh: Time Curve With Default Parameters From Act Pos	UInt16	-
1. Par	2	Curve ID	UInt16	1..100

This command sets the curve offset to the actual position set point then starts the specified time curve with the default parameters (curve time scaling and curve amplitude scaling).

4.3.43 Time Curve To Pos With Default Speed (042xh)

Name	Byte Offset	Description	Type	Unit
Header	0	042xh: Time Curve To Pos With Default Speed	UInt16	-
1. Par	2	Curve ID	UInt16	1..100
2. Par	4	Target Position	SInt32	0.1 um

This command sets the curve offset to the actual demand position and scales the curve the way that the target position is reached at the end (the scaling range is -2000%..2000%, if this range is exceeded an error will be generated) then starts the specified time curve with the default curve speed parameter.

4.3.44 Time Curve To Pos With Adjustable Time (043xh)

Name	Byte Offset	Description	Type	Unit
Header	0	043xh: Time Curve To Pos With Adjustable Time	UInt16	-
1. Par	2	Curve ID	UInt16	1..100
2. Par	4	Target Position	SInt32	0.1 um
3. Par	8	Curve Time	SInt32	10us

This command sets the curve offset to the demand position and scales the curve the way that the target position is reached at the end (the scaling range is -2000%..2000%, if this range is exceeded an error will be generated). The curve time is taken from the motion command.

4.3.45 Time Curve With Adjustable Offset, Time Scale & Amplitude Scale (044xh)

Name	Byte Offset	Description	Type	Unit
Header	0	044xh: Time Curve With Adjustable Offset, Time Scale & Amplitude Scale	UInt16	-
1. Par	2	Curve ID	UInt16	1..100
2. Par	4	Curve Offset	SInt32	0.1 um
3. Par	8	Time Scale	UInt16	0.01%
4. Par	10	Amplitude Scale	SInt16	0.1%

With this command all the curve parameters are defined.

4.3.46 Time Curve With Adjustable Offset, Time & Amplitude Scale (045xh)

Name	Byte	Description	Type	Unit
------	------	-------------	------	------

	Offset			
Header	0	045xh: Time Curve With Adjustable Offset, Time & Amplitude Scale	UInt16	-
1. Par	2	Curve ID	UInt16	1..100
2. Par	4	Curve Offset	SInt32	0.1 um
3. Par	8	Curve Time	SInt32	10us
4. Par	12	Amplitude Scale	SInt16	0.1%

With this command all the curve parameters are defined, unlike command 44xh this command defines the absolute curve time.

4.3.47 Time Curve With Adjustable Offset, Time & Amplitude Scale On Rising Trigger Event (046xh)

Name	Byte Offset	Description	Type	Unit
Header	0	046xh: Time Curve With Adjustable Offset, Time & Amplitude Scale On Rise Trigger Event	UInt16	-
1. Par	2	Curve ID	UInt16	1..100
2. Par	4	Curve Offset	SInt32	0.1 um
3. Par	8	Curve Time	SInt32	10us
4. Par	12	Amplitude Scale	SInt16	0.1%

On a rising trigger event start command 045xh.

4.3.48 Time Curve With Adjustable Offset, Time & Amplitude Scale On Falling Trigger Event (047xh)

Name	Byte Offset	Description	Type	Unit
Header	0	047xh: Time Curve With Adjustable Offset, Time & Amplitude Scale On Falling Trigger Event	UInt16	-
1. Par	2	Curve ID	UInt16	1..100
2. Par	4	Curve Offset	SInt32	0.1 um
3. Par	8	Curve Time	SInt32	10us
4. Par	12	Amplitude Scale	SInt16	0.1%

On a falling trigger event start command 045xh.

4.3.49 Time Curve To Pos With Default Speed On Rising Trigger Event (04Axh)

Name	Byte Offset	Description	Type	Unit
Header	0	04Axh: Time Curve To Pos With Default Speed On Rising Trigger Event	UInt16	-
1. Par	2	Curve ID	UInt16	1..100
2. Par	4	Target Position	SInt32	0.1 um

On a rising trigger event start command 042xh.

4.3.50 Time Curve To Pos With Default Speed On Falling Trigger Event (04Cxh)

Name	Byte Offset	Description	Type	Unit
------	-------------	-------------	------	------

Header	0	04Cxh: Time Curve To Pos With Default Speed On Falling Trigger Event	UInt16	-
1. Par	2	Curve ID	UInt16	1..100
2. Par	4	Target Position	SInt32	0.1 um

On a falling trigger event start command 042xh.

4.3.51 Time Curve To Pos With Adjustable Time On Rising Trigger Event (04Exh)

Name	Byte Offset	Description	Type	Unit
Header	0	04Exh: Time Curve Go To Absolute Position With Adjustable Time On Rising Trigger Event	UInt16	-
1. Par	2	Curve ID	UInt16	1..100
2. Par	4	Target Position	SInt32	0.1 um
3. Par	8	Curve Time	SInt32	10us

On a rising trigger event start command 043xh.

4.3.52 Time Curve To Pos With Adjustable Time On Falling Trigger Event (04Fhx)

Name	Byte Offset	Description	Type	Unit
Header	0	04Fhx: Time Curve To Pos With Adjustable Time On Falling Trigger Event	UInt16	-
1. Par	2	Curve ID	UInt16	1..100
2. Par	4	Target Position	SInt32	0.1 um
3. Par	8	Curve Time	SInt32	10us

On a falling trigger event start command 043xh.

4.3.53 Modify Curve Start Address in RAM (050xh)

Name	Byte Offset	Description	Type	Unit
Header	0	050xh: Modify Curve Start Address in RAM	UInt16	-
1. Par	2	Curve ID	UInt16	1..100
2. Par	4	Curve Start Address Offset	UInt16	-

This command allows locating the curve start address (points to the start of the curve info header). A value of 0FFFh means no curve has been defined, can be used to clear a curve. When using this command the whole memory management of the curve data has to be done by the superior system! A curve can only be defined with a valid start address. If a start address is defined, the curve (curve info header and curve data points) has to be completely defined, otherwise this will lead to an unpredictable behavior!

4.3.54 Modify Curve Info Block 16 Bit Value in RAM (051xh)

Name	Byte Offset	Description	Type	Unit
Header	0	051xh: Modify Curve Info Block 16 Bit Value in RAM	UInt16	-

1. Par	2	Curve ID	UInt16	1..100
2. Par	4	Offset in Byte	UInt16	0..
3. Par	6	Value	Sint16	-

This command allows to modify a 16 bit value (or half of a 32 bit value) in RAM within the curve info block of an existing curve profile with the given ID. The offset argument defines on which position within the curve info block the modification takes place (byte offset). In order to modify for instance the value of x-Length you first have to set the low word of the new curve length with Offset 32 and then the high word with offset 34.

The fieldbus interfaces (CANOpen, DeviceNet, Profibus, LinRS, POWERLINK, EtherCAT) offer a safer way to download and modify curve profiles (Curve Service). Writing with wrong offsets, may overwrite and destroy data of other curves and may lead to unpredictable behavior!

4.3.55 Modify Curve Info Block 32 Bit Value in RAM (052xh)

Name	Byte Offset	Description	Type	Unit
Header	0	052xh: Modify Curve Info Block 32 Bit Value in RAM	UInt16	-
1. Par	2	Curve ID	UInt16	1..100
2. Par	4	Offset in Byte	UInt16	0..
3. Par	6	Value	Sint32	-

This command allows to modify a 32 bit value in RAM within the curve data block of an already existing curve profile with the given ID. The offset argument defines on which position within the curve data block the modification takes place (byte offset). In order to modify for instance the first position setpoint value (SInt32) you have to set the new position with offset 0. The second setpoint has offset 4, and so on.

The fieldbus interfaces (CANOpen, DeviceNet, Profibus, LinRS, POWERLINK, EtherCAT) offer a safer way to download and modify curve profiles (Curve Service). Writing with wrong offsets, may overwrite and destroy data of other curves and may lead to unpredictable behavior!

4.3.56 Modify Curve Data Block 32 Bit Value in RAM (054xh)

Name	Byte Offset	Description	Type	Unit
Header	0	054xh: Modify Curve Data Block 32 Bit Value in RAM	UInt16	-
1. Par	2	Curve ID	UInt16	1..100
2. Par	4	Offset in Byte	UInt16	0..
3. Par	6	Curve point value	Sint32	-

This command allows to modify in RAM a 32 bit value within the Curve Data Block of a curve with existing curve start address and curve info header block with the given ID. The offset argument defines on which position within the curve data block the modification takes place (byte offset). In order to modify for instance the first position setpoint value (SInt32) you have to set the new position with offset 0. The second setpoint has offset 4, and so on. The fieldbus interfaces (CANOpen, DeviceNet, Profibus, LinRS, POWERLINK, EtherCAT) offer a safer way to download and modify curve profiles (Curve Service). Writing with wrong offsets, may overwrite and destroy data of other curves and may lead to unpredictable behavior!

4.3.57 Modify Curve Data Block 64 Bit Value in RAM (055xh)

Name	Byte	Description	Type	Unit
------	------	-------------	------	------

	Offset			
Header	0	055xh: Modify Curve Data Block 64 Bit Value in RAM	UInt16	-
1. Par	2	Curve ID	UInt16	1..100
2. Par	4	Offset in Byte	UInt16	0..
3. Par	6	Curve point value	Sint32	-
4. Par	10	Curve point value	Sint32	-

This command allows to modify in RAM two 32 bit value within the curve data block of a curve with existing curve start address and curve info header block with the given ID. The offset argument defines on which position within the curve data block the modification takes place (byte offset). In order to modify for instance the first position setpoint value (Sint32) you have to set the new position with offset 0. The second setpoint has offset 4, and so on. The fieldbus interfaces (CANOpen, DeviceNet, Profibus, LinRS, POWERLINK, EtherCAT) offer a safer way to download and modify curve profiles (Curve Service). Writing with wrong offsets, may overwrite and destroy data of other curves and may lead to unpredictable behavior!

4.3.58 Modify Curve Data Block 96 Bit Value in RAM (056xh)

Name	Byte Offset	Description	Type	Unit
Header	0	056xh: Modify Curve Data Block 96 Bit Value in RAM	UInt16	-
1. Par	2	Curve ID	UInt16	1..100
2. Par	4	Offset in Byte	UInt16	0..
3. Par	6	Curve point value	Sint32	-
4. Par	10	Curve point value	Sint32	-
5. Par	14	Curve point value	Sint32	-

This command allows to modify in RAM three 32 bit value within the curve data block of a curve with existing curve start address and curve info header block with the given ID. The offset argument defines on which position within the curve data block the modification takes place (byte offset). In order to modify for instance the first position setpoint value (Sint32) you have to set the new position with offset 0. The second setpoint has offset 4, and so on. The fieldbus interfaces (CANOpen, DeviceNet, Profibus, LinRS, POWERLINK, EtherCAT) offer a safer way to download and modify curve profiles (Curve Service). Writing with wrong offsets, may overwrite and destroy data of other curves and may lead to unpredictable behavior!

4.3.59 Setup Encoder Cam On Rising Trigger Event With Delay Counts (069xh)

Name	Byte Offset	Description	Type	Unit
Header	0	069xh: Setup Encoder Cam On Rising Trigger Event With Delay Counts	UInt16	-
1. Par	2	Curve ID	UInt16	1..100
2. Par	4	Curve Start Delay Count	UInt32	1 Incr

Setup in the event handler to start a cam curve on the rising trigger event with the specified curve ID and the specified delay counts. The specified curve ID is written to the RAM value of UPID 154Ah, and the specified cam start delay is written to the RAM value of UPID 154Ch. Use the infinite cam Length (UPID1527h) for triggered cam motions.

4.3.60 Setup Encoder Cam On Rising Trigger Event With Delay Counts, Target Pos and Length (06Axx)

Name	Byte Offset	Description	Type	Unit
Header	0	06Axx: Setup Encoder Cam On Rise Trigger Event With Delay Counts, Target Pos and Length	UInt16	-
1. Par	2	Curve ID	UInt16	1..100
2. Par	4	Curve Start Delay Count	SInt32	1 Incr
3. Par	8	Target Position	SInt32	0.1 um
4. Par	12	Curve length	SInt32	1 Incr

Setup in the event handler to start a cam curve on the rising trigger event with the specified curve ID and the specified delay counts to specified target position in specified counts. The specified curve ID is written to the RAM value of UPID 154Ah, and the specified cam start delay is written to the RAM value of UPID 154Ch. Use the infinite cam length (UPID1527h) for triggered cam motions.

4.3.61 Setup Encoder Cam On Falling Trigger Event With Delay Counts (06Bxx)

Name	Byte Offset	Description	Type	Unit
Header	0	06Bxx: Setup Encoder Cam On Falling Trigger Event With Delay Counts	UInt16	-
1. Par	2	Curve ID	UInt16	1..100
2. Par	4	Curve Start Delay Count	UInt32	1 Incr

Setup in the event handler to start a cam curve on the falling trigger event with the specified curve ID and the specified delay counts. The specified curve ID is written to the RAM value of UPID 154Bh, and the specified cam start delay is written to the RAM value of UPID 154Dh. Use the infinite cam length (UPID1527h) for triggered cam motions.

4.3.62 Setup Encoder Cam On Falling Trigger Event With Delay Counts, Target Pos and Length (06Cxx)

Name	Byte Offset	Description	Type	Unit
Header	0	06Cxx: Setup Encoder Cam On Falling Trigger Event With Delay Counts, Target Pos and Length	UInt16	-
1. Par	2	Curve ID	UInt16	1..100
2. Par	4	Curve Start Delay Count	SInt32	1 Incr
3. Par	8	Target Position	SInt32	0.1 um
4. Par	12	Curve length	SInt32	1 Incr

Setup in the event handler to start a cam curve on the falling trigger event with the specified curve ID and the specified delay counts to specified target position in specified counts. The specified curve ID is written to the RAM value of UPID 154Bh, and the specified cam start delay is written to the RAM value of UPID 154Dh. Use the infinite cam length (UPID1527h) for triggered cam motions.

4.3.63 Setup Encoder Cam On Rising Trigger Event With Delay Counts, Amplitude scale and Length (06Dxx)

Name	Byte Offset	Description	Type	Unit
------	-------------	-------------	------	------

Header	0	06Dxh: Setup Encoder Cam On Rise Trigger Event With Delay Counts, Amplitude scale and Length	UInt16	-
1. Par	2	Curve ID	UInt16	1..100
2. Par	4	Curve Start Delay Count	SInt32	1 Incr
3. Par	8	Amplitude Scale	Sint16	0.1 %
4. Par	10	Curve length in Counts	SInt32	1 Incr

Setup in the event handler to start a cam curve on the rising trigger event with the specified curve ID and the specified delay counts to specified target position in specified counts. The specified curve ID is written to the RAM value of UPID 154Ah, and the specified cam start delay is written to the RAM value of UPID 154Ch. Use the infinite cam length (UPID1527h) for triggered cam motions.

4.3.64 Setup Encoder Cam On Falling Trigger Event With Delay Counts, Amplitude scale and Length (06Exh)

Name	Byte Offset	Description	Type	Unit
Header	0	06Exh: Setup Encoder Cam On Fall Trigger Event With Delay Counts, Amplitude scale and Length	UInt16	-
1. Par	2	Curve ID	UInt16	1..100
2. Par	4	Curve Start Delay Count	SInt32	1 Incr
3. Par	8	Amplitude Scale	Sint16	0.1 %
4. Par	10	Curve length in Counts	SInt32	1 Incr

Setup in the event handler to start a cam curve on the rising trigger event with the specified curve ID and the specified delay counts to specified target position in specified counts. The specified curve ID is written to the RAM value of UPID 154Ah, and the specified cam start delay is written to the RAM value of UPID 154Ch. Use the infinite cam length (UPID1527h) for triggered cam motions.

4.3.65 Start VAI Encoder Position Indexing (070xh)

Name	Byte Offset	Description	Type	Unit
Header	0	070xh: Start VAI Encoder Position Indexing	UInt16	-
1. Par	2	Target Position	SInt32	0.1 um
2. Par	6	Maximal Velocity	UInt32	1E-6 m/s
3. Par	10	Acceleration	UInt32	1E-5 m/s ²
4. Par	14	Deceleration	UInt32	1E-5 m/s ²

Changes to the VAI encoder position indexing mode, the actual encoder count is to the target position. To stop the indexing mode use one of the commands (008xh), (07Exh) or (07Fxh).

4.3.66 Start Predef VAI Encoder Position Indexing (071xh)

Name	Byte Offset	Description	Type	Unit
Header	0	071xh: Start Predef VAI Encoder Position Indexing	UInt16	-
1. Par	2	Target Position	SInt32	0.1 um

Changes to the VAI encoder position indexing mode, the actual encoder count is to the target position. The VAI parameters maximal velocity, acceleration and deceleration are ones taken at calling time from the predefined VAI parameter set (UPIDs: 14BEh, 14BF and 14C0h). To stop the indexing mode use one of the commands (008xh), (07Exh) or (07Fhx).

4.3.67 Stop Position Indexing and VAI Go To Pos (07Exh)

Name	Byte Offset	Description	Type	Unit
Header	0	07Exh: Stop Position Indexing And VAI Go To Pos	UInt16	-
1. Par	2	Target Position	SInt32	0.1 um
2. Par	6	Maximal Velocity	UInt32	1E-6 m/s
3. Par	10	Acceleration	UInt32	1E-5 m/s ²
4. Par	14	Deceleration	UInt32	1E-5 m/s ²

This command stops the position indexing mode and moves to the defined target position with a VAI command.

4.3.68 Stop Position Indexing and VAI Go To Pos (07Fhx)

Name	Byte Offset	Description	Type	Unit
Header	0	07Vxh: Stop Position Indexing And VAI Go To Pos	UInt16	-
1. Par	2	Target Position	SInt32	0.1 um

This command clears the position indexing mode and moves to the defined target position with a Predefined VAI command.

4.3.69 VAI 16 Bit Go To Pos (090xh)

Name	Byte Offset	Description	Type	Unit
Header	0	090xh: VAI 16 Bit Go To Pos	UInt16	-
1. Par	2	Target Position	SInt16	Scaled
2. Par	4	Maximal Velocity	UInt16	Scaled
3. Par	6	Acceleration	UInt16	Scaled
4. Par	8	Deceleration	UInt16	Scaled

This command is similar to the 010xh command, but the parameters are only 16 bit and scaled. The scaling is according to the parameter settings under \Motion Control SW\ Motion Interface\ 16 Bit Interface Scaling\.

4.3.70 VAI 16 Bit Increment Dem Pos (091xh)

Name	Byte Offset	Description	Type	Unit
Header	0	091xh: VAI 16 Bit Go To Relative Position	UInt16	-
1. Par	2	Position Increment	SInt16	Scaled
2. Par	4	Maximal Velocity	UInt16	Scaled
3. Par	6	Acceleration	UInt16	Scaled
4. Par	8	Deceleration	UInt16	Scaled

4.3.71 VAI 16 Bit Increment Target Pos (092xh)

Name	Byte Offset	Description	Type	Unit
Header	0	092xh: VAI 16 Bit Increment Target Pos	UInt16	-

1. Par	2	Position Increment	SInt16	Scaled
2. Par	4	Maximal Velocity	UInt16	Scaled
3. Par	6	Acceleration	UInt16	Scaled
4. Par	8	Deceleration	UInt16	Scaled

4.3.72 VAI 16 Bit Go To Pos From Act Pos And Act Vel (093xh)

Name	Byte Offset	Description	Type	Unit
Header	0	093xh: VAI 16 Bit Go To Pos From Act Pos And Act Vel	UInt16	-
1. Par	2	Target Position	SInt16	Scaled
2. Par	4	Maximal Velocity	UInt16	Scaled
3. Par	6	Acceleration	UInt16	Scaled
4. Par	8	Deceleration	UInt16	Scaled

This command starts the new VAI setpoint generation from the actual position, can be used after a press command.

4.3.73 VAI 16 Bit Go To Pos From Act Pos Starting With Dem Vel = 0 (094xh)

Name	Byte Offset	Description	Type	Unit
Header	0	094xh: VAI 16 Bit Go To Pos From Act Pos Starting With Dem Vel = 0	UInt16	-
1. Par	2	Target Position	SInt16	Scaled
2. Par	4	Maximal Velocity	UInt16	Scaled
3. Par	6	Acceleration	UInt16	Scaled
4. Par	8	Deceleration	UInt16	Scaled

This command starts a the new VAI-Setpoint generation from the actual position and the start velocity is forced to zero. Can be used after a press command.

4.3.74 VAI 16 Bit Increment Act Pos (095xh)

Name	Byte Offset	Description	Type	Unit
Header	0	095xh: VAI 16 Bit Increment Act Pos	UInt16	-
1. Par	2	Position Increment	SInt16	Scaled
2. Par	4	Maximal Velocity	UInt16	Scaled
3. Par	6	Acceleration	UInt16	Scaled
4. Par	8	Deceleration	UInt16	Scaled

4.3.75 VAI 16 Bit Increment Act Pos Starting With Dem Vel = 0 (096xh)

Name	Byte Offset	Description	Type	Unit
Header	0	096xh: VAI 16 Bit Increment Act Pos	UInt16	-
1. Par	2	Position Increment	SInt16	Scaled
2. Par	4	Maximal Velocity	UInt16	Scaled
3. Par	6	Acceleration	UInt16	Scaled
4. Par	8	Deceleration	UInt16	Scaled

4.3.76 VAI 16 Bit Stop (097xh)

Name	Byte Offset	Description	Type	Unit
Header	0	097xh: VAI 16 Bit Stop	UInt16	-
1. Par	2	Deceleration	UInt16	Scaled

4.3.77 VAI 16 Bit Go To Pos After Actual Command (098xh)

Name	Byte Offset	Description	Type	Unit
Header	0	098xh: VAI 16 Bit Go To Pos After Actual Command	UInt16	-
1. Par	2	Target Position	SInt16	Scaled
2. Par	4	Maximal Velocity	UInt16	Scaled
3. Par	6	Acceleration	UInt16	Scaled
4. Par	8	Deceleration	UInt16	Scaled

This command waits until the actual motion setpoint generation has finished, then starts the new defined VAI motion.

4.3.78 VAI 16 Bit Go To Pos On Rising Trigger Event (09Axh)

Name	Byte Offset	Description	Type	Unit
Header	0	9Axh: VAI 16 Bit Go To Pos On Rising Trigger Event	UInt16	-
1. Par	2	Target Position	SInt16	Scaled
2. Par	4	Maximal Velocity	UInt16	Scaled
3. Par	6	Acceleration	UInt16	Scaled
4. Par	8	Deceleration	UInt16	Scaled

4.3.79 VAI 16 Bit Increment Target Pos On Rising Trigger Event (09Bxh)

Name	Byte Offset	Description	Type	Unit
Header	0	9Bxh: VAI 16 Bit Increment Target Pos On Rising Trigger Event	UInt16	-
1. Par	2	Position Increment	SInt16	Scaled
2. Par	4	Maximal Velocity	UInt16	Scaled
3. Par	6	Acceleration	UInt16	Scaled
4. Par	8	Deceleration	UInt16	Scaled

4.3.80 VAI 16 Bit Go To Pos On Falling Trigger Event (09Cxh)

Name	Byte Offset	Description	Type	Unit
Header	0	09Cxh: VAI 16 Bit Go To Pos On Falling Trigger Event	UInt16	-
1. Par	2	Target Position	SInt16	Scaled
2. Par	4	Maximal Velocity	UInt16	Scaled
3. Par	6	Acceleration	UInt16	Scaled
4. Par	8	Deceleration	UInt16	Scaled

4.3.81 VAI 16 Bit Increment Target Pos On Falling Trigger Event (09Dxh)

Name	Byte Offset	Description	Type	Unit
Header	0	09Dxh: VAI 16 Bit Increment Target Pos On Falling Trigger Event	UInt16	-
1. Par	2	Position Increment	SInt16	Scaled
2. Par	4	Maximal Velocity	UInt16	Scaled
3. Par	6	Acceleration	UInt16	Scaled
4. Par	8	Deceleration	UInt16	Scaled

4.3.82 VAI 16 Bit Change Motion Parameters On Positive Position Transition (09Exh)

Name	Byte Offset	Description	Type	Unit
Header	0	09Exh: VAI 16 Bit Change Motion Parameters On Positive Position Transition	UInt16	-
1. Par	2	Transition Event Position	SInt16	Scaled
2. Par	4	Max Velocity After Event	UInt16	Scaled
3. Par	6	Acceleration After Event	UInt16	Scaled
4. Par	8	Deceleration After Event	UInt16	Scaled

As soon as the demand position crosses the event change position in positive direction the parameters for velocity, acceleration and deceleration will be changed to the values defined in the command.

4.3.83 VAI 16 Bit Change Motion Parameters On Negative Position Transition (09Fhx)

Name	Byte Offset	Description	Type	Unit
Header	0	09Fhx: VAI Change Motion Parameters on Negative Position Transition	UInt16	-
1. Par	2	Transition Event Position	SInt16	Scaled
2. Par	4	Max Velocity After Event	UInt16	Scaled
3. Par	6	Acceleration After Event	UInt16	Scaled
4. Par	8	Deceleration After Event	UInt16	Scaled

As soon as the demand position crosses the event change position in negative direction the parameters for velocity, acceleration and deceleration will be changed to the values defined in the command.

4.3.84 Predef VAI 16 Bit Go To Pos (0A0xh)

Name	Byte Offset	Description	Type	Unit
Header	0	0A0xh: Predef VAI 16 Bit Go To Pos	UInt16	-
1. Par	2	Target Position	SInt16	Scaled

4.3.85 Predef VAI 16 Bit Increment Dem Pos (0A1xh)

Name	Byte Offset	Description	Type	Unit
Header	0	0A1xh: Predef VAI 16 Bit Increment Dem Pos	UInt16	-
1. Par	2	Position Increment	Slnt16	Scaled

4.3.86 Predef VAI 16 Bit Increment Target Pos (0A2xh)

Name	Byte Offset	Description	Type	Unit
Header	0	0A2xh: Predef VAI 16 Bit Increment Target Pos	UInt16	-
1. Par	2	Position Increment	Slnt16	Scaled

4.3.87 Predef VAI 16 Bit Go To Pos From Act Pos And Act Vel (0A3xh)

Name	Byte Offset	Description	Type	Unit
Header	0	0A3xh: VAI 16 Bit Go To Pos From Act Pos And Act Vel	UInt16	-
1. Par	2	Target Position	Slnt16	Scaled

This command starts a new VAI setpoint generation from the actual position, can be used after a press command.

4.3.88 Predef VAI 16 Bit Go To Pos From Act Pos Starting With Dem Vel = 0 (0A4xh)

Name	Byte Offset	Description	Type	Unit
Header	0	0A4xh: Predef VAI 16 Bit Go To Pos From Act Pos Starting With Dem Vel = 0	UInt16	-
1. Par	2	Target Position	Slnt16	Scaled

This command starts a new VAI setpoint generation from the actual position and the start velocity is forced to zero. Can be used after a press command.

4.3.89 Predef VAI 16 Bit Stop (0A7xh)

Name	Byte Offset	Description	Type	Unit
Header	0	0A7xh: Predef VAI Stop With Quick Stop Deceleration	UInt16	-

4.3.90 Predef VAI 16 Bit Go To Pos After Actual Command (0A8xh)

Name	Byte Offset	Description	Type	Unit
Header	0	0A8xh: Predef VAI 16 Bit Go To Pos After Actual Command	UInt16	-
1. Par	2	Target Position	Slnt16	Scaled

This command waits until the actual motion setpoint generation has finished, then starts the new defined VAI motion.

4.3.91 Predef VAI 16 Bit Go To Pos On Rising Trigger Event (0AAxh)

Name	Byte Offset	Description	Type	Unit
Header	0	0AAxh: Predef VAI 16 Bit Go To Pos On Rising Trigger Event	UInt16	-
1. Par	2	Target Position	Slnt16	Scaled

4.3.92 Predef VAI 16 Bit Increment Target Pos On Rising Trigger Event (0ABxh)

Name	Byte Offset	Description	Type	Unit
Header	0	0ABxh: Predef VAI 16 Bit Increment Target Pos On Rising Trigger Event	UInt16	-
1. Par	2	Position Increment	Slnt16	Scaled

4.3.93 Predef VAI 16 Bit Go To Pos On Falling Trigger Event (0ACxh)

Name	Byte Offset	Description	Type	Unit
Header	0	0ACxh: VAI 16 Bit Go To Pos On Falling Trigger Event	UInt16	-
1. Par	2	Target Position	Slnt32	0.1 um

4.3.94 Predef VAI 16 Bit Increment Target Pos On Falling Trigger Event (0ADxh)

Name	Byte Offset	Description	Type	Unit
Header	0	0ADxh: Predef VAI 16 Bit Increment Target Pos On Falling Trigger Event	UInt16	-
1. Par	2	Target Position	Slnt16	Scaled

4.3.95 VAI Predef Acc Go To Pos (0B0xh)

Name	Byte Offset	Description	Type	Unit
Header	0	0B0xh: VAI Predef Acc Go To Pos	UInt16	-
1. Par	2	Target Position	Slnt32	0.1 um
2. Par	6	Maximal Velocity	UInt32	1E-6 m/s

4.3.96 VAI Predef Acc Increment Dem Pos (0B1xh)

Name	Byte Offset	Description	Type	Unit
Header	0	0B1xh:VAI Predef Acc Increment Dem Pos	UInt16	-
1. Par	2	Position Increment	Slnt32	0.1 um
2. Par	6	Maximal Velocity	UInt32	1E-6 m/s

4.3.97 VAI Predef Acc Increment Target Pos (0B2xh)

Name	Byte Offset	Description	Type	Unit
Header	0	0B2xh: VAI Predef Acc Increment Target Pos	UInt16	-
1. Par	2	Position Increment	Slnt32	0.1 um
2. Par	6	Maximal Velocity	UInt32	1E-6 m/s

4.3.98 VAI Predef Acc Go To Pos From Act Pos And Act Vel (0B3xh)

Name	Byte Offset	Description	Type	Unit
Header	0	0B3xh: VAI Predef Acc Go To Pos From Act Pos And Act Vel	UInt16	-
1. Par	2	Target Position	Slnt32	0.1 μ m
2. Par	6	Maximal Velocity	UInt32	1E-6 m/s

This command starts a new VAI setpoint generation from the actual position and with actual velocity. Can be used after a press command.

4.3.99 VAI Predef Acc Go To Pos From Act Pos Starting With Dem Vel = 0 (0B4xh)

Name	Byte Offset	Description	Type	Unit
Header	0	0B4xh: VAI Predef Acc Go To Pos From Act Pos Starting With Dem Vel =0	UInt16	-
1. Par	2	Target Position	Slnt32	0.1 μ m
2. Par	6	Maximal Velocity	UInt32	1E-6 m/s

This command starts a new VAI setpoint generation from the actual position and the start velocity is forced to zero. Can be used after a press command.

4.3.100 VAI Predef Acc Go To Pos After Actual Command (0B8xh)

Name	Byte Offset	Description	Type	Unit
Header	0	0B8xh: VAI Predef Acc Go To Pos After Actual Command	UInt16	-
1. Par	2	Target Position	Slnt32	0.1 μ m
2. Par	6	Maximal Velocity	UInt32	1E-6 m/s

This command waits until the actual motion setpoint generation has finished, then starts the new defined VAI motion.

4.3.101 VAI Predef Acc Go To Pos On Rising Trigger Event (0BAxh)

Name	Byte Offset	Description	Type	Unit
Header	0	0BAxh: VAI Predef Acc Go To Pos On Rising Trigger Event	UInt16	-
1. Par	2	Target Position	Slnt32	0.1 μ m
2. Par	6	Maximal Velocity	UInt32	1E-6 m/s

4.3.102 VAI Predef Acc Increment Target Pos On Rising Trigger Event (0BBxh)

Name	Byte Offset	Description	Type	Unit
Header	0	0BBxh: VAI Predef Acc Increment Target Pos On Rising Trigger Event	UInt16	-
1. Par	2	Position Increment	Slnt32	0.1 μ m
2. Par	6	Maximal Velocity	UInt32	1E-6 m/s

4.3.103 VAI Predef Acc Go To Pos On Falling Trigger Event (0BCxh)

Name	Byte Offset	Description	Type	Unit
Header	0	0BCxh: VAI Predef Acc Go To Pos On Falling Trigger Event	UInt16	-
1. Par	2	Target Position	Slnt32	0.1 μ m
2. Par	6	Maximal Velocity	UInt32	1E-6 m/s

4.3.104 VAI Predef Acc Increment Target Pos On Falling Trigger Event (0BDxh)

Name	Byte Offset	Description	Type	Unit
Header	0	0BDxh: VAI Predef Acc Increment Target Pos On Falling Trigger Event	UInt16	-
1. Par	2	Position Increment	Slnt32	0.1 μ m
2. Par	6	Maximal Velocity	UInt32	1E-6 m/s

4.3.105 VAI Dec=Acc Go To Pos (0C0xh)

Name	Byte Offset	Description	Type	Unit
Header	0	0C0xh: VAI Dec=Acc Go To Pos	UInt16	-
1. Par	2	Target Position	Slnt32	0.1 μ m
2. Par	6	Maximal Velocity	UInt32	1E-6 m/s
3. Par	10	Acceleration = Deceleration	UInt32	1E-5 m/s ²

4.3.106 VAI Dec=Acc Increment Dem Pos (0C1xh)

Name	Byte Offset	Description	Type	Unit
Header	0	0C1xh:VAI Dec=Acc Increment Dem Pos	UInt16	-
1. Par	2	Position Increment	Slnt32	0.1 μ m
2. Par	6	Maximal Velocity	UInt32	1E-6 m/s
3. Par	10	Acceleration = Deceleration	UInt32	1E-5 m/s ²

4.3.107 VAI Dec=Acc Increment Target Pos (0C2xh)

Name	Byte Offset	Description	Type	Unit
Header	0	0C2xh: VAI Dec=Acc Increment Target Pos	UInt16	-
1. Par	2	Position Increment	Slnt32	0.1 μ m
2. Par	6	Maximal Velocity	UInt32	1E-6 m/s
3. Par	10	Acceleration = Deceleration	UInt32	1E-5 m/s ²

4.3.108 VAI Dec=Acc Go To Pos From Act Pos And Act Vel (0C3xh)

Name	Byte Offset	Description	Type	Unit
Header	0	0C3xh: VAI Dec=Acc Go To Pos From Act Pos And Act Vel	UInt16	-
1. Par	2	Target Position	Slnt32	0.1 μ m
2. Par	6	Maximal Velocity	UInt32	1E-6 m/s
3. Par	10	Acceleration = Deceleration	UInt32	1E-5 m/s ²

This command starts a new VAI setpoint generation from the actual position and actual velocity. Can be used after a press command.

4.3.109 VAI Dec=Acc Go To Pos From Act Pos Starting With Dem Vel = 0 (0C4xh)

Name	Byte Offset	Description	Type	Unit
Header	0	0C4xh: VAI Dec=Acc Go To Pos From Act Pos Starting With Dem Vel =0	UInt16	-
1. Par	2	Target Position	SInt32	0.1 μm
2. Par	6	Maximal Velocity	UInt32	1E-6 m/s
3. Par	10	Acceleration = Deceleration	UInt32	1E-5 m/s ²

This command starts a new VAI setpoint generation from the actual position and the start velocity is forced to zero. Can be used after a press command.

4.3.110 VAI Dec=Acc Go To Pos With Max Curr (0C5xh)

Name	Byte Offset	Description	Type	Unit
Header	0	0C5xh: VAI Dec=Acc Go To Pos With Max Curr	UInt16	-
1. Par	2	Target Position	SInt32	0.1 μm
2. Par	6	Maximal Velocity	UInt32	1E-6 m/s
3. Par	10	Acceleration = Deceleration	UInt32	1E-5 m/s ²
4. Par	14	Demand Curr Limit	UInt16	1mA

This command can be used as press command with limited current (force). This command sets the maximal current of the actual position controller set (UPID 13A6h or 13BAh) to the value defined with the 4th parameter. To reset the current to the normal value, use the command 0C6xh or 0C7xh.

4.3.111 VAI Dec=Acc Go To Pos From Act Pos And Vel With Max Curr (0C6xh)

Name	Byte Offset	Description	Type	Unit
Header	0	0C6xh: VAI Dec=Acc Go To Pos From Act Pos And Vel With Max Curr	UInt16	-
1. Par	2	Target Position	SInt32	0.1 μm
2. Par	6	Maximal Velocity	UInt32	1E-6 m/s
3. Par	10	Acceleration = Deceleration	UInt32	1E-5 m/s ²
4. Par	14	Demand Curr Limit	UInt16	1mA

This command can be used after the command 0C5xh to set the current to the normal value. At the beginning of the motion the position controller integrator is cleared. This command sets the maximal current of the actual position controller set (UPID 13A6h or 13BAh) to the value defined with the 4th parameter.

4.3.112 VAI Dec=Acc Go To Pos From Act Pos And Vel = 0 With Max Curr (0C7xh)

Name	Byte Offset	Description	Type	Unit
Header	0	0C7xh: VAI Dec=Acc Go To Pos From Act Pos And	UInt16	-

		Vel = 0 With Max Curr		
1. Par	2	Target Position	SInt32	0.1 um
2. Par	6	Maximal Velocity	UInt32	1E-6 m/s
3. Par	10	Acceleration = Deceleration	UInt32	1E-5 m/s ²
4. Par	14	Demand Curr Limit	UInt16	1mA

This command can be used after the command 0C5xh to set the current to the normal value. At the beginning of the motion the position controller integrator is cleared. This command sets the maximal current of the actual position controller set (UPID 13A6h or 13BAh) to the value defined with the 4th parameter.

4.3.113 VAI Dec=Acc Go To Pos After Actual Command (0C8xh)

Name	Byte Offset	Description	Type	Unit
Header	0	0C8xh: VAI Dec=Acc Go To Pos After Actual Command	UInt16	-
1. Par	2	Target Position	SInt32	0.1 um
2. Par	6	Maximal Velocity	UInt32	1E-6 m/s
3. Par	10	Acceleration = Deceleration	UInt32	1E-5 m/s ²

This command waits until the actual motion setpoint generation has finished, then starts the new defined VAI motion.

4.3.114 VAI Dec=Acc Go To Pos On Rising Trigger Event (0CAxh)

Name	Byte Offset	Description	Type	Unit
Header	0	0CAxh: VAI Dec=Acc Go To Pos On Rising Trigger Event	UInt16	-
1. Par	2	Target Position	SInt32	0.1 um
2. Par	6	Maximal Velocity	UInt32	1E-6 m/s
3. Par	10	Acceleration = Deceleration	UInt32	1E-5 m/s ²

4.3.115 VAI Dec=Acc Increment Target Pos On Rising Trigger Event (0CBxh)

Name	Byte Offset	Description	Type	Unit
Header	0	0CBxh: VAI Dec=Acc Increment Target Pos On Rising Trigger Event	UInt16	-
1. Par	2	Position Increment	SInt32	0.1 um
2. Par	6	Maximal Velocity	UInt32	1E-6 m/s
3. Par	10	Acceleration = Deceleration	UInt32	1E-5 m/s ²

4.3.116 VAI Dec=Acc Go To Pos On Falling Trigger Event (0CCxh)

Name	Byte Offset	Description	Type	Unit
Header	0	0CCxh: VAI Dec=Acc Go To Pos On Falling Trigger Event	UInt16	-
1. Par	2	Target Position	SInt32	0.1 um
2. Par	6	Maximal Velocity	UInt32	1E-6 m/s
3. Par	10	Acceleration = Deceleration	UInt32	1E-5 m/s ²

4.3.117 VAI Dec=Acc Increment Target Pos On Falling Trigger Event (0CDxh)

Name	Byte Offset	Description	Type	Unit
Header	0	0CDxh: VAI Dec=Acc Increment Target Pos On Falling Trigger Event	UInt16	-
1. Par	2	Position Increment	SInt32	0.1 μ m
2. Par	6	Maximal Velocity	UInt32	1E-6 m/s
3. Par	10	Acceleration = Deceleration	UInt32	1E-5 m/s ²

4.3.118 VAI Increment Captured Pos (0D0xh)

Name	Byte Offset	Description	Type	Unit
Header	0	0D0xh: VAI Increment Captured Pos	UInt16	-
1. Par	2	Captured Position Increment	SInt32	0.1 μ m
2. Par	6	Maximal Velocity	UInt32	1E-6 m/s
3. Par	10	Acceleration	UInt32	1E-5 m/s ²
4. Par	14	Deceleration	UInt32	1E-5 m/s ²

Go to the target position (Captured Pos + Captured Increment Position).

4.3.119 VAI 16 Bit Dec=Acc Go To Pos (0D1xh)

Name	Byte Offset	Description	Type	Unit
Header	0	0D1xh: VAI 16 Bit Dec=Acc Go To Pos	UInt16	-
1. Par	2	Target Position	SInt16	Scaled
2. Par	4	Maximal Velocity	UInt16	Scaled
3. Par	6	Acceleration / Deceleration	UInt16	Scaled

4.3.120 VAI Go To Cmd Tab Var1 Pos (0D4xh)

Name	Byte Offset	Description	Type	Unit
Header	0	0D4xh: VAI Go To Cmd Tab Var1 Pos	UInt16	-
1. Par	2	Maximal Velocity	UInt32	1E-6 m/s
2. Par	6	Acceleration	UInt32	1E-5 m/s ²
3. Par	10	Deceleration	UInt32	1E-5 m/s ²

Go to the target position defined with the command table variable 1 (UPID 1E72h).

4.3.121 VAI Go To Cmd Tab Var2 Pos (0D5xh)

Name	Byte Offset	Description	Type	Unit
Header	0	0D5xh: VAI Go To Cmd Tab Var2 Pos	UInt16	-
1. Par	2	Maximal Velocity	UInt32	1E-6 m/s
2. Par	6	Acceleration	UInt32	1E-5 m/s ²
3. Par	10	Deceleration	UInt32	1E-5 m/s ²

Go to the target position defined with the command table variable 2 (UPID 1E73h).

4.3.122 VAI Go To Cmd Tab Var1 Pos From Act Pos And Act Vel (0D6xh)

Name	Byte Offset	Description	Type	Unit
Header	0	0D6xh: VAI Go To Cmd Tab Var1 Pos From Act Pos And Act Vel	UInt16	-
1. Par	2	Maximal Velocity	UInt32	1E-6 m/s
2. Par	6	Acceleration	UInt32	1E-5 m/s ²
3. Par	10	Deceleration	UInt32	1E-5 m/s ²

Go to the target position defined with the command table variable 1 (UPID 1E72h) starting from actual position and with actual velocity.

4.3.123 VAI Go To Cmd Tab Var2 Pos From Act Pos And Act Vel (0D7xh)

Name	Byte Offset	Description	Type	Unit
Header	0	0D7xh: VAI Go To Cmd Tab Var2 Pos From Act Pos And Act Vel	UInt16	-
1. Par	2	Maximal Velocity	UInt32	1E-6 m/s
2. Par	6	Acceleration	UInt32	1E-5 m/s ²
3. Par	10	Deceleration	UInt32	1E-5 m/s ²

Go to the target position defined with the command table Variable 2 (UPID 1E73h) starting from actual position and with actual velocity.

4.3.124 VAI Start Trig Rise Config VAI Command (0DExh)

Name	Byte Offset	Description	Type	Unit
Header	0	0DExh: VAI Start Trig Rise Config VAI Command	UInt16	-

This command starts the VAI motion command, defined with the parameters in Trig Rise Config of the Triggered VA-Interpolator Run Mode settings.

4.3.125 VAI Start Trig Rise Config VAI Command (0DFxh)

Name	Byte Offset	Description	Type	Unit
Header	0	0DFxh: VAI Start Trig Fall Config VAI Command	UInt16	-

This command starts the VAI motion command, defined with the parameters in Trig Fall Config of the Triggered VA-Interpolator Run Mode settings.

4.3.126 Encoder Cam Enable (100xh)

Name	Byte Offset	Description	Type	Unit
Header	0	100xh: Encoder CAM Enable	UInt16	-

4.3.127 Encoder Cam Disable (101xh)

Name	Byte Offset	Description	Type	Unit
Header	0	101xh: Encoder CAM Disable	UInt16	-

4.3.128 Encoder Cam Go To Sync Pos (102xh)

Name	Byte Offset	Description	Type	Unit
Header	0	102xh: Encoder CAM Go To Sync Pos	UInt16	-

4.3.129 Encoder Cam Set Value (104xh)

Name	Byte Offset	Description	Type	Unit
Header	0	104xh: Encoder CAM Set Value	UInt16	-
1. Par	2	Counter Value	SInt32	1 Incr.

4.3.130 Encoder Cam y Define Curve With Default Parameters (1y0xh)

At the moment two cams can be defined. In the following y=1 stands for cam 1 and y=2 stands for cam 2.

Name	Byte Offset	Description	Type	Unit
Header	0	1y0xh: Encoder Cam y Define Curve With Default Parameters (y=1..2)	UInt16	-
1. Par	2	Curve ID	UInt16	1..100
2. Par	4	Curve Start Count	SInt32	1 Incr.

4.3.131 Encoder Cam y Define Curve From Act Pos (1y1xh)

Name	Byte Offset	Description	Type	Unit
Header	0	1y1xh: Encoder Cam y Define Curve From Act Pos (y=1..2)	UInt16	-
1. Par	2	Curve ID	UInt16	1..100
2. Par	4	Curve Start Count	SInt32	1 Incr.

If the encoder value is in the range of cam y, the motor has to be at the start position of the cam y during the command setup, to set the position start point of cam y correctly.

4.3.132 Encoder Cam y Define Curve To Pos (1y2xh)

Name	Byte Offset	Description	Type	Unit
Header	0	1y2xh: Encoder Cam y Define Curve To Pos (y=1..2)	UInt16	-
1. Par	2	Curve ID	UInt16	1..100
2. Par	4	Curve Start Count	SInt32	1 Incr
3. Par	8	Target Position	SInt32	0.1 um

If the encoder value is in the range of cam y, the motor has to be at the start position of the cam y during command setup, to set the position start point correctly of cam y.

4.3.133 Encoder Cam y Define Curve From Pos To Pos In Counts (1y3xh)

Name	Byte Offset	Description	Type	Unit
Header	0	1y3xh: Encoder Cam y Define Curve To Pos (y=1..2)	UInt16	-

1. Par	2	Curve ID	UInt16	1..100
2. Par	4	Curve Start Count	SInt32	1 Incr
3. Par	8	Start Position	SInt32	0.1 um
4. Par	12	Target Position	SInt32	0.1 um
5. Par	16	CAM Length In Counts	SInt32	1 Incr

4.3.134 Encoder Cam y Define Curve To Pos In Counts (1y4xh)

Name	Byte Offset	Description	Type	Unit
Header	0	1y4xh: Encoder Cam y Define Curve To Pos (y=1..2)	UInt16	-
1. Par	2	Curve ID	UInt16	1..100
2. Par	4	Curve Start Count	SInt32	1 Incr
3. Par	8	Target Position	SInt32	0.1 um
4. Par	12	CAM Length In Counts	SInt32	1 Incr

If the encoder value is in the range of cam y, the motor has to be at the start position of the cam y during command setup, to set the position start point correctly of cam y.

4.3.135 Encoder Cam y Define Curve With Amplitude Scale In Counts (1y5xh)

Name	Byte Offset	Description	Type	Unit
Header	0	1y5xh: Encoder CAM y Define Curve To Pos (y=1..2)	UInt16	-
1. Par	2	Curve ID	UInt16	1..100
2. Par	4	Curve Start Count	SInt32	1 Incr
3. Par	8	Amplitude Scale	SInt16	0.1%
4. Par	10	CAM Length In Counts	SInt32	1 Incr.

The values for the amplitude scale and cam length are updated immediately, for this reason this command should only used outside the cam y (old and new) definition. For changing the amplitude scale and/or length during cam y is active, use the command 1y8xh instead.

4.3.136 Encoder Cam y Enable (1y6xh)

Name	Byte Offset	Description	Type	Unit
Header	0	1y6xh Encoder Cam y Enable; (y=1..2)	UInt16	-

4.3.137 Encoder Cam y Disable (1y7xh)

Name	Byte Offset	Description	Type	Unit
Header	0	1y7xh Encoder Cam y Disable; (y=1..2)	UInt16	-

4.3.138 Encoder Cam y Change Amplitude Scale and Length (1y8xh)

Name	Byte Offset	Description	Type	Unit
Header	0	1y8xh: Encoder Cam y Define Curve To Pos (y=1..2)	UInt16	-

1. Par	2	Amplitude Scale	Sint16	0.1%
2. Par	4	CAM Length In Counts	Sint32	1 Incr.

The new values for the amplitude scale and cam length are updated at next cam y start event.

4.3.139 Encoder Winding Start With Default Parameters (300xh)

Name	Byte Offset	Description	Type	Unit
Header	0	300xh: Encoder Winding Start With Default Parameters	UInt16	-

4.3.140 Encoder Winding Start With Default Parameters At Revolutions (301xh)

Name	Byte Offset	Description	Type	Unit
Header	0	301xh: Encoder Winding Start With Default Parameters At Revolutions	UInt16	-
1. Par	2	Revolution Counts To Start	SInt32	1 Rev

4.3.141 Start Command Table Command (200xh)

Name	Byte Offset	Description	Type	Unit
Header	0	200xh: Start Command Table Command	UInt16	-
1. Par	2	Command Table ID	UInt16	1..255

4.3.142 Start Command Table Command On Rising Trigger Event (201xh)

Name	Byte Offset	Description	Type	Unit
Header	0	201xh: Start Command Table Command On Rising Trigger Event	UInt16	-
1. Par	2	Command Table ID	UInt16	1..255

4.3.143 Start Command Table Command On Falling Trigger Event (202xh)

Name	Byte Offset	Description	Type	Unit
Header	0	202xh: Start Command Table Command On Falling Trigger Event	UInt16	-
1. Par	2	Command Table ID	UInt16	1..255

4.3.144 Modify Command Table 16 bit Parameter in RAM (208xh)

Name	Byte Offset	Description	Type	Unit
Header	0	208xh: Modify Command Table 16 bit Parameter in RAM	UInt16	-
1. Par	2	Command Table ID	UInt16	1..255
2. Par	4	Parameter Offset	UInt16	0..3Eh
3. Par	6	Parameter Value	Sint16	-

This command modifies a single 16 bit parameter of the specified command table entry with the specified offset to specified value. Within the command table entry the link ID has offset = 2 the motion command header has offset = 4 and the first motion command parameter has offset = 6.

4.3.145 Modify Command Table 32 bit Parameter in RAM (209xh)

Name	Byte Offset	Description	Type	Unit
Header	0	209xh: Modify Command Table 32 bit Parameter in RAM	UInt16	-
1. Par	2	Command Table ID	UInt16	1..255
2. Par	4	Parameter Offset	UInt16	0..3Eh
3. Par	6	Parameter Value	Sint16	-

This command modifies a single 32 bit parameter of the specified command table entry with the specified offset to specified value. Within the command table entry the link ID has offset = 2 the motion command header has offset = 4 and the first motion command parameter has offset = 6.

4.3.146 Wait Time (210xh)

Name	Byte Offset	Description	Type	Unit
Header	0	210xh: Wait Time	UInt16	-
1. Par	2	Time	UInt32	100us

Can be used in a linked command table sequence.

4.3.147 Wait Until Motion Finished (211xh)

Name	Byte Offset	Description	Type	Unit
Header	0	211xh: Wait Until Motion Finished	UInt16	-

Can be used in a linked command table sequence.

4.3.148 Wait Until In Target Position (212xh)

Name	Byte Offset	Description	Type	Unit
Header	0	212xh: Wait Until Motion Finished	UInt16	-

Can be used in a linked command table sequence.

4.3.149 Wait Until Rising Trigger Event (213xh)

Name	Byte Offset	Description	Type	Unit
Header	0	213xh: Wait Until Rising Trigger	UInt16	-

Can be used in a linked command table sequence.

4.3.150 Wait Until Falling Trigger Event (214xh)

Name	Byte Offset	Description	Type	Unit
Header	0	214xh: Wait Until Falling Trigger	UInt16	-

Can be used in a linked command table sequence.

4.3.151 Wait Until Demand Position Greater Than (220xh)

Name	Byte Offset	Description	Type	Unit
Header	0	220xh: Wait Until Demand Position Greater Than	UInt16	-
1. Par	2	Dem Pos Trig Level	SInt32	0.1 um

Can be used in a linked command table sequence.

4.3.152 Wait Until Demand Position Less Than (221xh)

Name	Byte Offset	Description	Type	Unit
Header	0	221xh: Wait Until Demand Position Less Than	UInt16	-
1. Par	2	Dem Pos Trig Level	SInt32	0.1 um

Can be used in a linked command table sequence.

4.3.153 Wait Until Actual Position Greater Than (222xh)

Name	Byte Offset	Description	Type	Unit
Header	0	222xh: Wait Until Actual Position Greater Than	UInt16	-
1. Par	2	Act Pos Trig Level	SInt32	0.1 um

Can be used in a linked command table sequence.

4.3.154 Wait Until Actual Position Less Than (223xh)

Name	Byte Offset	Description	Type	Unit
Header	0	223xh: Wait Until Actual Position Less Than	UInt16	-
1. Par	2	Act Pos Trig Level	SInt32	0.1 um

Can be used in a linked command table sequence.

4.3.155 Wait Until Difference Position Greater Than (224xh)

Name	Byte Offset	Description	Type	Unit
Header	0	224xh: Wait Until Difference Position Greater Than	UInt16	-
1. Par	2	Diff Pos Trig Level	SInt32	0.1 um

Can be used in a linked command table sequence.

4.3.156 Wait Until Difference Position Less Than (225xh)

Name	Byte Offset	Description	Type	Unit
Header	0	225xh: Wait Until Difference Position Less Than	UInt16	-
1. Par	2	Diff Pos Trig Level	SInt32	0.1 um

Can be used in a linked command table sequence.

4.3.157 Wait Until Difference Position Unsigned Greater Than (226xh)

Name	Byte Offset	Description	Type	Unit
Header	0	226xh: Wait Until Difference Position Unsigned Greater Than	UInt16	-
1. Par	2	Diff Pos Trig Level	SInt32	0.1 um

Can be used in a linked command table sequence.

4.3.158 Wait Until Difference Position Unsigned Less Than (227xh)

Name	Byte Offset	Description	Type	Unit
Header	0	227xh: Wait Until Difference Position Unsigned Less Than	UInt16	-
1. Par	2	Diff Pos Trig Level	SInt32	0.1 um

Can be used in a linked command table sequence.

4.3.159 Wait Until Demand Velocity Greater Than (228xh)

Name	Byte Offset	Description	Type	Unit
Header	0	228xh: Wait Until Demand Velocity Greater Than	UInt16	-
1. Par	2	Dem Vel Trig Level	SInt32	1E-6 m/s

Can be used in a linked command table sequence.

4.3.160 Wait Until Demand Velocity Less Than (229xh)

Name	Byte Offset	Description	Type	Unit
Header	0	229xh: Wait Until Demand Velocity Less Than	UInt16	-
1. Par	2	Dem Vel Trig Level	SInt32	1E-6 m/s

Can be used in a linked command table sequence.

4.3.161 Wait Until Actual Velocity Greater Than (22Axh)

Name	Byte Offset	Description	Type	Unit
Header	0	22Axh: Wait Until Actual Velocity Greater Than	UInt16	-
1. Par	2	Act Vel Trig Level	SInt32	1E-6 m/s

Can be used in linked command table sequence.

4.3.162 Wait Until Actual Velocity Less Than (22Bxh)

Name	Byte Offset	Description	Type	Unit
Header	0	22Bxh: Wait Until Actual Velocity Less Than	UInt16	-
1. Par	2	Act Vel Trig Level	SInt32	1E-6 m/s

Can be used in a linked command table sequence.

4.3.163 Wait Until Current Greater Than (22Exh)

Name	Byte Offset	Description	Type	Unit
Header	0	22Exh: Wait Until Current Greater Than	UInt16	-
1. Par	2	Dem Curr Vel Trig Level	Sint16	1mA

Can be used in linked command table sequence.

4.3.164 Wait Until Current Less Than (22Fhx)

Name	Byte Offset	Description	Type	Unit
Header	0	22Fhx: Wait Until Current Less Than	UInt16	-
1. Par	2	Dem Curr Trig Level	Sint16	1mA

Can be used in a linked command table sequence.

4.3.165 Set Cmd Table Var 1 To (240xh)

Name	Byte Offset	Description	Type	Unit
Header	0	240xh: Set Cmd Table Var 1 To	UInt16	-
1. Par	2	Set value	Sint32	-

4.3.166 Add To Cmd Table Var 1 (241xh)

Name	Byte Offset	Description	Type	Unit
Header	0	241xh: Add To Cmd Table Var 1	UInt16	-
1. Par	2	Add value	Sint32	-

4.3.167 Set Cmd Table Var 2 To (242xh)

Name	Byte Offset	Description	Type	Unit
Header	0	242xh: Set Cmd Table Var 2 To	UInt16	-
1. Par	2	Set value	Sint32	-

4.3.168 Add To Cmd Table Var 2 (243xh)

Name	Byte Offset	Description	Type	Unit
Header	0	243xh: Add To Cmd Table Var 2	UInt16	-
1. Par	2	Add value	Sint32	-

4.3.169 Write Cmd Table Var 1 To UPID RAM value (248xh)

Name	Byte Offset	Description	Type	Unit
Header	0	248xh: Write Cmd Table Var 1 To UPID RAM value	UInt16	-
1. Par	2	UPID (Unique Parameter ID)	UInt16	-

4.3.170 Write Cmd Table Var 2 To UPID RAM value (249xh)

Name	Byte Offset	Description	Type	Unit
Header	0	249xh: Write Cmd Table Var 2 To UPID RAM value	UInt16	-
1. Par	2	UPID (Unique Parameter ID)	UInt16	-

4.3.171 Write UPID RAM Value To Cmd Table Var 1 (24Cxh)

Name	Byte Offset	Description	Type	Unit
Header	0	24Cxh: Write UPID RAM value To Cmd Table Var 1	UInt16	-
1. Par	2	UPID (Unique Parameter ID)	UInt16	-

4.3.172 Write UPID RAM Value To Cmd Table Var 2 (24Dxh)

Name	Byte Offset	Description	Type	Unit
Header	0	24Dxh: Write UPID RAM value To Cmd Table Var 2	UInt16	-
1. Par	2	UPID (Unique Parameter ID)	UInt16	-

4.3.173 IF Cmd Table Var 1 Less Than (250xh)

Name	Byte Offset	Description	Type	Unit
Header	0	250xh: IF Cmd Table Var 1 Less Than	UInt16	-
1. Par	2	Condition Value	Sint32	-
2. Par	6	Command Table ID IF TRUE	UInt16	1..255
3. Par	8	Command Table ID IF FALSE	UInt16	1..255

4.3.174 IF Cmd Table Var 1 Greater Than (251xh)

Name	Byte Offset	Description	Type	Unit
Header	0	251xh: IF Cmd Table Var 1 Greater Than	UInt16	-
1. Par	2	Condition Value	Sint32	-
2. Par	6	Command Table ID IF TRUE	UInt16	1..255
3. Par	8	Command Table ID IF FALSE	UInt16	1..255

4.3.175 IF Cmd Table Var 1 Less Than (252xh)

Name	Byte Offset	Description	Type	Unit
Header	0	252xh: IF Cmd Table Var 1 Less Than	UInt16	-
1. Par	2	Condition Value	Sint32	-
2. Par	6	Command Table ID IF TRUE	UInt16	1..255
3. Par	8	Command Table ID IF FALSE	UInt16	1..255

4.3.176 IF Cmd Table Var 1 Greater Than (253xh)

Name	Byte Offset	Description	Type	Unit
Header	0	253xh: IF Cmd Table Var 1 Greater Than	UInt16	-
1. Par	2	Condition Value	Sint32	-
2. Par	6	Command Table ID IF TRUE	UInt16	1..255
3. Par	8	Command Table ID IF FALSE	UInt16	1..255

4.3.177 IF Demand Position Less Than (258xh)

Name	Byte Offset	Description	Type	Unit
Header	0	258xh: IF Demand Position Less Than	UInt16	-
1. Par	2	Condition Value	Sint32	-
2. Par	6	Command Table ID IF TRUE	UInt16	1..255

3. Par	8	Command Table ID IF FALSE	Uint16	1..255
--------	---	---------------------------	--------	--------

4.3.178 IF Demand Position Greater Than (259xh)

Name	Byte Offset	Description	Type	Unit
Header	0	259xh: IF Demand Position Greater Than	UInt16	-
1. Par	2	Condition Value	Sint32	-
2. Par	6	Command Table ID IF TRUE	Uint16	1..255
3. Par	8	Command Table ID IF FALSE	Uint16	1..255

4.3.179 IF Actual Position Less Than (25Axh)

Name	Byte Offset	Description	Type	Unit
Header	0	25Axh: IF Actual Position Less Than	UInt16	-
1. Par	2	Condition Value	Sint32	-
2. Par	6	Command Table ID IF TRUE	Uint16	1..255
3. Par	8	Command Table ID IF FALSE	Uint16	1..255

4.3.180 IF Actual Position Greater Than (25Bxh)

Name	Byte Offset	Description	Type	Unit
Header	0	25Bxh: IF Actual Position Greater Than	UInt16	-
1. Par	2	Condition Value	Sint32	-
2. Par	6	Command Table ID IF TRUE	Uint16	1..255
3. Par	8	Command Table ID IF FALSE	Uint16	1..255

4.3.181 IF Difference Position Less Than (25Cxh)

Name	Byte Offset	Description	Type	Unit
Header	0	25Cxh: IF Difference Position Less Than	UInt16	-
1. Par	2	Condition Value	Sint32	-
2. Par	6	Command Table ID IF TRUE	Uint16	1..255
3. Par	8	Command Table ID IF FALSE	Uint16	1..255

4.3.182 IF Difference Position Greater Than (25Dxh)

Name	Byte Offset	Description	Type	Unit
Header	0	25Dxh: IF Difference Position Greater Than	UInt16	-
1. Par	2	Condition Value	Sint32	-
2. Par	6	Command Table ID IF TRUE	Uint16	1..255
3. Par	8	Command Table ID IF FALSE	Uint16	1..255

4.3.183 IF Current Less Than (25Exh)

Name	Byte Offset	Description	Type	Unit
Header	0	25Exh: IF Current Less Than	UInt16	-
1. Par	2	Condition Value	Sint32	-
2. Par	6	Command Table ID IF TRUE	Uint16	1..255
3. Par	8	Command Table ID IF FALSE	Uint16	1..255

4.3.184 IF Current Greater Than (25Fhx)

Name	Byte Offset	Description	Type	Unit
Header	0	25Fhx: IF Current Greater Than	UInt16	-
1. Par	2	Condition Value	Sint32	-
2. Par	6	Command Table ID IF TRUE	UInt16	1..255
3. Par	8	Command Table ID IF FALSE	UInt16	1..255

4.3.185 IF Analog Val On X4.4 Less Than (260xh)

Name	Byte Offset	Description	Type	Unit
Header	0	260xh: IF Analog Val On X4.4 Less Than	UInt16	-
1. Par	2	Condition Value	Sint32	-
2. Par	6	Command Table ID IF TRUE	UInt16	1..255
3. Par	8	Command Table ID IF FALSE	UInt16	1..255

4.3.186 IF Masked X4 Input Value Equal Than (262xh)

Name	Byte Offset	Description	Type	Unit
Header	0	262xh: IF Masked X4 Input Value Equal Than	UInt16	-
1. Par	2	X4 Bit Mask	UInt16	
2. Par	4	Condition Value	UInt16	-
3. Par	6	Command Table ID IF TRUE	UInt16	1..255
4. Par	8	Command Table ID IF FALSE	UInt16	1..255

4.3.187 IF Masked X6 Input Value Equal Than (263xh)

Name	Byte Offset	Description	Type	Unit
Header	0	263xh: IF Masked X6 Input Value Equal Than	UInt16	-
1. Par	2	X6 Bit Mask	UInt16	
2. Par	4	Condition Value	UInt16	-
3. Par	6	Command Table ID IF TRUE	UInt16	1..255
4. Par	8	Command Table ID IF FALSE	UInt16	1..255

4.3.188 IF Masked Status Word Equal Than (264xh)

Name	Byte Offset	Description	Type	Unit
Header	0	264xh IF Masked Status Word Equal Than	UInt16	-
1. Par	2	Status Word Bit Mask	UInt16	
2. Par	4	Condition Value	UInt16	-
3. Par	6	Command Table ID IF TRUE	UInt16	1..255
4. Par	8	Command Table ID IF FALSE	UInt16	1..255

4.3.189 IF Masked Warn Word Equal Than (265xh)

Name	Byte Offset	Description	Type	Unit
Header	0	265xh IF Masked Warn Word Equal Than	UInt16	-
1. Par	2	Warn Word Bit Mask	UInt16	

2. Par	4	Condition Value	UInt16	-
3. Par	6	Command Table ID IF TRUE	UInt16	1..255
4. Par	8	Command Table ID IF FALSE	UInt16	1..255

4.3.190 Encoder Winding Stop Adaptation Of Left/Right Position and Disturbance (304xh)

Name	Byte Offset	Description	Type	Unit
Header	0	304xh: Encoder Winding Stop Adaptation Of Left/Right Position And Disturbance.	UInt16	-

4.3.191 Encoder Winding Restart Adaptation Of Left/Right Position and Disturbance (305xh)

Name	Byte Offset	Description	Type	Unit
Header	0	305xh: Encoder Winding Restart Adaptation Of Left/Right Position And Disturbance	UInt16	-

4.3.192 Encoder Curve Winding Start With Default Parameters (310xh)

Name	Byte Offset	Description	Type	Unit
Header	0	310xh: Encoder Curve Winding Start With Default Parameters	UInt16	-
1. Par	2	Curve ID	UInt16	1..100

4.3.193 Encoder Curve Winding Start With Default Parameters At Revolutions (311xh)

Name	Byte Offset	Description	Type	Unit
Header	0	311xh: Encoder Curve Winding Start With Default Parameters At Revolutions	UInt16	-
1. Par	2	Curve ID	UInt16	1..100
2. Par	4	Revolution Counts To Start	SInt32	1 Rev

4.3.194 VAI Go To Pos With Higher Force Ctrl Limit (380xh)

Name	Byte Offset	Description	Type	Unit
Header	0	380xh: VAI Go To Pos With Higher Force Ctrl Limit	UInt16	-
1. Par	2	Target Position	SInt32	0.1 um
2. Par	6	Maximal Velocity	UInt32	1E-6 m/s
3. Par	10	Acceleration	UInt32	1E-5 m/s ²
4. Par	14	Force Limit	SInt16	0.1 N

Moves to the defined target position, if the measured force reaches the higher defined value the drive switches to the force control mode with target force = force limit.

To change back to position control mode use motion command VAI Go To Pos From Act Pos And Reset Force Control (381xh).

4.3.195 VAI Go To Pos From Act Pos And Reset Force Control (381xh)

Name	Byte Offset	Description	Type	Unit
Header	0	381xh: VAI Go To Pos From Act Pos And Reset Force Control	UInt16	-
1. Par	2	Target Position	SInt32	0.1 μm
2. Par	6	Maximal Velocity	UInt32	1E-6 m/s
3. Par	10	Acceleration	UInt32	1E-5 m/s ²
4. Par	14	Deceleration	UInt32	1E-5 m/s ²

Reinstalls the position control mode and moves to the defined target position.

4.3.196 Force Ctrl Change Target Force (382xh)

Name	Byte Offset	Description	Type	Unit
Header	0	382xh: Force Ctrl Change Target Force	UInt16	-
1. Par	2	Target Force	Sint16	0.1 N

This command can be used to change the target force during the force control mode.

4.3.197 VAI Go To Pos With Higher Force Ctrl Limit and Target Force (383xh)

Name	Byte Offset	Description	Type	Unit
Header	0	383xh: VAI Go To Pos With Higher Force Ctrl Limit and Target Force	UInt16	-
1. Par	2	Target Position	Sint32	0.1 μm
2. Par	6	Maximal Velocity	UInt32	1E-6 m/s
3. Par	10	Acceleration	UInt32	1E-5 m/s ²
4. Par	14	Force Limit	Sint16	0.1 N
5. Par	16	Target Force	Sint16	0.1 N

Moves to the defined target position, if the measured force reaches the higher force limit the drive switches to the force control mode with target force = target force.

To change back to position control mode use motion command VAI Go To Pos From Act Pos And Reset Force Control (381xh).

4.3.198 VAI Go To Pos With Lower Force Ctrl Limit (384xh)

Name	Byte Offset	Description	Type	Unit
Header	0	384xh: VAI Go To Pos With Lower Force Ctrl Limit	UInt16	-
1. Par	2	Target Position	SInt32	0.1 μm
2. Par	6	Maximal Velocity	UInt32	1E-6 m/s
3. Par	10	Acceleration	UInt32	1E-5 m/s ²
4. Par	14	Force Limit	Sint16	0.1 N

Moves to the defined target position, if the measured force reaches the lower defined value the drive switches to the force control mode with target force = force limit.

To change back to position control mode use motion command VAI Go To Pos From Act Pos And Reset Force Control (381xh).

4.3.199 VAI Go To Pos With Lower Force Ctrl Limit and Target Force (385xh)

Name	Byte Offset	Description	Type	Unit
Header	0	385xh: VAI Go To Pos With Lower Force Ctrl Limit and Target Force	UInt16	-
1. Par	2	Target Position	Sint32	0.1 μ m
2. Par	6	Maximal Velocity	UInt32	1E-6 m/s
3. Par	10	Acceleration	UInt32	1E-5 m/s ²
4. Par	14	Force Limit	Sint16	0.1 N
5. Par	16	Target Force	Sint16	0.1 N

Moves to the defined target position, if the measured force reaches the lower force limit the drive switches to the force control mode with target force = target force.

To change back to position control mode use motion command VAI Go To Pos From Act Pos And Reset Force Control (381xh).

5 Setpoint Generation

5.1 VA-Interpolator

The VA-Interpolator generates a position curve from one position to another due to the parameter values of acceleration deceleration and a maximal speed. A new target position can be set even if the old target position was not reached.

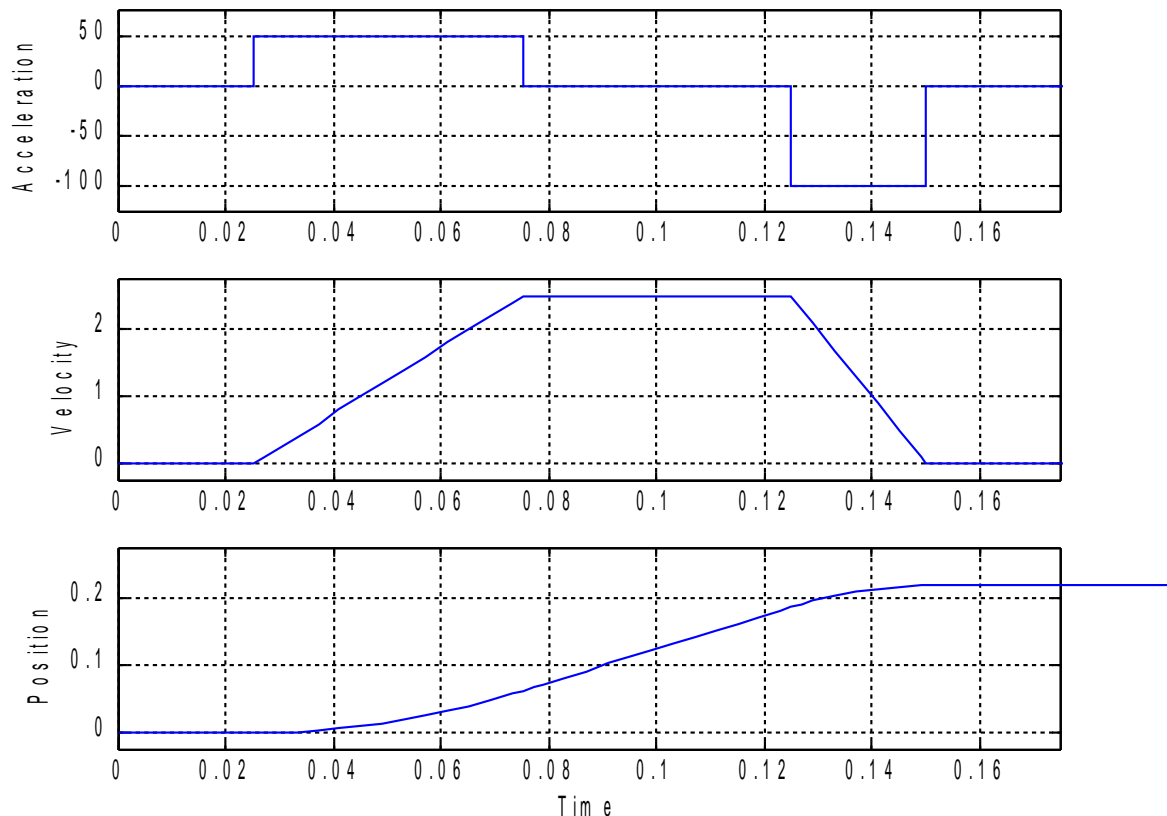

5.1.1.1 Parameters and Output

The VA-Interpolator is defined by the following parameters:

- Target Position [SInt32; 0.1um/s]
- Maximal Speed [UInt32; 1E-6 m/s]
- Acceleration [UInt32; 1E-5 m/s²]
- Deceleration [UInt32; 1E-5 m/s²]

The VA-Interpolator generates as outputs:

- Position [SInt32; 0.1um]
- Velocity [SInt32; 1E-6 m/s]
- Acceleration [SInt32; 1E-5 m/s²]

5.2 P(V)-Stream

For masters with NC (Numerical Control) capabilities, the software supports cyclic streaming modes of the position and velocity, or position only. The streaming has to be strictly cyclic in the period range 2ms to 5ms. This feature is supported with all fieldbus variants like Profibus DP, CAN Open¹, POWERLINK, EtherCAT,

Different modes are supported:

In the first mode (Motion command: 030xh) the master only streams the position.

In the second mode (Motion command: 031xh) the master streams position and velocity, whenever possible use the PV-streaming mode, because the acceleration derivation is less sensitive to bus jitters than in the position only streaming mode.

The third mode (Motion command: 032xh) is like the first mode, but for the derivation of the velocity and the acceleration a configured period time (UPID 14E6h) is taken, instead of the slave receive time stamp. This minimizes the bad influence of the transmission jitter.

The position setpoint generation in these modes is delayed 1.5 times the streaming cycle time, e.g. with 2ms streaming period time the delay is 3ms.

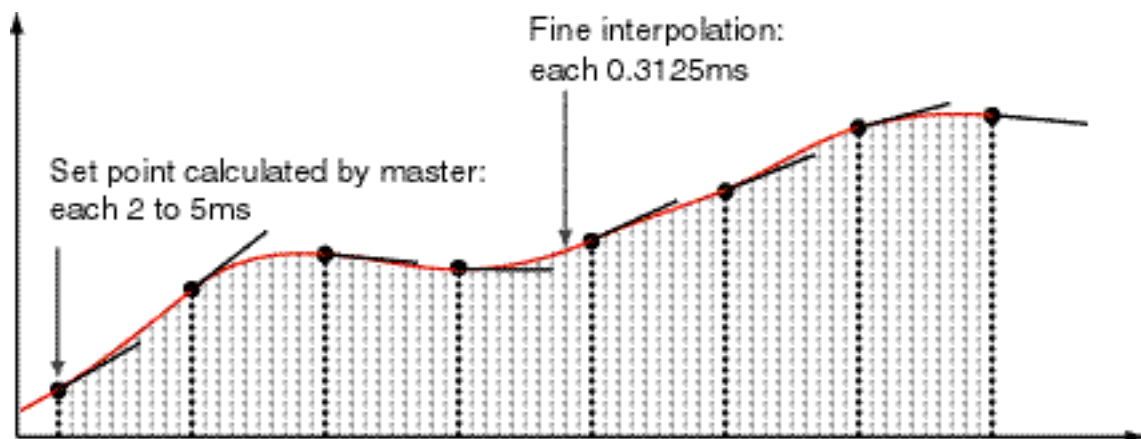

In the P- streaming mode, it is possible that, depending on the cycle time, a quiet noisy motion is generated, this because of the twice derivation of the position signal to generate the acceleration value. In this case, it is recommended to set the position controller value "FF Acceleration" (UPID 0x13A0 and 0x13B4) to zero.

¹ P(V)-Streaming with CANOpen is only possible with transmission type 1 (synchronous transmission)

5.3 Cam Motions

NOTE: Cam motions are not available in the B1100 drives.

For high speed synchronization different modes of cam motions are supported. The motions are defined with cam curves, which can be defined with the curve tool of the LinMot-Talk software.

5.3.1 Triggered Cam Motions

For triggered cam motions setup the master encoder and then set cam mode (UPID1527h) to infinite length. Then use the motion commands 069xh or 06Bxh to setup the cam curves which should be started at the trigger event, or use the triggered cam curve run mode.

5.3.2 Repeated Cam Motions with the Modulo CamMode

For repeated cam motions setup the master encoder and then set cam mode (UPID1527h) to modulo cam length. The cam length can be defined independently from the master encoder length! So with a 8000 counts ABZ master encoder also 16'000 counts or 4'000 counts cam length is possible.

With the following sequence a startup or resynchronization to a standing master encoder is possible:

- Move to start position of cam 1 motion e.g. VAI GoTo Pos (010xh)
- Define cam 1 motion e.g. Encoder CAM 1 Define Curve To Pos (112xh)
- Move to start position of cam 2 motion e.g. VAI GoTo Pos (010xh)
- Define cam 2 motion e.g. Encoder CAM 2 Define Curve To Pos (112xh)
- Go to synchronized cam position with (102xh)
- After synchronized cam position is reached enable cam motion with (100xh)
- Start turning the encoder

With the following sequence a (re)synchronization to a moving master encoder is possible:

- Disable cam start enable (UPID 1528h) and wait until cam enabled vanishes, or clear also cam enabled (1BA9h)
- Move to start position of cam 1 motion e.g. VAI GoTo Pos (010xh)
- Define cam 1 motion e.g. Encoder CAM 1 Define Curve To Pos (112xh)
- Define cam 2 motion e.g. Encoder CAM 2 Define Curve To Pos (112xh)
- After the synchronized cam position is reached, enable the cam motion with (100xh)
- Enable cam start enable (UPID 1528h)

5.4 Winding

NOTE: Winding is not available in the B1100 drives.

Winding applications are supported with specific position setpoint functionality. Several parameters define the behavior of the setpoint generation and the shape of the resulting bobbin. The encoder has to be set to AB modulo mode (ABZ mode planned, but not implemented yet).

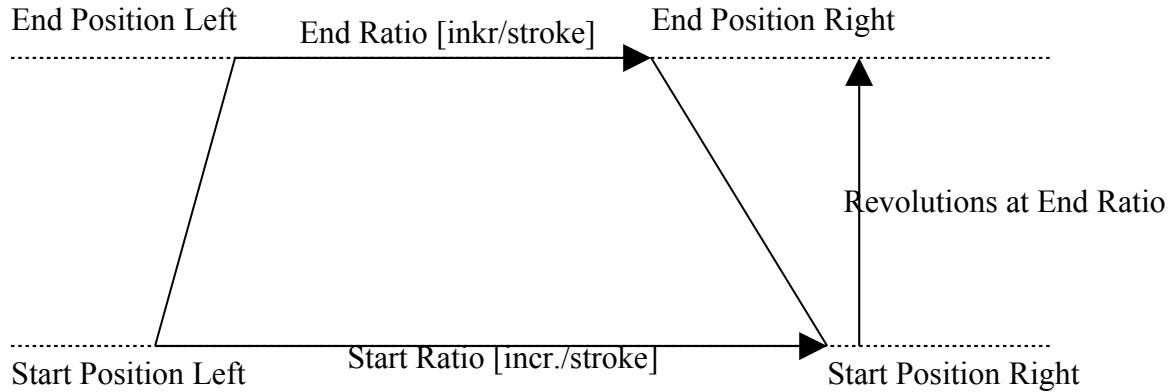

5.4.1 Winding disturbance

To avoid 'dog bones' on bobbins an additional disturbance can be added. The left and right end position of the stroke will be distributed within a definable range and pattern.

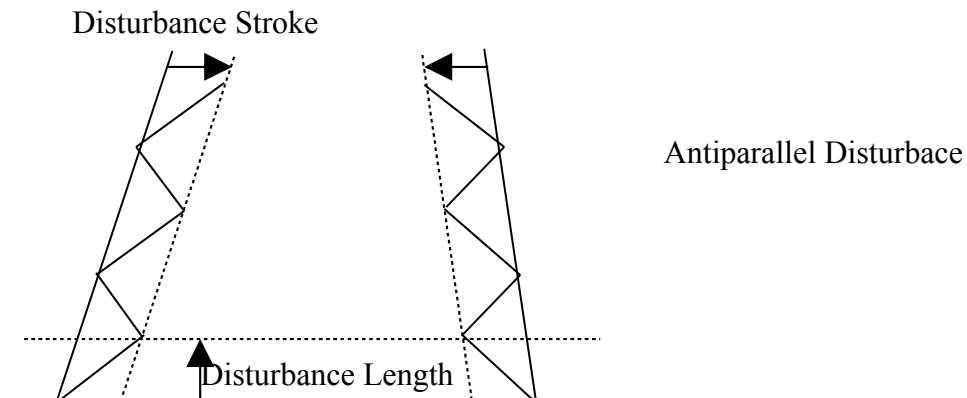
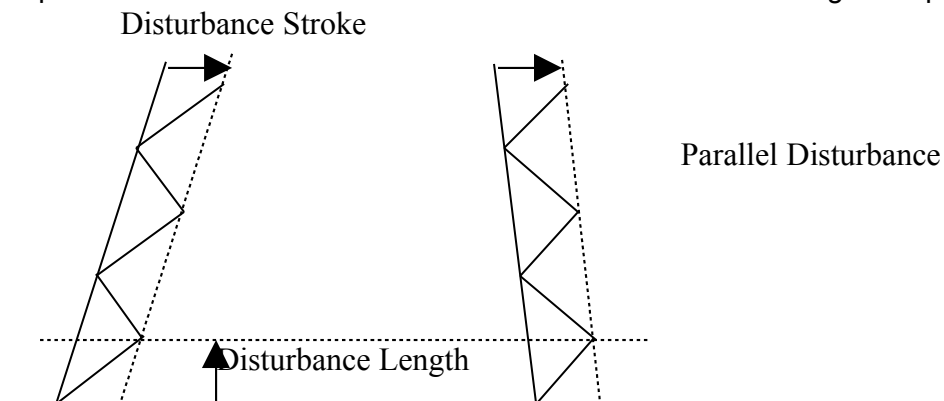

6 Command Table

NOTE: The command table in the B1100 drives is limited to 31 entries, and is flash only, for this reason it is not possible to write or modify the table over a serial interface!

The command table functionality can be used for programming sequences directly in the drive. The following examples illustrate the possibilities of the command table. The shown command table can be loaded from the defaults 'CT_Example.lmc'.

ID	Name	Type	Par 1	Par 2	Par 3	Par 4	Sequenced Entry
1	Go To 50mm	VAI Go To Pos	Pos: 50 mm	Vel: 0.5 m/s	Acc: 2 m/s ²	Dec: 1 m/s ²	2 (Wait Motion ...)
2	Wait Motion Done	Wait until Motion Finished					3 (Go To 0 mm)
3	Go To 0 mm	VAI Go To Pos	Pos: 0 mm	Vel: 1 m/s	Acc: 10 m/s ²	Dec: 10 m/s ²	None
4							
5	Reset CT Var1	Set Cmd Table Var 1 To	Set Val: 0				6 (Go To 50mm)
6	Go To 50mm	VAI Go To Pos	Pos: 50 mm	Vel: 1 m/s	Acc: 10 m/s ²	Dec: 10 m/s ²	7 (Wait In Pos)
7	Wait In Pos	Wait until In Target Position					8 (Go To 0 mm)
8	Go To 0 mm	VAI Go To Pos	Pos: 0 mm	Vel: 1 m/s	Acc: 10 m/s ²	Dec: 10 m/s ²	9 (Wait Motion ...)
9	Wait Motion Done	Wait until Motion Finished					10 (Inc CT Var1)
10	Inc CT Var1	Add To Cmd Table Var 1	Add Val: 1				11 (IF Var1 < 5)
11	IF Var1 < 5	IF Cmd Table Var 1 Less Than	Val 5	True Cmd ID: 6 (...)	False Cmd ID: 12...		None
12	End Seq	No Operation					None
13							
14	Reduce Force	Write Live Parameter	UPID: 13A6h (M...	Value: 1 A			15 (Go To 50mm)
15	Go To 50mm	VAI Go To Pos	Pos: 50 mm	Vel: 0.05 m/s	Acc: 1 m/s ²	Dec: 1 m/s ²	16 (Wait Motion ...)
16	Wait Motion Done	Wait until Motion Finished					17 (Test For Part)
17	Test For Part	IF Actual Position Less Than	Val: 48 mm	True Cmd ID: 18...	False Cmd ID: 21...		None
18	Go To 0 mm	VAI Go To Pos	Pos: 0 mm	Vel: 1 m/s	Acc: 10 m/s ²	Dec: 10 m/s ²	19 (Set Normal F...
19	Set Normal Force	Write Live Parameter	UPID: 13A6h (M...	Value: 4 A			20 (CT Var1 = 0)
20	CT Var1 = 0	Set Cmd Table Var 1 To	Set Val: 0				None
21	Go To 0 mm	VAI Go To Pos	Pos: 0 mm	Vel: 1 m/s	Acc: 10 m/s ²	Dec: 10 m/s ²	22 (Set Normal F...
22	Set Normal Force	Write Live Parameter	UPID: 13A6h (M...	Value: 4 A			23 (CT Var1 = 1)
23	CT Var1 = 1	Set Cmd Table Var 1 To	Set Val: 1				None
24							
25							

The first sequence ID1, ID2 and ID3 shows a simple sequence GoTo 50mm wait until motion is completed and then go back to 0mm.

The second sequence ID5..12 repeats 5 times the Sequence GoTo 50mm GoTo 0mm

1. ID 5: Set Command Table To Var 1 = 0
2. ID 6: GoTo 50mm
3. ID 7: Wait Until In Target Position
4. ID 8: GoTo 0mm
5. ID 9: Wait until Motion Done
6. ID 10: Increment Command Table Var 1
7. ID 11: If Command Table To Var 1 < 5 Then GoTo ID 6 Else GoTo ID 12
8. ID 12: No Operation End of Sequence

The third sequence ID14..23 changes the maximal current of the position controller set A (UPID 13A6), goes to 50mm wait until motion completed, tests if part is present (Act Pos < 48), goes back to 0mm, sets Normal Force (Current) and sets CT Var 1 = 0 if part was present else set CT Var1 = 1.

7 Drive Configuration

The parameter configuration is normally done with Lintalk1100-SW [3]. The UPIDs, over which the parameter can be accessed, are different for the B1100 drives. In this documentation the E1100 UPIDs are used. If a UPID for a B1100 drive is needed, a conversion list can be generated with the Lintalk1100-SW.

7.1 Power Bridge

The E1100/B1100 drives are divided into three different power classes. The normal drives have a maximal current of 8A, the high current (name extension HC) variant has a maximal current of 15A and the extreme current (name extension XC) has a maximal current of 25A.

7.2 X4 I/O Definitions

The functionality of most IOs can be programmed as a control word input bit or status word output bit, or they can be used as interface IO and read out or written over a serial bus interface. Apart from this general functionality a few IOs have a special functionality.

Descriptor	General Purpose IO	Special Functions
X4.3	Yes	Brake (Output)
X4.4	Yes	Analog In
X4.5	Yes	Capture Input
X4.6	Yes	Trigger (Input)
X4.7	Yes	Home Switch (Input)
X4.8	Yes	Limit IN (Input)
X4.9	Yes	Limit OUT (Input) / 24V Step (Input)
X4.10	Yes	PTC 1 (Input) / 24V Direction (Input)
X4.11	Yes	PTC 2 (Input)
X4.12	No	SVE Safety Voltage Enable (Input)

7.2.1 X4.3 Brake

The output X4.3 can drive up to 1A, so it can be used to control directly a valve of a pneumatic brake module. For this reason this output can be configured as brake output. The cases in which the brake has to be applied or released are configured over the brake mode parameters. The brake output is controlled from the state machine.

Parameter Name	UPID	Description
Status Word: Operation Enabled	1717h	The brake is released (X4.3 = 24V), when bit 0 of the status word (Operation Enabled) is set. Otherwise the brake is applied.
Ctrl Word: /Abort	1718h	The brake is applied (X4.3 = 0V) when entering the Aborting State (12) and released (X4.3 = 24V) when going to Operation Enabled State (8) again.
Quick Stop	1716h	Special brake behavior with Quick Stop (Brake Mode Status Word: Operation Enabled has also to be set)

7.2.1.1 X4.3 Brake Operation Enabled Behavior

The following figure shows the behavior when only the brake mode “Status Word: Operation Enabled” is selected. If only this switch (with UPID 1717h) is activated, no apply or release delay time is regarded.

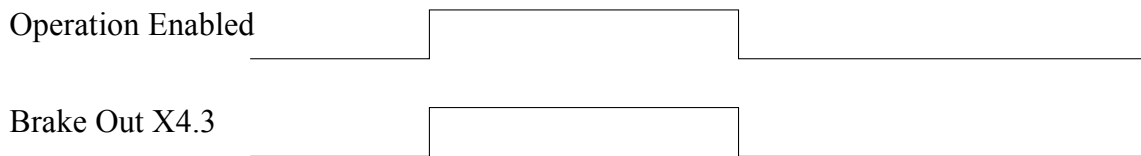

7.2.1.2 X4.3 Brake Operation /Abort Behavior

When set the brake mode to “Ctrl Word: /Abort”, the brake is applied in state Aborting (12) and the maximal current of the motor is set to 0A. If using this behavior, ensure that the maximal current (UPID 13A6h and 13BAh) is not set over a serial bus during the state Aborting (12)!

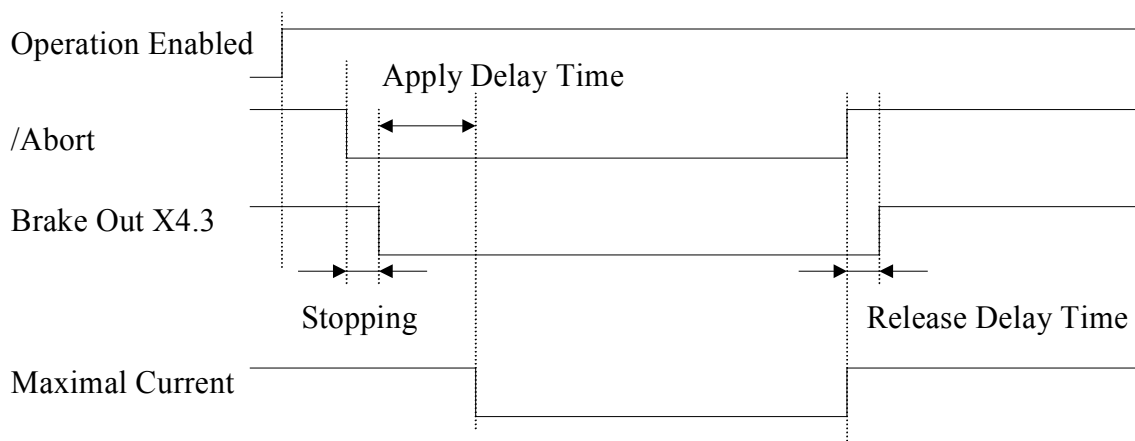

Parameter Name	UPID	Description
Apply Delay Time	171Bh	Delay time after brake output goes to 0V until the maximal current of the motor is set to 0A (UPID 13A6h and 13BAh).
Release Delay Time	171Ch	Delay time of the Status Word bit: Operation Enabled after the motion has stopped.

7.2.1.3 X4.3 Brake Operation Quick Stop Behavior

If also the Quick Stop brake behavior is selected the brake is applied (X4.3 = 0V) as soon as the motion has stopped, then the reset of the Operation Enabled bit is delayed by the apply delay time, which then also powers off the motor.

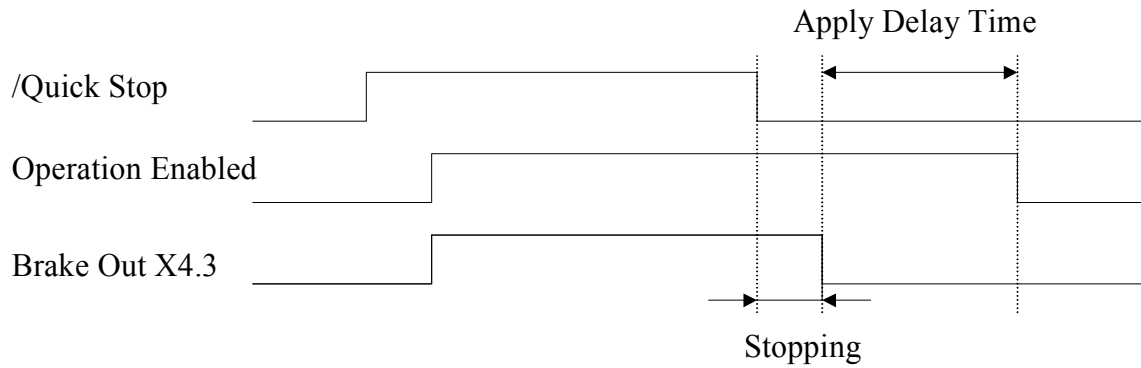

Parameter Name	UPID	Description
Apply Delay Time	171Bh	Delay time of the Status Word bit: Operation Enabled after the motion has stopped.

7.2.2 X4.6 Trigger

For the trigger input, which is evaluated in the motion control task, different evaluation modes are supported.

Parameter Name	UPID	Description
Trigger Modes	170Ch	Trigger mode selection: <ul style="list-style-type: none"> • 0: None • 1: Direct • 2: Inhibited • 3: Delayed • 4: Inhibited & Delayed

7.2.2.1 Direct Trigger Mode

In the Direct Trigger Mode copies the trigger input directly copied to the trigger output, which is used by the MC-SW. No parameter configuration is needed for this mode.

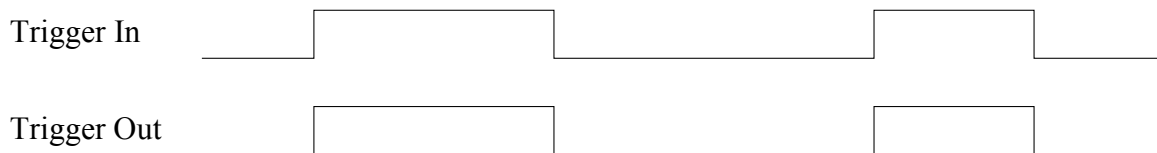

7.2.2.2 Inhibited Trigger Mode

The Inhibit Trigger Mode can be used to debounce a jittering trigger input without delay. This method doesn't increase the noise immunity!

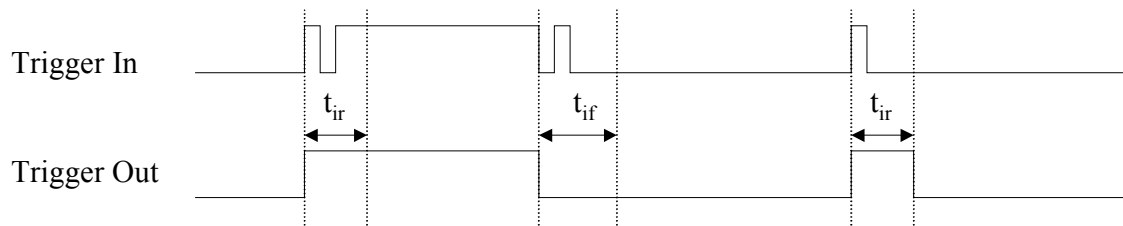

Parameter Name	UPID	Description
Rise Inhibit Time	170Dh	Inhibit time after rising edge of trigger in signal (t_{ir})
Fall Inhibit Time	170Eh	Inhibit time after falling edge of trigger in signal (t_{if})

7.2.2.3 Delayed Trigger Mode

The Delayed Trigger Mode can be used to delay an action following the rising or falling trigger event.

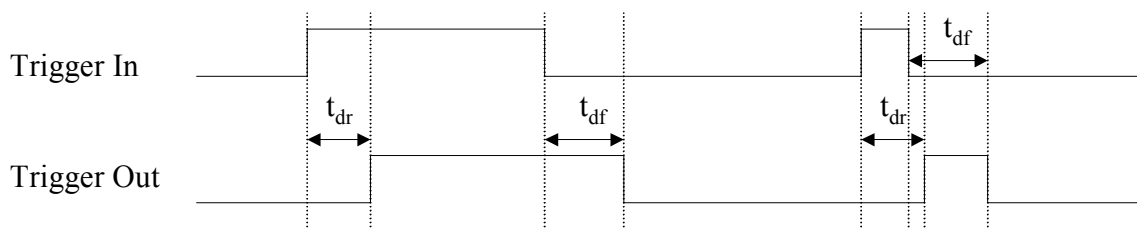

Parameter Name	UPID	Description
Rise Delay Time	170Fh	Trigger Out delay time after rising edge of Trigger In signal (t_{dr})
Fall Delay Time	1710h	Trigger Out delay time after falling edge of Trigger In signal (t_{df})

7.2.2.4 Inhibited & Delayed Trigger Mode

The Inhibited & Delayed Trigger Mode first debounces the trigger input signal with the inhibit time. The inhibited trigger signal is then delayed with the rise/fall delay time and then copied to the trigger out signal.

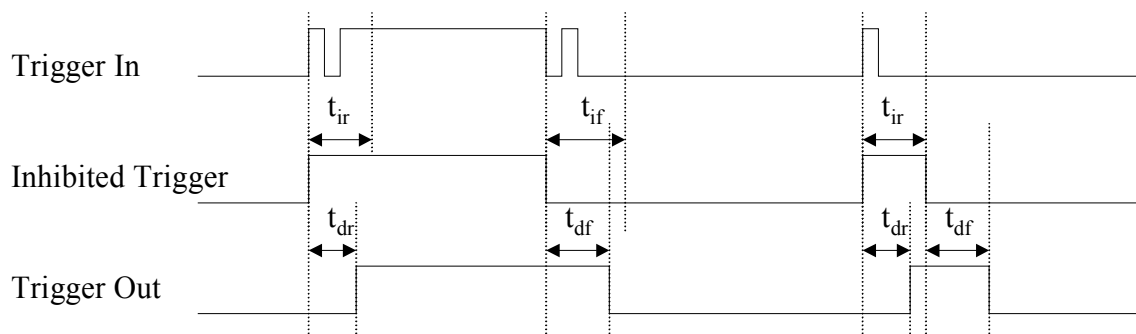

Parameter Name	UPID	Description
Rise Inhibit Time	170Dh	Inhibit time after rising edge of Trigger In signal (t_{ir})
Fall Inhibit Time	170Eh	Inhibit time after falling edge of Trigger In signal (t_{if})
Rise Delay Time	170Fh	Trigger Out Delay time after rising edge of Trigger In signal (t_{dr})
Fall Delay Time	1710h	Trigger Out Delay time after falling edge of Trigger In signal (t_{df})

7.2.3 X4.8 and X4.9 Limit Switches

If on IO pin X4.8 and/or on X4.9 a limit switch is defined, the error behavior in case of an active limit switch can be configured. The error is only generated on a powered motor which is homed, so it is possible to exit the error state with a new homing request. For that reason also the homed bit in the status word is cleared if moving into a limit switch.

Parameter Name	UPID	Description
Error Behavior	121Bh	Error behavior of the configured limit switches: <ul style="list-style-type: none"> • 0: No Error (maybe only used for homing) • 1: Power Off • 2: Quick Stop

7.2.4 X4.10 and X4.11 PTC 1 and PTC 2

On IO pins X4.10 and X4.11 PTC sensors can be connected to supervise an over temperature of a motor and/or the transformer supply. The other side of the PTC has to be connected to 24V. If the resistance is below 2kOhm the input is high. If it rises above 15kOhm the output is regarded as low. Typically, the transition low to high is between 5kOhm and 7kOhm. If the input rises, the corresponding bit in the warn word will be set after the PTC Warn Time. After the PTC error time the corresponding error is set. The error only can be acknowledged if the corresponding PTC warn bit has vanished.

7.2.5 X4.12 SVE (Safety Voltage Enable)

X4.12 is a special input (input only). If it goes low for more than 0.5ms the PWM generation of the power stage is disabled by hardware. Additionally, this bit is mapped directly to the Control Word bit 1. To disable this feature, the input must be wired to 24V logic supply.

7.3 Master Encoder

The master encoder can be used for applications where high-speed synchronization is needed, such as winding application, indexing positioning mode, etc.

The parameter Encoder Source defines whether the master encoder is connected to the X10 (RJ45) or the X12 (DSUB 9) connector. X10 is looped through to the master encoder connector X11 (RJ45). This simplifies the loop through cabling of the encoder signals.

Parameter Name	UPID	Description
Encoder Source	172Ah	Defines the source of the Master Encoder: <ul style="list-style-type: none">• 0: None• 1: Encoder Input X10• 2: Ext Sensor Input X12

The encoder type parameter defines the signal type of the master encoder. At any rate the signals have to be differential RS422. When using a SD(Z) master encoder, the step signal has to be connected to A, /A, Dir signal to B, /B and the Zero to Z, /Z.

Parameter Name	UPID	Description
Encoder Type	128Eh	Defines the Master Encoder Type: <ul style="list-style-type: none">• 0: None• 1: ABZ• 2: AB• 4: Step Dir (SD)• 5: Step Dir Zero (SDZ)

The decoding parameter defines how many edges of the signals are evaluated. For AB(Z) encoder types 1x, 2x, 4x decoding is valid; for SD(Z) encoder types only 1x and 2x decoding is valid. If 4x decoding is selected a 2x decoding is forced without error generation.

Parameter Name	UPID	Description
Decoding	128Fh	Defines the Master Encoder decoding: <ul style="list-style-type: none">• 0: 1x• 1: 2x• 2: 4x

With the direction parameter the count direction of the encoder evaluation can be defined.

Parameter Name	UPID	Description
Direction	1290h	Defines the Master Encoder direction: <ul style="list-style-type: none">• 0: Positive• 1: Negative

The Counts/Revolution parameter defines the number of counts per revolution for ABZ or SDZ master encoders.

Parameter Name	UPID	Description
Counts/ Revolution	1291h	Only used for ABZ or SDZ encoders, to define the counts per revolution.

The Speed Filter Time parameter defines the time over which the master encoder speed is calculated. Bigger values generate a smoother master encoder speed but generate a bigger delay time of the speed, which may be a problem if the master encoder speed varies quickly.

Parameter Name	UPID	Description
Speed Filter Time	1293h	Time over which the Master Encoder speed is generated.

7.4 Monitoring

All drive series support enhanced monitoring features of the supply voltages and the board temperatures.

7.4.1 Logic Supply Voltage

The logic supply voltage must be in the range from 20V to 28V when using the default parameter settings. If the supply voltage goes out of this range, an error will be generated. If the supply voltage goes below approx. 18V the drive shuts down.

Parameter Name	UPID	Description
Logic Supply Voltage Too Low	100Eh	If the logic supply voltage sinks below this limit the error 01h will be generated.

Parameter Name	UPID	Description
Logic Supply Voltage Too High	1010h	If the logic supply voltage rises above this limit the error 02h will be generated.

7.4.2 Motor Supply Voltage

The motor supply voltage can be monitored with different warn and error levels.

Parameter Name	UPID	Description
Motor Supply Voltage Low	1018h	If the motor supply voltage sinks below this limit the warn bit Motor Supply Voltage Low (bit 2) is set.
Motor Supply Voltage High	1019h	If the logic supply voltage rises above this limit the warn bit Motor Supply Voltage High (bit 3) is set.

Parameter Name	UPID	Description
Motor Supply Voltage Too Low	101Ah	If the logic supply voltage sinks below this limit the error 03h will be generated.
Motor Supply Voltage Too High	101Bh	If the logic supply voltage rises above this limit the error 04h will be generated.

7.4.2.1 Phase Switch On Test

The parameters in the Phase Switch On Test section are used in the HW Tests State (State 5) before enabling the power stage. If the motor power supply is on and there is no ground path in the motor (inclusive cabling) the phase voltage is approx. 6.5V when in power off state. When moving the motor the induced voltage may lead to HW test error.

Parameter Name	UPID	Description
Phase Voltage Low Level	102Ch	If one of the phase voltages is below this limit before powering up an error will be generated.
Phase Voltage High Level	102Dh	If one of the phase voltages is above this limit before powering up an error will be generated.

As a next motor cabling test step, one single end of a phase is set to half of the motor supply voltage. At this time, the current into the drive has to be below the Phase Test Max Incurrent value. An error will be generated otherwise.

Parameter Name	UPID	Description
Phase Test Max Incurrent	102Eh	If the current rises above this limit if one edge of a phase is set to a voltage an error will be generated.

7.4.3 Regeneration Resistor

The regeneration resistor terminals on X1 can be used for energy dissipation, when the motor is decelerating.

Parameter Name	UPID	Description
Enable	101Dh	The regeneration resistor output can be activated with this parameter: <ul style="list-style-type: none">• 0: Disable• 1: Enable

In the configuration section the switch on and off voltage levels for the regeneration resistor can be defined. The turn on voltage has to be at minimum 0.5V higher than the turn off voltage. Ensure that the idle motor supply voltage is lower than the turn off voltage!

Parameter Name	UPID	Description
Turn On Voltage	101Eh	If the Motor Supply Voltage rises above this limit the low side switch of the regeneration output is activated.
Turn Off Voltage	101Fh	If the Motor Supply Voltage sinks below this limit the low side switch of the regeneration output is turned off.

With the RR Temp Calculated section, the temperature model of the regeneration resistor is parameterized. This is used for avoiding damages to the regeneration resistor if the energy dissipation rises over the resistor's capabilities.

Parameter Name	UPID	Description
RR Resistance	1022h	Resistance value of the regeneration resistor. This value is used for calculating how much heat energy is generated in the resistor at the current DC link voltage.
Warning Temp	1024h	If Calc Temp RR Winding (UPID1C0Dh) of the calculated temperature model rises above this value, bit 10 of the Warn Word is set.
Error Temp	1025h	If Calc Temp RR Winding (UPID1C0Dh) of the calculated temperature model rises above this value, the drive goes to error state with the error 15h.

In the Temp Model Parameters section the regeneration resistor's temperature model is defined.

Parameter Name	UPID	Description
C Resistor	1026h	Heat capacity of the resistor winding itself.
R Winding Housing	1027h	Thermal resistance value between resistor winding and its housing.
C Housing	1028h	Heat capacity of the resistor housing.
R Housing Environment	1029h	Thermal resistance value between resistor housing and environment.
Environment Temperature	102Ah	Environmental temperature of the regeneration resistor.

The figure below shows the implemented temperature model for the regeneration resistor.

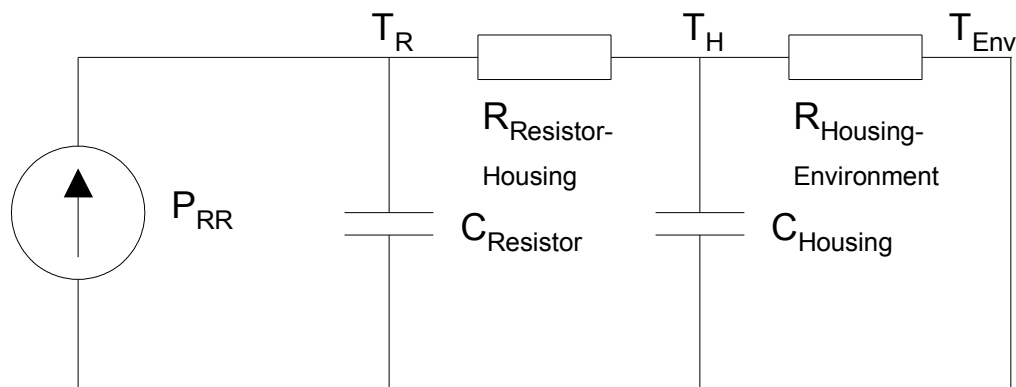

7.4.4 Temperature Monitoring

The E1100 drive hardware contains eight absolute temperature sensors for thermal protection. On the B1100 drive is one sensor placed.

Parameter Name	UPID	Description
Temp Sens Warn Level	1040h	If the maximal board temperature rises above this level, a warning is generated (bit 6 in Warn Word is set).
Temp Sens Error Level	1041h	If the maximal board temperature rises above this level, the error is generated (error codes 10h..17h).

The table below shows the mapped variables of the temperature monitoring.

Variable Name	UPID	Description
Power Bridge Temp Ph1+	1BC6h	Temperature of power driver Phase 1+ (E1100 only)
Power Bridge Temp Ph1-	1BC7h	Temperature of power driver Phase 1- (E1100 only)
Power Bridge Temp Ph2+	1BC8h	Temperature of power driver Phase 2+ (E1100 only)
Power Bridge Temp Ph2-	1BC9h	Temperature of power driver Phase 2- (E1100 only)
Power Bridge Temp Ph2+	1BC9h	Temperature of power driver Phase 2+ (E1100 only)

Power Bridge Temp DCLV+	1BCAh	Temperature of power drivers DC link voltage (E1100 only)
Temp RR Driver	1BCBh	Temperature of Regeneration Resistor low side driver (E1100 only)
Connector Temp X3	1BCCh	Temperature of motor connector X3 (E1100 only)
Temp Core	1BCDh	Temperature near microcontroller core (E1100 only)
Max Drive Temp	1BCEh	Maximal temperature of above variables

7.5 PosCtrlStructure

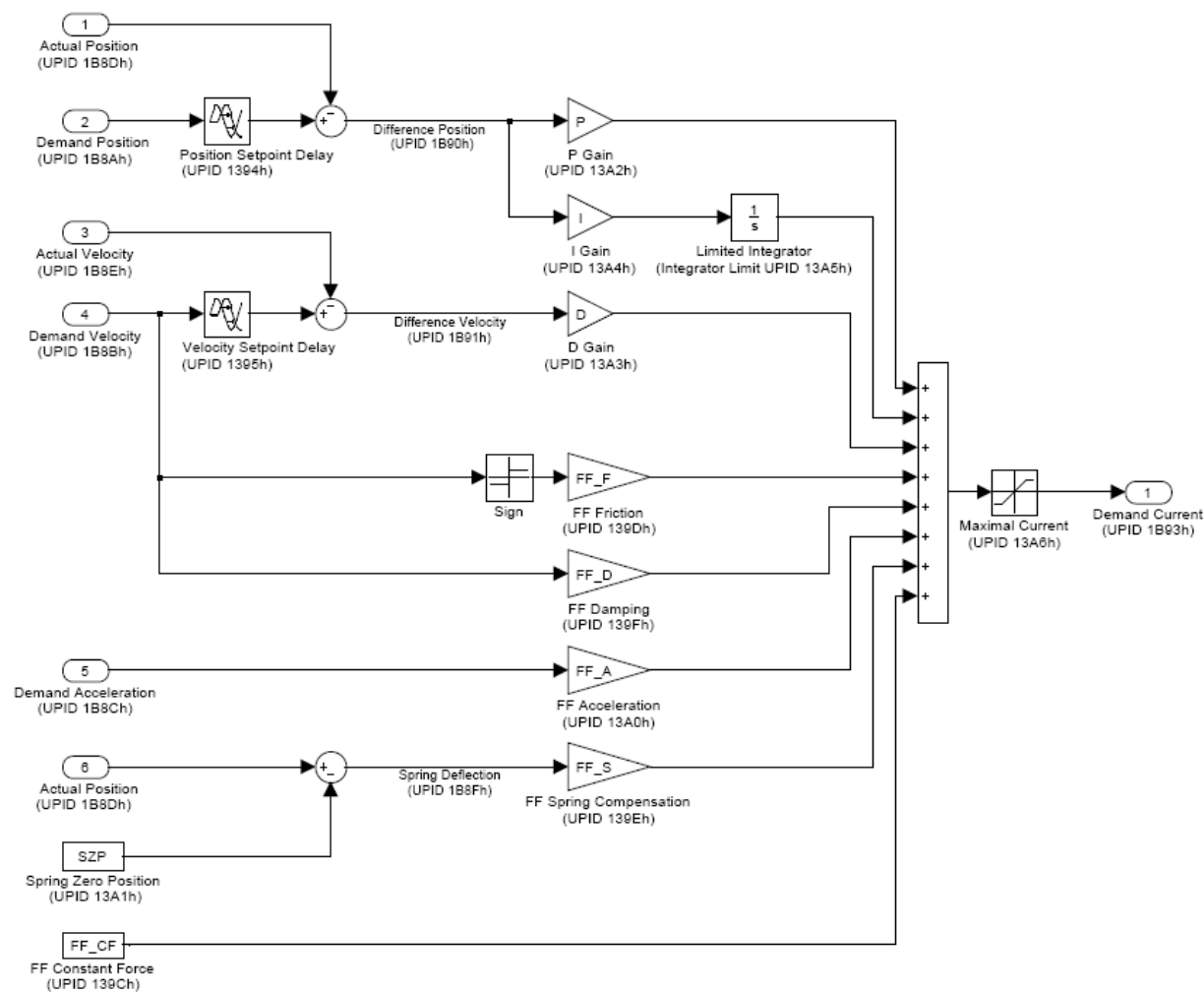

8 Motor Configuration

The motor usually is set up with the motor wizard, which sets all needed parameters. Therefore a detailed description of the parameters will follow in the future.

8.1 Generic Motor Temperature Calculated

For third parties motors a generic calculated motor temperature model is used to adapt the winding resistance and to detect excess temperature.

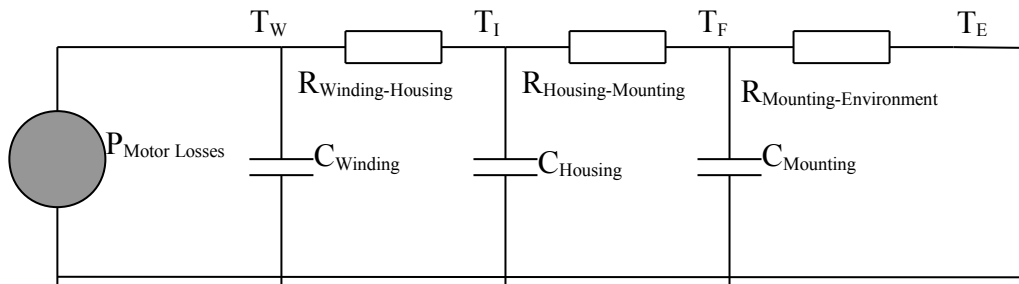

C Winding:	UPID 120Ch
R Winding-Housing:	UPID 1210h
C Housing:	UPID 1211h
R Housing-Mounting:	UPID 1212h
C Mounting:	UPID 1213h
R Mounting-Environment:	UPID 1214h

The sum of all R defines the static power losses (consider also T_W and T_E). With the capacitance the thermal time constant can be influenced. The bigger the thermal capacitance the slower the temperature will rise.

9 State Machine Setup

In the state machine setup sections the parameters to influence the behavior of the single states can be defined.

10 Error Code List

Code	Description	Actions to take
0000h	No Error	No error is pending.
0001h	Err: X4 Logic Supply Too Low	The logic supply voltage has been too low. The minimal logic supply voltage level is defined through parameter 100Eh. Recommended actions: check your 24V logic power supply.
0002h	Err: X4 Logic Supply Too High	The logic supply voltage has been too high. The maximal logic supply voltage level is defined through parameter 1010h. Recommended actions: check your 24V logic power supply.
0003h	Err: X1 Pwr Voltage Too Low	The motor power supply voltage has been too low. The minimal motor supply voltage level is defined through parameter 101Ah. Recommended actions: check your motor power supply, check the wiring, check the sizing of the power supply, add a capacitor too enforce your DC link.
0004h	Err: X1 Pwr Voltage Too High	The motor power supply voltage has been too high. The maximal motor supply voltage level is defined through parameter 101Bh. Back EMF effects may boost the DC link voltage. Recommended actions: check your motor power supply, check the wiring, check the sizing of the power supply, use a regeneration resistor for power dissipation, add a capacitor too enforce your DC link.
0005h	Err: X1 RR Not Connected	A regeneration resistor is configured (see parameter 101Dh) but not connected. Recommended actions: connect the regeneration resistor to X1.
0006h	Err: PTC 1 Sensor Too Hot	The PTC 1 sensor on X4.10 is hot or not connected. Recommended actions: check the temperature, check the wiring
0007h	Err: Min Pos Undershot	The motor position has been below the minimal position (see parameter 146Eh). Recommended actions: check the configuration, check the PLC program
0008h	Err: Max Pos Overshot	The motor position has been above the maximal position (see parameter 146Fh). Recommended actions: check the configuration, check the PLC program
0009h	Err: Ext-Int Sensor Diff Err	The position difference between sensor feedback on X3 and sensor feedback on X12 has been too big. Recommended actions: check sensor wiring, check sensor configuration (count direction, etc.), check parameter 1266h
000Ah	Fatal Err: X12 Signals Missing	The external sensor is not connected to X12 or the wiring is not ok. Recommended actions: check the wiring

000Bh	Err: Pos Lag Always Too Big	The motor was not able to follow the demand position. The maximal allowed position difference is defined through parameter 1473h. Recommended actions: check the motor load, check the motor stroke range for possible collisions, check the position controller setup, check the setpoint generation (unreachable speed/acceleration values?), check the motor sizing.
000Ch	Err: Pos Lag Standing Too Big (Not on B1100)	The motor was not able to reach the target position or was not able to stay at the target position. The maximal allowed position difference is defined through parameter 1475h. Recommended actions: check the motor load, check the motor stroke range for possible collisions, check the position controller setup, check the motor sizing
000Dh	Fatal Err: X1 Pwr Over Current	Over current on X1 detected. Recommended actions: check motor wiring, check motor configuration, for P01-48 type motors: set parameter 11F4h to value 0001h
000Eh	Err: Supply Dig Out Missing	The drive board is defective. Recommended actions: contact support for repair
000Fh	Err: PTC 2 Sensor Too Hot	The PTC 2 sensor on X4.11 is hot or not connected. Recommended actions: check the temperature, check the wiring
0010h	Err: Drive Ph1+ Too Hot	The drive power bridge phase 1+ is too hot. Recommended actions: check motor wiring
0011h	Err: Drive Ph1- Too Hot	The drive power bridge phase 1- is too hot. Recommended actions: check motor wiring
0012h	Err: Drive Ph2+ Too Hot	The drive power bridge phase 2+ is too hot. Recommended actions: check motor wiring
0013h	Err: Drive Ph2- Too Hot	The drive power bridge phase 2- is too hot. Recommended actions: check motor wiring
0014h	Err: Drive Pwr Too Hot	DC link temp sensor has detected over temperature. Recommended actions: check wiring
0015h	Err: Drive RR Hot Calc	Regeneration resistor switch hot: Recommended actions: check RR configuration (Turn On level, Resistance, etc.), check RR sizing
0016h	Err: Drive X3 Too Hot	Temp sensor on X3 has detected over temperature. Recommended actions: check motor wiring
0017h	Err: Drive Core Too Hot	Temp sensor on drive's PCB board reports core being hot.
0018h	Err: Power Bridge Ph1+ Defective	The drive power bridge phase 1+ may be defective. Recommended actions: contact support
0019h	Err: Power Bridge Ph1- Defective	The drive power bridge phase 1- may be defective. Recommended actions: contact support
001Ah	Err: Power Bridge Ph2+ Defective	The drive power bridge phase 2+ may be defective. Recommended actions: contact support

001Bh	Err: Power Bridge Ph2- Defective	The drive power bridge phase 2- may be defective. Recommended actions: contact support
001Ch	Err: Supply DigOut X6 Fuse Blown	Supply fuse for digital outputs on X6 blown. Recommended actions: check X6 wiring, contact support for repair
001Dh	Err: Supply X3.3 5V Fuse Blown	Supply X3.3 5V fuse blown. Motor or and/or wiring defective. Recommended actions: contact support for drive repair, check motor and wiring, replace motor and motor cables
001Eh	Err: Supply X3.8 AGND Fuse Blown	Supply X3.8 analog ground fuse blown. Recommended actions: contact support for drive repair, check motor and wiring, replace motor and motor cables
0020h	Err: Motor Hot Sensor	Temp sensor reports hot motor. Recommended actions: wait until motor has cooled down (until corresponding warning disappears, check load, check the motor configuration, check the setpoint generation (unreachable speed/acceleration values?), check the motor sizing
0021h	Fatal Err: X3 Hall Sig Missing	Motor hall signals not connected to X3 or motor defective: Recommended actions: Power down the drive and all power supplies, then reconnect motor, check motor and wiring, check parameter 1221h.
0022h	Fatal Err: Motor Slider Missing	Motor hall sensors cannot see magnetic field of the slider. The motor position was outside the allowed range defined through the motors ZP and Max Stroke data (see data sheet). Recommended actions: check stroke range, check slider orientation.
0023h	Err: Motor Short Time Overload	Short time motor overload detected. Recommended actions: check if motor is blocked, check motor sizing
0024h	Err: RR Hot Calculated	Regeneration resistor hot calculated. Recommended actions: check RR configuration (Turn On level, Resistance, etc.), check RR sizing
0025h	Err: Sensor Alarm	Sensor Alarm On X12 Occurred. Recommended actions: Check sensor mounting, band contamination or motion speed
0028h	Err: Ph1+ Short Circuit To GND	Short circuit between phase 1+ and ground detected. Recommended actions: check motor wiring, check motor
0029h	Err: Ph1- Short Circuit To GND	Short circuit between phase 1- and ground detected. Recommended actions: check motor wiring, check motor
002Ah	Err: Ph2+ Short Circuit To GND	Short circuit between phase 2+ and ground detected. Recommended actions: check motor wiring, check motor

002Bh	Err: Ph2- Short Circuit To GND	Short circuit between phase 2- and ground detected. Recommended actions: check motor wiring, check motor
002Ch	Err: Ph1 Short Circuit To Ph2	Short circuit between motor phase 1 and phase 2 detected. Recommended actions: check motor wiring, check motor
0030h	Err: Ph1+ Wired To Ph2+	Motor phase 1+ has contact to phase 2+. Recommended actions: check motor wiring, check motor
0031h	Err: Ph1+ Wired To Ph2-	Motor phase 1+ has contact to phase 2-. Recommended actions: check motor wiring, check motor
0032h	Err: Ph1+ Not Wired To Ph1-	Motor phase 1+ has no connection to phase 1-. Recommended actions: check motor wiring, check motor
0033h	Err: Ph2+ Wired To Ph1+	Motor phase 2+ has contact to phase 1+. Recommended actions: check motor wiring, check motor
0034h	Err: Ph2+ Wired To Ph1-	Motor phase 2+ has contact to phase 1-. Recommended actions: check motor wiring, check motor
0035h	Err: Ph2+ Not Wired To Ph2-	Motor phase 2+ has no connection to phase 2-. Recommended actions: check motor wiring, check motor
0036h	Err: Ph1 Short Circuit To Ph2+	Short circuit between motor phase 1 and phase 2+ detected. Recommended actions: check motor wiring, check motor
0037h	Err: Ph1 Short Circuit To Ph2-	Short circuit between motor phase 1 and phase 2- detected. Recommended actions: check motor wiring, check motor
0038h	Err: Ph2 Short Circuit To Ph1+	Short circuit between motor phase 2 and phase 1+ detected. Recommended actions: check motor wiring, check motor
0039h	Err: Ph2 Short Circuit To Ph1-	Short circuit between motor phase 2 and phase 1- detected. Recommended actions: check motor wiring, check motor
003Ah	Err: Phase U Broken	Motor phase U broken. Recommended actions: check motor wiring, check motor
003Bh	Err: Phase V Broken	Motor phase V broken. Recommended actions: check motor wiring, check motor
003Ch	Err: Phase W Broken	Motor phase W broken. Recommended actions: check motor wiring, check motor

0040h	Err: X4.3 Brake Driver Error	X4.3 brake driver reports error. Recommended actions: check for short circuit on X4.3
0041h	Err: Dig Out X4.4..X4.11 Status	X4.3..X4.11 output driver reports error. Recommended actions: check for short circuit on outputs X4.4..X4.11 or output configurations.
0042h	Err: Dig Out X6 Status	X6 output driver reports error. Recommended actions: check for short circuit on outputs X6.
0044h	Err: X4 Dig Out Defective	Digital outputs on X4 defective. Recommended actions: check X4 wiring, contact support for repair
0045h	Fatal Err: Motor Comm Lost	Motor communication lost. Recommended actions: Power down and check motor wiring and motor, replace cable and/or motor.
0046h	Err: PTC 1 Broken	PTC 1 on X4.10 broken or not connected. Recommended actions: Power down and check PTC 1 wiring and resistance.
0047h	Err: PTC 1 Short To 24V	PTC 1 on X4.10 short to 24V. Recommended actions: Power down and check PTC 1 wiring and resistance.
0050h	Setup Err: HW Not Supported	Setup error, hardware is not supported by the software. Recommended actions: download correct firmware, contact support
0051h	Setup Err: SW Key Missing	Software key and access code for special functionality is missing. Recommended actions: Order the SW key with your support together with the serial number of your HW.
0058h	Runtime Err: ROM write error	Runtime error, MC SW was not able to change parameter value in ROM. Recommended actions: verify PLC is not configuring during this action, contact support
0060h	Cfg Err: RR Voltage Set Too Low	Configuration error: regeneration resistor turn on/off voltage parameter value is too low. Recommended actions: check parameters 101Eh and 101Fh
0061h	Cfg Err: RR Hysteresis < 0.5V	Configuration error: regeneration resistor turn on/off voltage parameter values too close to each other. Recommended actions: check parameters 101Eh and 101Fh
0062h	Cfg Err: Curve Not Defined	Configuration error. Software tried to start a curve that is not defined yet. Action to take: define the curve using the curves service, check if curves were downloaded to drive, check the curve IDs, check the configuration, check the PLC program
0063h	Cfg Err: Pos Ctrl Max Curr High	Configuration error: Invalid max current setting in control parameters. Recommended actions: check parameters 13A6h and 13BAh, check PLC program
0064h	Cfg Err (Fatal): No Motor Defined	Configuration error: No motor has been configured yet. Recommended actions: use the motor wizard to configure the motor
0065h	Cfg Err (Fatal):	Configuration error: Digital input X4.6 is configured for

	No Trigger Mode Defined	trigger input function, but the trigger mode is not defined yet. Recommended actions: configure parameter 170Ch
0067h	Cfg Err (Fatal): Wrong Stator Type	Configuration error: The configured motor type does not match with the connected motor. Recommended actions: configure correct motor type by using the motor wizard, connect an appropriate motor
0068h	Cfg Err (Fatal): No Motor Communication	Configuration error: The drive was not able to establish the communication to the microcontroller on the motor. Older P01 motors don't support motor communication. Recommended actions: check motor wiring, check motor, check the motor configuration, disable communication by using parameter 11FBh if you have an old P01 motor.
0069h	Cfg Err: Wrong Slider	Configuration error: A wrong slider has been configured or slider home position has an invalid value. Recommended actions: reconfigure the motor by using the motor wizard
0080h	User Err: Lin: Not Homed	User error: The PLC program tried to start an action that requires the motor to be already homed, but the motor was not homed. Recommended actions: check the PLC program, do a homing of the motor first
0081h	User Err: Unknown Motion Cmd	User error: The PLC program sent an unknown motion command ID. Recommended actions: check PLC program, check firmware version
0082h	User Err: PVT Buffer Overflow	User error: The PLC program has sent the stream position commands too fast, the buffer had an overflow. Streaming has to be strictly cyclic! Recommended actions: check PLC program, check the fieldbus by using bus monitor tools
0083h	User Err: PVT Buffer Underflow	User error: The PLC program has sent the stream position commands too slowly, the buffer had an underflow. Streaming has to be strictly cyclic! Recommended actions: check PLC program, check the fieldbus by using bus monitor tools
0084h	User Err: PVT Master Too Fast	User error: The PLC program has begun to send PVT streaming command. The commands were too close to each other. The drive expects new streaming commands every 2ms to 5ms. Recommended actions: check PLC program, check the fieldbus by using bus monitor tools
0085h	User Err: PVT Master Too Slow	User error: The PLC program has begun to send PVT streaming command. The cycle time between the streaming commands has been too long. The drive expects new streaming commands every 2ms to 5ms. Recommended actions: check PLC program, check the fieldbus by using bus monitor tools

0086h	User Err: Motion Cmd In Wrong St	User error: The PLC program has sent a motion command while the drive was not in an appropriate operational state. Most of the motion commands are accepted only in operational state 8 (Operation Enabled). Recommended actions: check the PLC program
0087h	User Err: Limit Switch In High	User error: The motor moved into the Limit Switch In while it was still in the stroke range. Recommended actions: check the PLC program or check homing
0088h	User Err: Limit Switch Out High	User error: The motor moved into the Limit Switch Out while it was still in the stroke range. Recommended actions: check the PLC program or check homing
0089h	User Err: Curve Amp Scale Error	User error: The automatic calculated amplitude scale is out of range -2000percent to 2000percent. Recommended actions: check the PLC program or use other curve
008Ah	User Err: Cmd Tab Entry Not Def	Called command Table entry is not defined. Recommended actions: check the PLC program or define Command Table Entry.

11 Contact Addresses

SWITZERLAND

NTI AG
Haerdlistr. 15
CH-8957 Spreitenbach

Sales and Administration: +41-(0)56-419 91 91
office@linmot.com

Tech. Support: +41-(0)56-544 71 00
support@linmot.com

Tech. Support (Skype) : <skype:support.linmot>

Fax: +41-(0)56-419 91 92
Web: <http://www.linmot.com/>

USA

LinMot, Inc.
204 E Morrissey Dr.
Elkhorn, WI 53121

Sales and Administration: 877-546-3270
262-743-2555

Tech. Support: 877-804-0718
262-743-1284

Fax: 800-463-8708
262-723-6688

E-Mail: us-sales@linmot.com
Web: <http://www.linmot-usa.com/>

Please visit <http://www.linmot.com/> to find the distribution near you.

Smart solutions are...

