

CDE/CDB/ CDF3000

Application Manual

Positioning drive systems
2 A to 170 A (CDE)
375 W to 90 kW (CDB)
470 W (CDF)

Adapting the drive system to
the application



*With the delivery
(depending on scope of
delivery)*

Overview of documentation

Operation manual



Quick and easy initial
commissioning

Application Manual



Adapting the drive system to
the application



Application Manual CDE/CDB/CDF3000

ID no.: 1001.22 B.1-00

Status: 06/2005

Valid from software version V0.55 CDE3000

Valid from Software version V1.30 CDB3000

Valid from software version V1.00 CDF3000

Subject to technical changes without notice.

Guide through this manual

Dear user

this manual mainly addresses you as a **programmer** for drive and automation solutions. It describes how you can match your new drive system optimally to the corresponding application. At this point we assume that your drive is already running – otherwise you should first read the operating instructions.

Don't let the sheer volume of this manual put you off: Only the chapters 1 to 3 contain basic information you should become familiar with. All other chapters and the appendix are intended for **looking up information**. (They show the full scope of functions and the flexibility of the software for the positioning controllers to solve the most diverse drive tasks.)

1	Safety	1
2	Device hardware	2
3	Operation structure	3
4	Encoder	4
5	Positioning controller	5
6	General software functions	6
7	User programming	7
8	Speed control "OpenLoop"	8
	Appendix: Error messages and index	A

Pictograms





➤ **Note:** Useful information



➤ **Cross-reference:** Further information in other chapters of the user manual or additional documentations



➤ **Step 1:** Step-by-step instructions

Warning symbol	General explanation	Danger class acc. to ANSI Z 535
	Attention! Operating errors may cause damage to or malfunction of the drive.	This may result in physical injury or damage to material.
	Danger, high voltage! Improper behaviour may cause fatal accident.	Danger to life or severe physical injury.
	Danger from rotating parts! The drive may automatically start.	Danger to life or severe physical injury.

Contents

1	Safety	
1.1	Measures for your safety	1-1
1.2	Intended use	1-3
1.3	Responsibility	1-4
2	Equipment hardware	
2.1	Terminal positions CDE3000	2-2
2.2	Terminal positions CDB3000	2-7
2.3	Terminal positions CDF3000	2-11
2.4	Light emitting diodes	2-15
2.5	Resetting parameter settings	2-16
2.6	Loading device software	2-17
2.7	Device protection	2-18
3	Operation structure	
3.1	Operation levels in the parameter structure	3-2
3.2	Operation with DRIVEMANAGER	3-4
3.2.1	Operation masks	3-5
3.3	Operation with KP200-XL operation panel	3-9
3.4	Commissioning	3-14
4	CDE/CDB/CDF3000 in rotary speed operation	
4.1	Preset solutions	4-2
4.2	General functions	4-3
4.2.1	Torque / rotary speed profile generator	4-3
4.2.2	Limitations/Stop ramps	4-5

4.3	Torque control with reference value via analog input	4-6
4.4	Speed control with reference value via analog input	4-6
4.5	Speed control with reference value from fixed speed table	4-7
4.6	Speed control with reference value and control via field bus	4-9
4.6.1	CANopen	4-9
4.6.2	PROFIBUS	4-10
4.7	Speed control with reference value via PLC	4-10
4.8	Assignment of control terminal	4-10
4.8.1	Terminal assignment CDE3000	4-11
4.8.2	Terminal assignment CDB3000	4-12
4.8.3	Terminal assignment CDF3000	4-13
5	CDE/CDB/CDF3000 in positioning operation	
5.1	Pre-set solutions	5-2
5.2	General functions	5-4
5.2.1	Positioning modes	5-5
5.2.2	Units and standardization	5-6
5.2.3	Travel profile	5-9
5.2.4	Referencing	5-13
5.2.5	Limit switch	5-25
5.2.6	Manual operation / Jog mode	5-26
5.3	Positioning with table travel sets	5-28
5.3.1	Travel set selection	5-28
5.3.2	Sequence of travel set selection with follow-up order logic	5-30
5.3.3	Parameterization of the travel set table	5-32
5.3.4	Switching points	5-37
5.3.5	Teach in	5-39

5.4	Positioning and control via field bus	5-40
5.4.1	CANopen	5-40
5.4.2	PROFIBUS	5-40
5.5	Positioning with PLC	5-41
5.6	Assignment of control terminal	5-41
5.6.1	Terminal assignment CDE3000	5-42
5.6.2	Terminal assignment CDB3000	5-43
5.6.3	Terminal assignment CDF3000	5-44
6	General software functions	
6.1	Inputs and outputs	6-3
6.1.1	Digital inputs	6-4
6.1.2	Digital outputs	6-13
6.1.3	Analog inputs	6-24
6.1.4	Analog output for CDB3000	6-30
6.2	Setpoint generation	6-33
6.2.1	Rotary speed profile	6-34
6.2.2	Limitations	6-35
6.2.3	Stop ramps	6-37
6.2.4	Reference encoder/Master-Slave operation	6-40
6.2.5	Setpoint structure - further settings/control location	6-47
6.2.6	Control location	6-55
6.2.7	Motor potentiometer function	6-58
6.3	Motor control	6-62
6.4	Motor and transducer	6-67
6.4.1	Motor data	6-67
6.4.2	Encoder	6-74
6.4.3	Motor protection	6-83
6.4.4	Motor holding brake	6-90
6.5	Bus systems	6-100
6.5.1	CANopen	6-100
6.5.2	PROFIBUS	6-104
6.6	Cam controller	6-106

6.7	Setting KP200-XL	6-112
6.8	Actual values	6-117
6.8.1	Temperature monitoring	6-117
6.8.2	Device data	6-118
6.8.3	Options	6-119
6.8.4	CANopen Field bus	6-122
6.9	Warnings/errors	6-124
6.9.1	Error messages	6-124
6.9.2	Warning messages	6-131
7	User programming	
7.1	PLC functionality	7-3
7.2	PLC program	7-4
7.2.1	PLC editor	7-4
7.2.2	New generation of program	7-5
7.2.3	PLC program structure	7-5
7.2.4	Program testing and editing	7-7
7.2.5	PLC program files	7-7
7.2.6	Program handling	7-8
7.3	PLC command syntax	7-10
7.3.1	Overview	7-11
7.3.2	Detailed explanations	7-17
7.4	PLC control and parameters	7-41
7.4.1	PLC variables	7-42
7.4.2	PLC control parameters	7-43
7.5	PLC program examples	7-45
7.5.1	Conveyor belt	7-46
7.5.2	Absolute positioning	7-47
7.5.3	Relative positioning	7-49
7.5.4	Sequential program	7-50

8	Speed Control "OpenLoop" for CDE/ CDB3000	
8.1	Preset solutions	8-2
8.2	General functions	8-3
8.2.1	Data set changeover	8-3
8.2.2	Speed profile generator "OpenLoop"	8-5
8.2.3	Limitations/Stop ramps	8-8
8.3	"OpenLoop" motor control method	8-10
8.3.1	Start current controller	8-11
8.3.2	Vibration damping controller	8-13
8.3.3	Current limit controller	8-14
8.3.4	DC-holding current controller	8-16
8.3.5	v/f-characteristics curve	8-17
8.4	Speed control "OpenLoop" with 0-10 V or fixed speeds	8-19
8.5	Speed control "OpenLoop" with setpoint and control via field bus	8-22
A	Appendix	
A.1	Overview of all error messages	A-2
B	Index	

1.1 Measures for your safety

1 Safety

In order to avoid physical injury and/or material damage the following information must be read before initial start-up.

The safety regulations must be strictly observed at any time.



Read the Operation Manual first!

- Follow the safety instructions!
- Please observe the user information



Electric drives are generally potential danger sources:

- Electrical voltage <math><230\text{ V}/460\text{ V}</math>: Dangerously high voltage may still be present 10 minutes after the power is cut. You should therefore always check that the system has been deenergized. (applies only for CDE/CDB3000)
- Rotating parts
- Hot surfaces



Protection against magnetic and/or electromagnetic fields during installation and operation.

- For persons with pacemakers, metal containing implants and hearing aids etc. access to the following areas is prohibited:
 - Areas in which drive systems are installed, repaired and operated.
 - Areas in which motors are assembled, repaired and operated. Motors with permanent magnets are sources of special dangers.



Danger: If there is a necessity to access such areas a decision from a physician is required.

**Your qualification:**

- In order to prevent personal injury or damage to property, only personnel with electrical engineering qualifications may work on the device.
- The qualified personnel must familiarise themselves with the Operation Manual (refer to IEC364, DIN VDE0100).
- Knowledge of the national accident prevention regulations (e. g. VBG 4 in Germany)

**During installation follow these instructions:**

- Always comply with the connection conditions and technical specifications.
- Comply with the standards for electrical installations, such as wire cross-section, earthing lead and ground connections.
- Do not touch electronic components and contacts (electrostatic discharge may destroy components).

1.2 Intended use

Drive controllers are components for installation into stationary electric systems or machines.

When installed in machines the commissioning of the drive controller (i. e. start-up of intended operation) is prohibited, unless it has been ascertained that the machine fully complies with the regulations of the EC-directive 98/37/EC (Machine Directive); compliance with EN 60204 is mandatory.

Commissioning (i. e. starting intended operation) is only permitted when strictly complying with EMC-directive (89/336/EEC).



The series CDE/CDB3000 complies with the low voltage directive 73/23/EEC

For the drive controller the harmonized standards of series EN 50178/ DIN VDE 0160 in connection with EN 60439-1/ VDE 0660 part 500 and EN 60146/ VDE 0558 are applied.



The series CDF3000 complies with the EMC directive 89/336/EEC

The harmonized standards EN 50178/DIN VDE 0160 and EN 61800-3 are applied for the drive controllers.

If the drive controller is used in special applications, e. g. in areas subject to explosion hazards, the applicable regulations and standards (e. g. in Ex-environments EN 50014 "General provisions" and EN 50018 "Flameproof housing") must be strictly observed.

Repairs must only be carried out by authorized repair workshops. Unauthorised opening and incorrect intervention could lead to physical injury or material damage. The warranty granted by LUST will become void.



Note: The use of drive controllers in mobile equipment is assumed an exceptional environmental condition and is only permitted after a special agreement.

1.3 Responsibility

Electronic devices are never fail-safe. The company setting up and/or operating the machine or plant is itself responsible for ensuring that the drive is rendered safe if the device fails.

EN 60204-1/DIN VDE 0113 "Safety of machines", in the section on "Electrical equipment of machines", stipulates safety requirements for electrical controls. They are intended to protect personnel and machinery, and to maintain the function capability of the machine or plant concerned, and must be observed.

An emergency stop system does not necessarily have to cut the power supply to the drive. To protect against danger, it may be more beneficial to keep individual drives running or to initiate specific safety sequences. Execution of the emergency stop measure is assessed by means of a risk analysis of the machine or plant, including the electrical equipment in accordance with DIN EN 1050, and is determined by selecting the circuit category in accordance with DIN EN 954-1 "Safety of machines - Safety-related parts of controls".

2 Equipment hardware

2.1	Terminal positions CDE3000	2-2
2.2	Terminal positions CDB3000	2-7
2.3	Terminal positions CDF3000	2-11
2.4	Light emitting diodes	2-15
2.5	Resetting parameter settings	2-16
2.6	Loading device software	2-17
2.7	Device protection	2-18



Info: This chapter shows general items concerning the equipment hardware, which are required to understand and work with the application manual. Further information on equipment hardware can be found in the corresponding operating instructions for the positioning controllers.

2.1 Terminal positions CDE3000

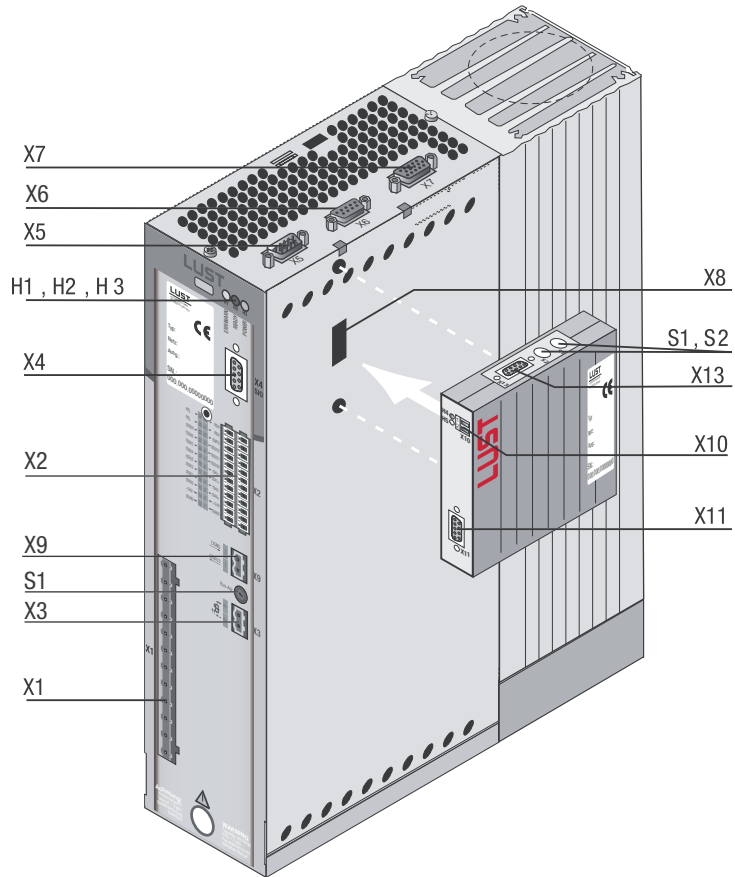

Fig. 2.1 View of device CDE3000

No.	Designation	Function
H1, H2, H3	Light emitting diodes	Equipment status display
S1	Encoder switch	Setting the CAN-address = hardware address + parameter value COADR
X1	Power terminal	Mains, motor, DC supply (L+/L-) up to < 22 kW: Braking resistor L+/RB, from > 22 kW: Braking resistor L-/RB

Table 2.1 Legend to "View of device CDE3000"

No.	Designation	Function
X2	Control terminal	8 digital inputs, 2 analog inputs, (10 bit) 3 digital outputs, 1 relay Safe stop with relay output
X3	Motor temperature monitoring	PTC, following DIN 44082 or KTY 84-130 (linear temperature sensor) or Klixon (thermal circuit breaker)
X4	RS232 port	for PC with DRIVEMANAGER or control unit KP200-XL
X5	CAN-interface	CAN _{open} - interface DSP402
X6	Resolver connection	Resolver
X7	TTL-/SSI encoder interface	TTL encoder SSI absolute value transducer, optionally: Sin-Cos transducer
X8	Optional board slot	Expansion board slot for e.g. optional module CM_DPV1 (PROFIBUS-DP)
X9	Brake driver	2A max.
X10	Voltage supply for optional module	+ 24 V, ground
X11	Interface PROFIBUS-DP	Input bus connection
X13	Address coding plug	Only with optional module DPV1
S1, S2	Address encoder switch	Only with optional module DPV1

Table 2.1 Legend to "View of device CDE3000"

Power terminal

























X1	Designation	X1	Designation
 U	Motor cable U	 U	Motor cable U
 V	Motor cable V	 V	Motor cable V
 W	Motor cable W	 W	Motor cable W
 ⚡	PE-conductor	 ⚡	PE-conductor
 ⚡	PE-conductor	 ⚡	PE-conductor
 L+	D.C. ling voltage +	 L+	D.C. ling voltage +
 RB	Braking resistor	 RB	Braking resistor
 L-	D.C. ling voltage -	 L-	D.C. ling voltage -
 ⚡	PE-conductor	 ⚡	PE-conductor
 NC	NC	 L3	Mains phase L3
 N	Neutral conductor	 L2	Mains phase L2
 L1	Mains phase	 L1	Mains phase L1

Table 2.2 Power terminal designation CDE32.xxx and CDE34.xxx

Control terminal

X2	Designation	Function
1	DGND	digital ground
2	+24V	Auxiliary voltage $U_V = 24$ V DC
3	ISAO+	Analog input 10 bit ± 10 V
4	ISAO-	Analog input
5	ISA1+	Analog input 10 bit ± 10 V
6	ISA1-	Analog input
7	OSD00	Digital output
8	OSD01	Digital output
9	OSD02	Digital output
10	ENPO	Power stage hardware enable
11	RSH	Relay output safe stop
12	RSH	Relay output safe stop
13	DGND	digital ground
14	+24V	Auxiliary voltage $U_V = 24$ V DC
15	ISD00	Digital input 0
16	ISD01	Digital input 1
17	ISD02	Digital input 2
18	ISD03	Digital input 3
19	ISD04	Digital input 4
20	ISD05	Digital input 5
21	ISD06	Digital input 6
22	ISDSH	Digital input safe stop
23	REL	Relay output
24	REL	Relay output

Table 2.3 Signal assignment for control terminal X2, CDE3000

RS232

Pin-No.	Function
1	+15 V DC for control unit KP200-XL
2	TxD, data transmission
3	RxD, data reception
4	not used
5	GND for +15 V DC of the control unit KP200-XL
6	+24 V DC, voltage supply control print
7	not used
8	not used
9	GND for +24 V DC, voltage supply control print

Table 2.4 Pin assignment of the serial interface X4, 9-pin D-Sub socket

CAN

Pin-No.	Function
1	Wave terminating resistor 120 Ω internal for CAN by means of jumper between Pin 1 and Pin 2
2	CAN_LOW, CAN signal
3	CAN_GND, reference ground of CAN 24 V (Pin 9)
4	CAN-SYNC_LOW.
5	Wave terminating resistor 120 Ω internal for CAN-SYNC by means of jumper between Pin 5 and Pin 4
6	CAN_GND, bridged with Pin 3
7	CAN_HIGH, CAN signal
8	CAN-SYNC_HIGH.
9	CAN_+24 V (24 V ± 10%, 50 mA). This supply voltage is required for CAN operation.

Table 2.5 Pin assignment of CAN-interface X5, 9-pin D-Sub pin

Resolver

Pin-No.	Function
1	Sine+, S2
2	Sine-, S4
3	Cosine+, S1
4	+5V
5	PTC+, motor temperature monitoring
6	REF+, resolver excitation R2
7	REF-, excitation-, R1
8	Cosine-, S3
9	PTC-

Table 2.6 Pin assignment of resolver interface X6, 9-pin D-Sub, socket

Encoder

Pin-No.	Function		
	Sine/Cosine (optional)	SSI	Hiperface
1	A-	A-	REFCOS
2	A+	A+	+COS
3	+5V ± 5% at 150mA		
4	DATA+	DATA+	Data +, RS485

Table 2.7 Pin assignment for encoder interface X7, 15-pin D-Sub High Density, socket

Pin-No.	Function		
	Sine/Cosine (optional)	SSI	Hiperface
5	DATA-	DATA-	Data -, RS485
6	B-	B-	REFSIN
7			
8	GND	GND	GND
9	R-		
10	R+		
11	B+	B+	+SIN
12	Sense +		
13	Sense +		
14	CLK+	CLK+	
15	CLK-	CLK-	

Table 2.7 Pin assignment for encoder interface X7, 15-pin D-Sub High Density, socket

2.2 Terminal positions CDB3000

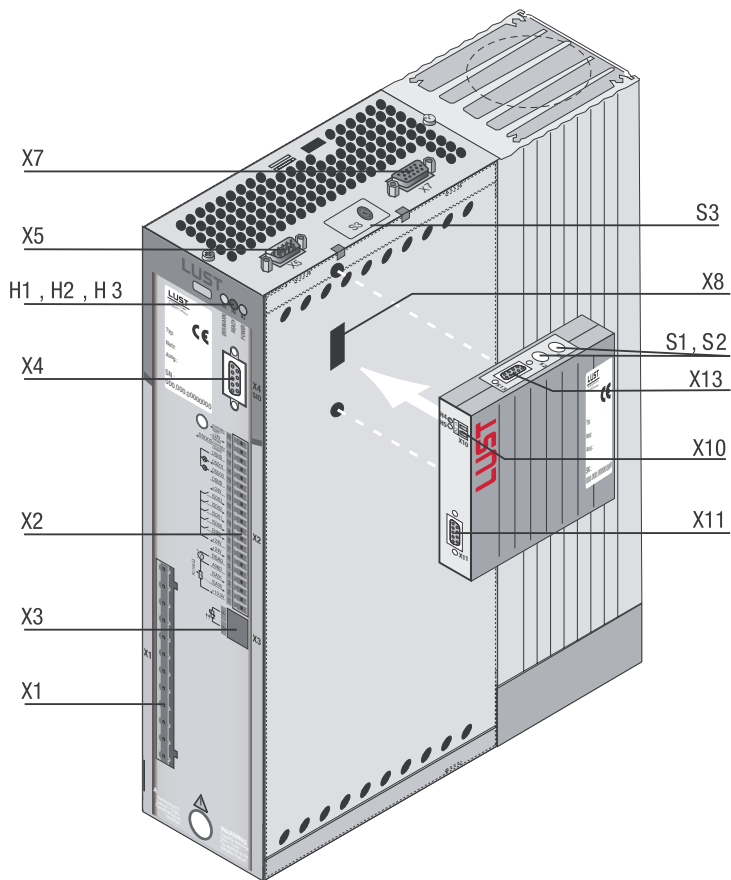

Fig. 2.2 Position plan CDB3000

No.	Designation	Function
H1, H2, H3	Light emitting diodes	Equipment status display
X1	Power terminal	Mains, motor, DC supply (L+/L-) up to < 22 kW: Braking resistor L+/RB, from > 22 kW: Braking resistor L+/RB
X2	Control terminal	4 digital inputs, 2 analog inputs 3 digital outputs, (of these 1 relay) 1 analog output
X3	PTC-terminal	PTC, thermal circuit breaker or linear temperature sensor KTY 84-130

Table 2.8 Legend to "Position plan CDB3000"

No.	Designation	Function
X4	RS232 port	for PC with DRIVEMANAGER or control unit KP200-XL
X5	CAN-interface	Access to integrated CAN-interface
X7	TTL-/SSI encoder interface	for connection of suitable encoders
S3	Address encoder switch CANopen	Setting the CAN-address = hardware address + parameter value COADR
X8	Optional board slot	e.g. optional module DPV1
X10	Voltage supply for optional module	+ 24 V, ground
X11	PROFIBUS-DP interface	Input bus connection
X13	Address encoder plug	Only with optional module DPV1
S1, S2	Address encoder switch	Only with optional module DPV1

Table 2.8 Legend to "Position plan CDB3000"

Power terminal

























X1	Designation	X1	Designation
 U	Motor cable U	 U	Motor cable U
 V	Motor cable V	 V	Motor cable V
 W	Motor cable W	 W	Motor cable W
 PE	PE-conductor	 PE	PE-conductor
 PE	PE-conductor	 PE	PE-conductor
 L+	D.C. ling voltage +	 L+	D.C. ling voltage +
 RB	Braking resistor	 RB	Braking resistor
 L-	D.C. ling voltage -	 L-	D.C. ling voltage -
 PE	PE-conductor	 PE	PE-conductor
 NC	NC	 L3	Mains phase L3
 N	Neutral conductor	 L2	Mains phase L2
 L1	Mains phase	 L1	Mains phase L1

Table 2.9 Power terminal designation CDB32.xxx und CDB34.xxx

Control terminal

X2	Designation	Function
20	OSD02/20	
19	OSD02/19	
18	OSD02/18	
17	DGND	digital ground
16	OSD01	digital output
15	OSD00	digital output
14	DGND	digital ground
13	U_V	Auxiliary voltage 24 V
12	ISD03	digital input
11	ISD02	digital input
10	ISD01	digital input
9	ISD00	digital input
8	ENPO	Power stage hardware enable
7	U_V	Auxiliary voltage 24 V DC
6	U_V	Auxiliary voltage 24 V DC
5	OSA00	analog output
4	AGND	analog ground
3	ISA01	analog input
2	ISA00	analog input
1	U_R	Reference voltage +10,5 V

Table 2.10 Control terminal designation CDB3000

RS232

Pin-No.	Function
1	+15 V DC for control unit KP200-XL
2	TxD, data transmission
3	RxD, data reception
4	not used
5	GND for +15 V DC of the control unit KP200-XL
6	+24 V DC, voltage supply control print
7	not used
8	not used
9	GND for +24V DC, voltage supply control print

Table 2.11 Pin assignment of the serial interface X4, 9-pin D-Sub socket

CAN

Pin-No.	Function
1	Wave terminating resistor 120 Ω internal for CAN by means of jumper between Pin 1 and Pin 2
2	CAN_LOW, CAN signal
3	CAN_GND, reference ground of CAN 24 V (Pin 9)
4	not used, please do not connect
5	not used, please do not connect
6	CAN_GND, bridged with Pin 3
7	CAN_HIGH, CAN signal
8	not used, please do not connect
9	CAN_+24 V (24 V ± 25%, 50 mA). This supply voltage is required for CAN operation.

Table 2.12 Pin assignment of CAN-interface X5, 9-pin D-Sub pin

Encoder

Pin-No.	Function TTL	Function SSI
1	A-	DATA-
2	A+	DATA+
3	+5 V / 150 mA	+5 V / 150 mA
4	not used, please do not connect	
5	not used, please do not connect	
6	B-	CLK-
7	not used, please do not connect	
8	GND	GND
9	R-	
10	R+	
11	B+	CLK+
12	+5 V (sensor)	+5 V (sensor)
13	GND (Sensor)	GND (Sensor)
14/15	Wave terminating resistor 120 Ω internal for track B by means of jumper between Pin 14 and Pin 15	

Table 2.13 Pin assignment for encoder terminal X7, 15-pin D-Sub High Density, socket

2.3 Terminal positions CDF3000

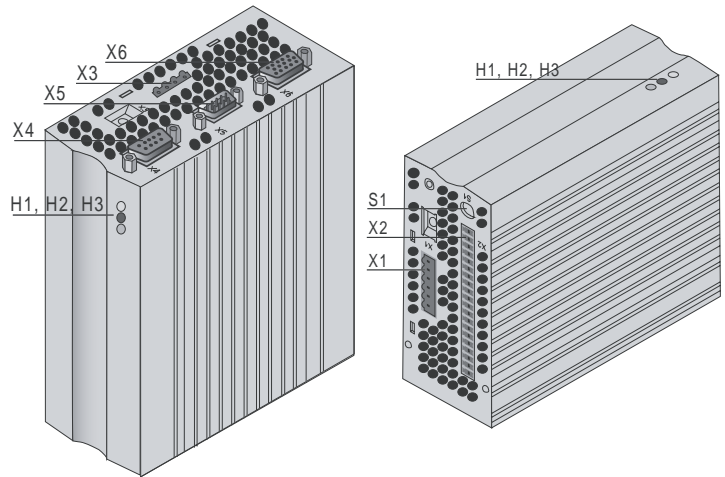

Fig. 2.3 View of device CDF3000

No.	Designation	Function
H1, H2, H3	Light emitting diodes	Equipment status display
S1	Encoder switch	Setting the CAN-address
X1	Power terminal	6-pin
X2	Control terminal	20-pin
X3	Motor power connection	4-pin
X4	RS232 port	for PC with DRIVEMANAGER or control unit KP200-XL
X5	CAN-interface	DSP402
X6	Resolver / SSI-transducer connection	15-pin HD-Sub-D (socket)

Table 2.14 Legend to "View of device CDF3000"

Power terminal

X1	Designation
	Supply 24V - 55V
	Ground connection
	PE-conductor
	PE-conductor
	Connection of external braking resistor
	Connection of external braking resistor

Table 2.15 Power terminal designation X1, CDF3000

Control terminal

X2	Designation	Function
20	-	Not assigned
19	-	Not assigned
18	RSH	Relay contact safe stop (make contact)
17	RSH	Relay contact safe stop (make contact)
16	ISDSH	Digital input safe stop
15	ISD02	Digital input
14	ISD01	Digital input
13	ISD00	Digital input
12	ENPO	Release of closed loop control
11	+24 V	+24 V supply
10	OSD00	Digital output
9	ISA1+	Analog input, differential +
8	ISA1-	Analog input, differential -
7	ISA0+	Analog input, differential +
6	ISA0-	Analog input, differential -
5	+24 V	+24 V supply for control element
4	GND	Ground connection
3	GND	Ground connection
2	OSD03	Digital output, motor brake driver 1 (0.5 A eff, 2A max)
1	OSD04	Digital output, motor brake driver 2 (0.5 A eff, 2A max)

Table 2.16 Signal assignment for control terminal X2

Motor connection

Terminal X3/ Pin	Designation
W	Motor phase connection (max. 1.5 mm ²)
V	
U	
PE	Earthing lead connection

Table 2.17 Motor terminal designation X3 CDF3000

RS232

Terminal X4/ Pin-No.	Function
1	+15 V DC for control unit KP200-XL
2	TxD, data transmission
3	RxD, data reception
4	not used
5	GND for +15 V DC of the control unit KP200-XL
6	+24 V DC, voltage supply control print
7	not used
8	not used
9	GND for +24V DC, voltage supply control print

Table 2.18 Pin assignment of the serial interface X4, CDF

CAN

Terminal X5 Pin-No.	Function
1	Wave terminating resistor 120 Ω internal for CAN by means of jumper between Pin 1 and Pin 2
2	CAN_LOW
3	CAN_GND
4	CAN_SYNC_LOW.
5	Wave terminating resistor 120 Ω internal for CAN-SYNC by means of jumper between Pin 4 and Pin 5
6	CAN_GND

Table 2.19 Pin assignment of CAN-interface X5, 9-pin D-Sub pin

Terminal X5 Pin-No.	Function
7	CAN_HIGH
8	CAN_SYNC_HIGH.
9	CAN_+24 V (24 V ± 25%, 50 mA) This supply voltage is required for CAN operation.

Table 2.19 Pin assignment of CAN-interface X5, 9-pin D-Sub pin

Resolver

Terminal X6/ Pin-No.	Function
1	Sine-, resolver (S4)
2	Sine+, resolver (S2)
3	+5V / 150 mA, SSI
4	DATA+, SSI
5	DATA-, SSI
6	Cosine-, resolver (S3)
7	REF-, resolver, (R2)
8	GND, SSI
9	PTC- (KTY / Klixon), resolver / SSI
10	PTC+ (KTY / Klixon), resolver / SSI
11	Cosine+, resolver (S1)
12	REF+, resolver, (R1)
13	do not use
14	CLK+, SSI
15	CLK-, SSI

Table 2.20 Pin assignment for resolver interface X6, 15-pin High Density D-Sub pin, socket

Brake driver

Terminal X2/ Pin- No.	Designation	Function	Electrical isolation
1	OSD04	short-circuit proof	yes
4	DGND	Cable breakage monitoring; suitable for controlling a motor holding brake.	

2.4 Light emitting diodes

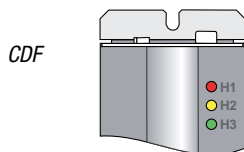
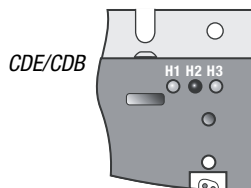

The positioning controller is fitted with three status LED's in red (H1), yellow (H2) and green (H3) at the top right.

Device status	red LED (H1)	yellow LED (H2)	green LED (H3)
Supply voltage 24 V DC (internal or external) for control element applied or closed loop control in "Parameterization" status	○	○	●
Ready (ENPO set)	○	●	●
In service/auto-tuning active	○	*	●
Warning (at Standby)	○	●	●
Warning (active with operation/self-adjustment)	○	*	●
Error	* (flash code)	○	●

○ LED off, ● LED on, * LED flashing

Table 2.21 Meaning of the light emitting diodes



Note: The parameterization mode by control unit is not separately indicated.

Flash code of red LED	Display control unit	Cause of fault
1x	E-CPU	Collective error message
2x	E-OFF	Undervoltage cut-off
3x	E-OC	Overcurrent cut-off
4x	E-OV	Overvoltage cut-off
5x	E-OLM	Motor overloaded
6x	E-OLI	Device overloaded
7x	E-OTM	Motor temperature too high
8x	E-OTI	Cooling temperature too high

Table 2.22 Error messages

Error messages can be displayed more accurately with the KP200-XL control unit or the DRIVEMANAGER.

2.5 Resetting parameter settings

Parameter reset

The resetting of parameter settings is divided into two areas with differing effects. The parameter reset returns an individual parameter to the last saved value. Device reset restores the entire dataset to factory setting (delivery defaults).

In the KEYPAD PARA menu:

If you are in the setup mode of a parameter and press the two arrow keys simultaneously, the parameter you are currently editing will be reset to the setting saved last.

In DRIVEMANAGER:

In the focussed settings window by actuating the F1-key. The factory setting of the parameter is to be taken and entered in the tab "Value Range".

Factory setting

KEYPAD:

Press both arrow keys of the KEYPAD simultaneously during servo controller power-up to reset all parameters to their factory defaults and reinitialise the system

DRIVEMANAGER:

Select function "Reset to factory default" in the menu "Active device".



Fig. 2.4 Reset in DRIVEMANAGER



Note: This factory setting also resets the selected default solution. Check the terminal assignment and the functionality of the positioning controller in these operating modes or load your user dataset.

2.6 Loading device software

With the DRIVEMANAGER you can load a new device software (Firmware) into the Flash-EEPROM of the devices. This enables updating of the software without having to open the positioning controllers.

1. For this purpose set up a connection between DRIVEMANAGER and positioning controllers.
2. From the menu "Options" choose the option "Load device software (Firmware) ...". From here the DRIVEMANAGER will guide you through the other work steps. LEDs H2 and H3 will light during transfer of the Firmware. After successful transfer the LED H2 will go out, if no ENPO signal is applied.

1

2

3

4

5

6

7

8

A

2.7 Device protection

Function	Effect
<ul style="list-style-type: none"> Protection of the positioning controller against damage caused by overload. 	<p>The positioning controller stops the motor with an error message.</p> <ul style="list-style-type: none"> E-OTI, if the device temperature exceeds a fixed limit E-OLI, if the integrated current time value exceeds the limit value set in dependence on the power module by a certain triggering time E-OC when detecting short circuit or earth fault The positioning controller can submit a warning when the I²xt-device protection integrator is started

The software and hardware of the positioning controller automatically takes over the monitoring and protection of the device.

The power stage protects itself against overheating in dependence on

- the heat sink temperature,
- the applied d.c. link voltage,
- the transistor modules used in the power stages and
- the modulation switching frequency



Note: The current heat sink temperature of the positioning controller in the area of the power transistors (KTEMP) and the internal device temperature (DTEMP) are displayed in °C (see chapter 6.8.2).

Under high loads the I²xt-integrator is activated. The I²xt monitoring serves the purpose of protecting the device against permanent overloads. The switch-off limit is calculated on the basis of rated current and the overload ability of the controller.

Device	Switch-off limit I ² xt device
CDB32.003 (0,375 kW) to CDB34.032 (15 kW) CDE32.003 (2,4 A) to CDE34.032 (32 A)	1,8 x Rated device current for 30 s
CDB34.044 (22 kW) to CDB34.168 (90 kW)	1,5 x Rated device current for 60 s
CDE34.044 (45 A) to CDB34.168 (170 A)	2,0 x Rated device current for 3 s
CDF3000 (8 A)	2,0 x Rated device current for 30 s

Table 2.23 Switch-off limits I²xt acc. to device size

With active I²xt integrator the warning message can be submitted to a digital output, field bus or PLC.

The hardware of the positioning controller will detect a short circuit at the motor output and switch off the motor.

Short circuit



Info: Detailed information on permissible current load for the positioning controllers can be taken from the operating instructions.

3 Operation structure

- 3.1 Operation levels in the parameter structure3-2**
- 3.2 Operation with DRIVEMANAGER3-4**
 - 3.2.1 Operation masks3-5
- 3.3 Operation with KP200-XL operation panel3-9**
- 3.4 Commissioning3-14**

Due to the use of different operation variants and extensive possibilities for parameterization the operation structure is very flexible. The well organized data structure thus supports the handling of data and the parameterization of the positioning controllers.

Parameterization of the positioning controllers may take place via the easy to use hand-held KP200-XL operation panel or the comfortable PC user interface DRIVEMANAGER.

3.1 Operation levels in the parameter structure

With adjustable parameters the positioning controllers can be adapted to any application. For the internal values of the positioning controllers there are further parameters available, which are password protected for reasons of operating safety.

The operation levels are adjusted by means of parameters. The number of editable and displayable parameters changes in dependence on the operation level. The higher the operation level, the higher the number of parameters with access rights. In contrast, the clarity of the parameters actually needed by the user to reach his application as quickly as possible, is reduced. This means that operation is remarkably easier when choosing the lowest possible operation level.



Note: The operation levels protect against unauthorized access. Thus the operation level 01-MODE = 2 is activated about 10 minutes after last activation of the button when using the KP200-XL operation panel.

Changing the operation level

If a higher operation level is selected via parameter 01-MODE, the associated password is automatically requested. This password can be changed by means of a password editor (setting "000" = password disabled).

Target group	Password parameter	Comment	Operation level 01-MODE	Password in WE ¹⁾
Layman	no parameter available	without access right, only for status monitoring <ul style="list-style-type: none"> no parameterization, display of basic parameters 	1	-
Beginner	362-PSW2	with basic knowledge for minimum operation <ul style="list-style-type: none"> extended basic parameters editable extended parameter display 	2	000
Advanced	363-PSW3	for commissioning and field bus connection <ul style="list-style-type: none"> Parameterization for standard applications extended parameter display 	3	000
Expert	364-PSW4	with expert knowledge in control technology <ul style="list-style-type: none"> all closed loop control parameters editable extended parameter display 	4	000
Others	365-PSW5	for system integrators	5	-
Expert personnel	367-PSWCT	Operation and start-up using the KP200-XL operation panel	CTRL menu	573

¹⁾ WE = Factory setting

Table 3.1 Setting operation levels

If a password is set up for operation level 2 ... 4, both viewing and editing of parameters in the corresponding operation level by means of the KP200-XL operation panel is maintained, until a change to a lower operation level. For this purpose a new operation level must be selected via parameter 01-MODE.

Changing the password for an operation level

A password can only be changed via levels with operation rights, i.e. passwords of a higher operation level cannot be changed or viewed. A password is changed by selecting the parameter, editing and finally saving the password by pressing the Enter-key on the KP200-XL operation panel. This change can also be made via DRIVEMANAGER. The password will only become active when changing to a lower operation level.

Changing the operation level in DRIVEMANAGER

The corresponding level is selected in menu option "Extras - Select new user level".



Changing levels does not require a password.

3.2 Operation with DRIVEMANAGER

Connection and start

- Connect the interface cable and switch on the power supply for the positioning controller.
- After the program start the DRIVEMANAGER will automatically set up a link to the connected controller (minimum V2.3).
- If the automatic connection does not work, check the setting in the menu **Extras > Options** and set up the connection with the Icon

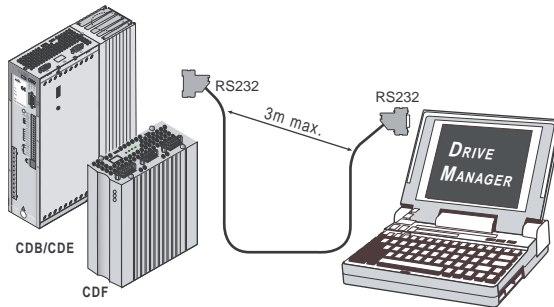

Fig. 3.1 Connection via RS232 interface cable (9-pin, socket/pins)

The most important functions



Further information can be found in the help to the DRIVEMANAGER.

Icon	Function	Menu
	Connect to the device	Communication > Connect > Single device
	Changing the device settings	Active device > Change settings
	Print parameter data set	Active device > Print settings
	Control drive	Active device > Control > Basic operation modes, no position setpoints
	Digital Scope	Active device > Monitor > Quickly changing digital scope values
	Saving settings from device to file	Active device > Save settings of device to

Icon	Function	Menu
	Load settings from file into device	Active device > Load settings into device from
	Bus initialization (change settings)	Communication > Bus configuration
	Disconnect the link to the device	Communication > Disconnect
	Compare device settings	Active device > Compare settings



Note: Further information can be found in the operating instructions for the DRIVEMANAGER.

3.2.1 Operation



Via ICON "CHANGE DEVICE SETTINGS" or via menu:

Active device > Change settings

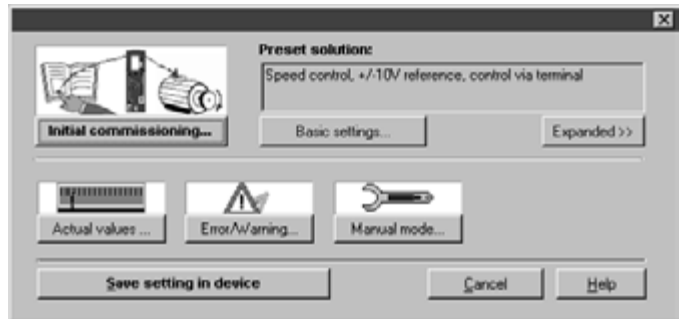

Fig. 3.2 Adjustment in minimized view

This operation mask "Settings" can be used to parameterize the position controllers.

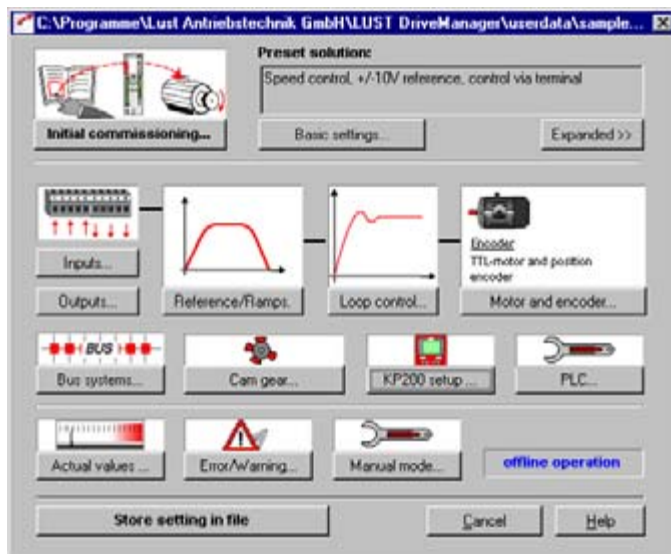

Fig. 3.3 Adjustment in extended view



Note: Parameter changes only take place in the volatile random access memory and must subsequently be saved in the device by pressing the button "**Save device settings**". The same is achieved by simultaneous pressing of both arrow keys on the KP200-XL operation panel for approx. 2 seconds in menu level (see chapter 3.3).

Example Operation via mask

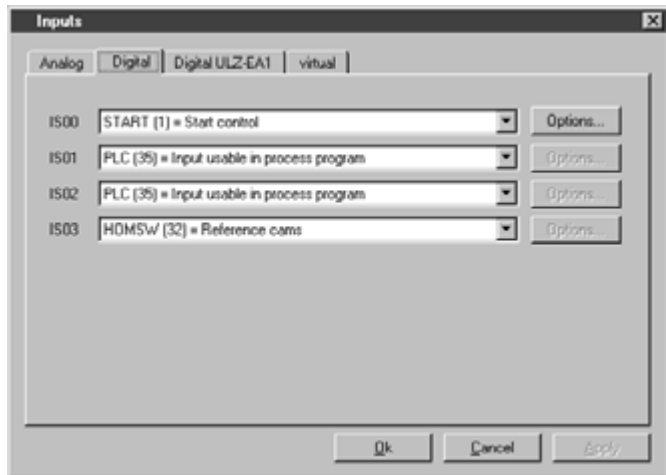

Fig. 3.4 Example for operation via mask

Function of buttons

- OK → Accept changes and close mask
- Cancel → Cancel changes and close mask
- Accept → Accept changes (activate) and keep mask open.
- Options → Optional settings for the corresponding function

Explanation of setting

for example:

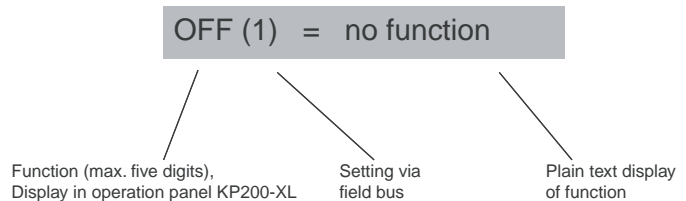

Help function:

In any input window key **F1** can be used to call up a help function with further information on the corresponding parameter.

e.g. the mask "Function selector analog standard input

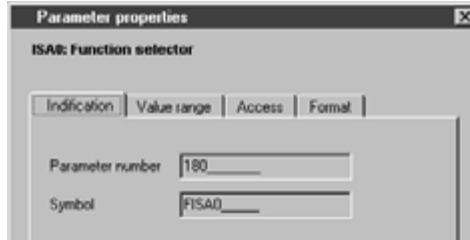

Fig. 3.5 Identification

Parameter number: Number of parameter

Abbreviation: Name, max. five digits (display in KP200-XL)

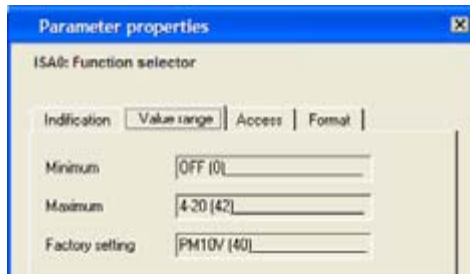

Fig. 3.6 Value range

Minimum/Maximum: Value range (here: between OFF and /E-EX).

Factory setting: After a device reset to factory setting (WE) this value is automatically entered.

3.3 Operation with KP200-XL operation panel

Installation and connection of the operation panel

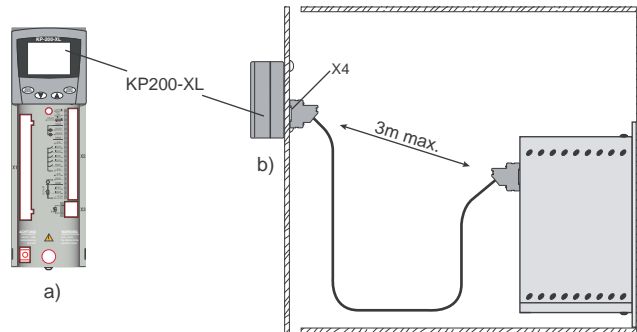
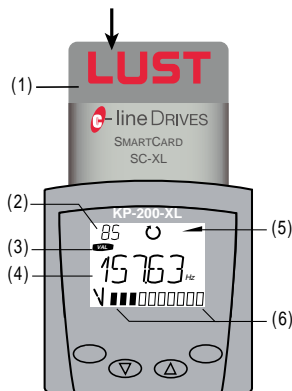

Fig. 3.7 Installation of the operation panel: a) on the positioning controller (plug X4) for CDE/CDB3000 or b) on the control cabinet door



Note: Connection to the positioning controller CDF3000 is always accomplished via interface cable to board slot X4.

Control and display elements



- (1) Chip card SMARTCARD to save and transfer settings
- (2) 3-digit numerical display, e. g. for parameter number,
- (3) current menu
- (4) 5-digit numerical display for parameter name and value
- (5) Acceleration and deceleration ramp active
- (6) Bar graph display, 10-digit



Call up menu branches or parameters; save changes;
Control start in drive



Quit menu branches; Cancel changes; Control stop in drive



Select menu, subject area or parameter; Increase setting



Select menu, subject area or parameter; Reduce setting

Fig. 3.8 Control and display elements of the operation panel KP200-XL

Menu structure

The KP200-XL operation panel has a menu structure for clearly arranged operation

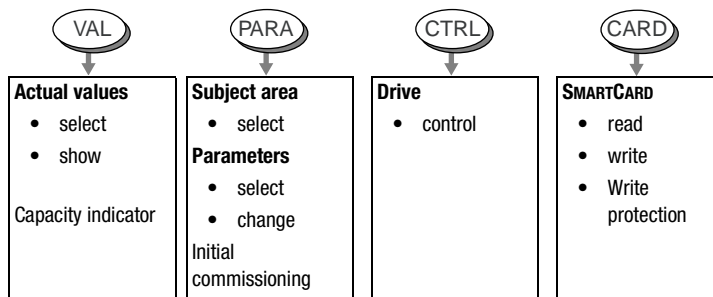

Fig. 3.9 Menu functions

In the menu level (display "MENU") one can use the arrow keys to change between menus. The **Start/Enter**-key opens a menu, the **Stop/Return**-key closes the menu.

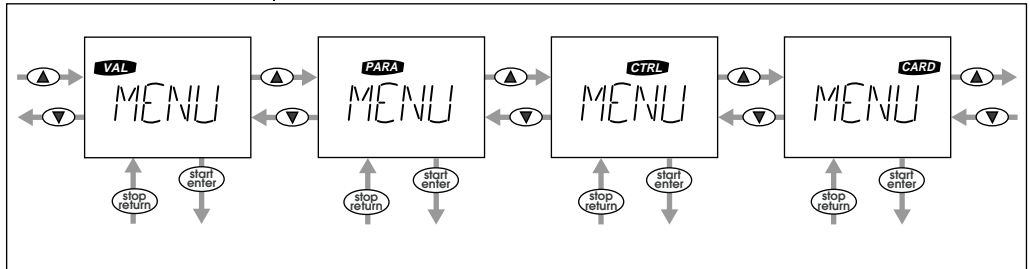

Fig. 3.10 Navigating through the menu level



Note: Parameter changes in the menu branch "PARA" only take place in the volatile random access memory and must subsequently be permanently saved to the read-only memory. In menu level this can be simply accomplished by simultaneous pressing of both arrow keys for approx. 2 seconds.

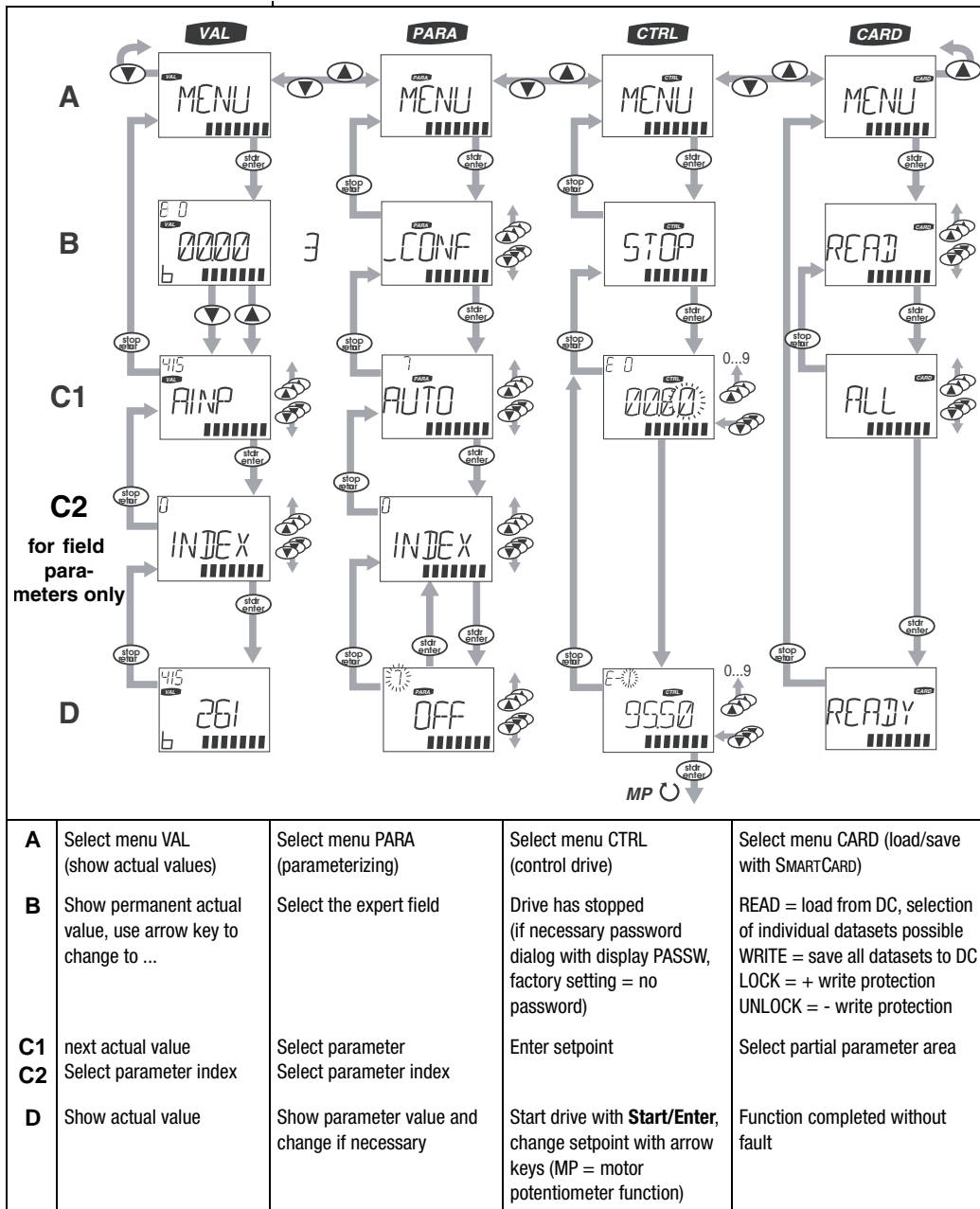

Table 3.2 Menu structure of the KP200-XL operation panel at a glance

Value display in exponential representation

The representation of the five-digit numerical display for parameter values uses the exponential notation. The setpoint specification in the CTRL-menu is likewise specified and displayed using the exponential notation.

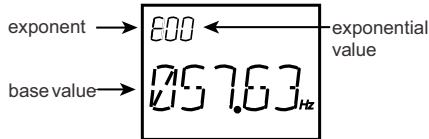

Fig. 3.11 Exponential representation in the KP200-XL display

The exponential representation makes work easier when considering the exponential value a "Decimal point displacement factor".

Exponential value	Decimal point displacement direction in base value
positive	to the right \Rightarrow value increases
negative	to the left \Rightarrow value decreases

Table 3.3 Exponential value as "Decimal point displacement factor"

In the base value the decimal point is displaced by the number of digits corresponding with the exponential value.

Example:

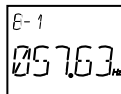

Decimal point displacement by one digit to the left
 $\Rightarrow 57.63 \cdot 10^{-1} \text{ Hz} = 5.763 \text{ Hz}$



Decimal point displacement by two digits to the right
 $\Rightarrow 57.63 \cdot 10^2 \text{ Hz} = 5763 \text{ Hz}$

SMARTCARDS

SMARTCARDS are created in dependence on the firmware of the positioning controllers. In case of a firmware extension within the scope of a new device software version the extensions are automatically written to the SMARTCARD when saving ("WRITE"). SMARTCARDS are thus always upward compatible.



Note: SMARTCARDS can only be read by the positioning controller type (e.g. CDB3000) they have been written by.

3.4 Commissioning

Commissioning procedure by following the user manual

1. Initial commissioning by following the operating instructions:



Prerequisite is the general initial commissioning by following the operating instructions.

The user manual solely deals with the adaptation of the software functions.

If the settings made during initial commissioning by following the operating instructions are not sufficient for the application:

2. Selecting the optimal pre-set solution



The pre-set solutions cover the typical applications for the positioning controllers.

The dataset most appropriate for the application is selected.

3. Individual adaptation of the preset solution to the application.



The pre-set solution serves as initial point for an application related adaptation. Further function related adaptations are made to the parameters in the function oriented subject areas. Save your settings in the unit!

4. Check the settings of the application solution



With respect to the safety of man and machine the application solution should only be checked at low rotary speeds. The correct sense of rotation must be assured. In events of emergency can be stopped by disconnecting the ENPO-signal and thus blocking the controller output stage.

5. Completion of commissioning



After successful commissioning save your settings (with SMARTCARD or DRIVEMANAGER) and memorize the data set in the unit.

4 CDE/CDB/CDF3000 in rotary speed operation

4.1	Preset solutions	4-2
4.2	General functions	4-3
4.2.1	Torque / rotary speed profile generator	4-3
4.2.2	Limitations/Stop ramps	4-5
4.3	Torque control with reference value via analog input	4-6
4.4	Speed control with reference value via analog input	4-6
4.5	Speed control with reference value from fixed speed table	4-7
4.6	Speed control with reference value and control via field bus	4-9
4.6.1	CANopen	4-9
4.6.2	PROFIBUS	4-10
4.7	Speed control with reference value via PLC	4-10
4.8	Assignment of control terminal	4-10
4.8.1	Terminal assignment CDE3000	4-11
4.8.2	Terminal assignment CDB3000	4-12
4.8.3	Terminal assignment CDF3000	4-13

4.1 Preset solutions

Pre-set solutions are complete parameter datasets which are provided to handle a wide variety of typical application movement tasks. The positioning controllers are automatically configured by setting a preset solution. The parameters for

- the control location of the positioning controller,
- the reference source,
- the assignment of signal processing input and outputs and
- the type of control

are the focal points of the setting.

The use of a pre-set solution considerably simplifies and shortens the commissioning of the positioning controller. By changing individual parameters, the preset solutions can be adapted to the needs of the specific task.

A total of eleven preset solutions covers the typical areas of application for torque/speed control with the closed-loop controllers.

Abbreviation	Reference source	Control location/ Bus control profile	Chapt .	Additionally required documentation
TCT_1	±10V analog torque	I/O-terminals	4.8.2	
SCT_1	+/-10V-analog	I/O-terminals	4.8.2	
SCT_2	Fixed speed table	I/O-terminals	4.5	
SCC_2	Fixed speed table	CAN _{open} field bus interface - EasyDrive-Profile "Basic"	4.5	CAN _{open} data transfer protocol
SCB_2	Fixed speed table	Field bus module CM-DPV1 - EasyDrive-Profile "Basic"	4.5	PROFIBUS data transfer protocol
SCC_3	CAN _{open} field bus interface	CAN _{open} field bus interface - EasyDrive-Profile "Basic"	4.6	CAN _{open} data transfer protocol
SCB_3	Field bus communication module (PROFIBUS)	Field bus module CM-DPV1 - EasyDrive-Profile "Basic"	4.6	PROFIBUS data transfer protocol
SCP_3	PLC	PLC	4.7	see chapter 7
SCT_4	PLC	I/O-terminals	4.7	see chapter 7
SCC_4	PLC	CAN _{open} field bus interface - EasyDrive-Profile "ProgPos"	4.7	CAN _{open} data transfer protocol
SCB_4	PLC	Field bus module CM-DPV1 - EasyDrive-Profile "ProgPos"	4.7	PROFIBUS data transfer protocol

Table 4.1 Preset solutions - in rotary speed operation

All pre-set solutions have an individual window for basic settings in DRIVEMANAGER. Tabs or control buttons contained therein differ in their general and special functions. The general functions are described in chapter 4.2, the special functions in the corresponding pre-settings from chapter 4.4 to 4.7.

4.2 General functions

4.2.1 Torque / rotary speed profile generator

The rotary speed profile generator generates the corresponding acceleration and deceleration ramps required to achieve the specified speed reference value.

The parameter MPTYP (linear/jerk limited) and JTIME can be used to slip linear ramps at their end points to limit the appearance of jerks.

Type of movement	Setting
dynamic, jerky	MPTYP = 0, linear ramp without slip
Protecting mechanics	MPTYP = 3, smoothed ramp by slip by JTIME [ms].

Table 4.2 Activation of the jerk limitation

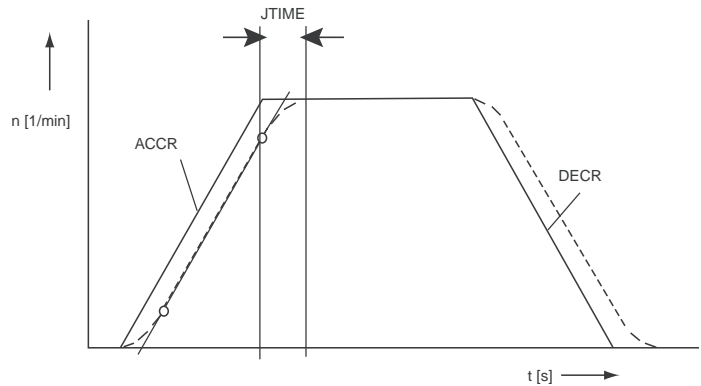

Fig. 4.1 Rotary speed profile generator

Due to the jerk limitation the acceleration and deceleration times rise by the slip time JTIME. The rotary speed profile is set in the DRIVEMANAGER according to Fig. 4.2.

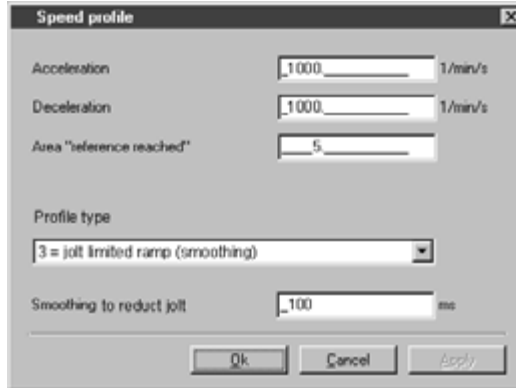

Fig. 4.2 Rotary speed profile

DRIVEMANAGER	Value range	WE	Unit	Parameters
Acceleration (only for speed control)	0 ... 32760	0	min ⁻¹ /s	590_ACCR (_SRAM)
Deceleration (only for speed control)	0 ... 32760	0	min ⁻¹ /s	591_DECR (_SRAM)
Area "Reference reached"	0 ... 32760	20	min ⁻¹	230_REF_R (_OUT)
Type of profile 0: Linear ramp 3: Jerk limited ramp 1, 2: not supported	0 ... 3	3	-	597_MPTYP (_SRAM)
Slip	0 ... 2000	100	ms	596_JTIME (_SRAM)



Note: In torque control mode no acceleration and deceleration ramps are active. Only the slip time remains analogically valid, i.e. it generates ramp shaped reference torque courses.

Parameter 230-REF_R can be used to define a speed range in which the actual value may differ from the reference value, without the message "Reference value reached" (REF) becomes inactive. Reference value fluctuations caused by reference value specification via analog inputs can therefore be taken into account.

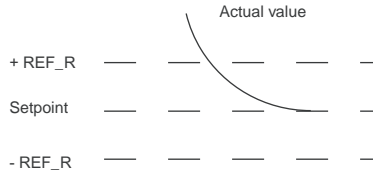

Ramp settings can be made independently from each other. A ramp setting of zero means jump in reference value.

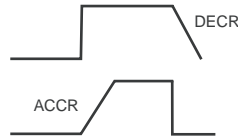

4.2.2 Limitations/ Stop ramps

These functions are described in the general software functions in chapters 6.2.2 (limitations) and 6.2.3 (stop ramps).

Limitations are adjustable for:

- torque
- rotary speed

Various stop ramps or reactions can be adjusted:

- switching off of closed-loop control
- stop feed
- quick stop
- Error

4.3 Torque control with reference value via analog input

With the preset solution TCT_1 the scalable torque reference value is specified via the analog input ISA0. The parameter settings for the analog input are described in chapter 6.1.3, the specific settings of inputs and outputs in chapter 4.8.

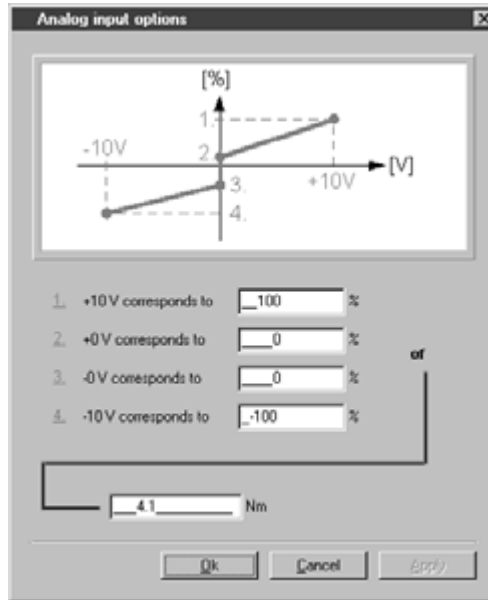

Fig. 4.3 Setting the torque control

4.4 Speed control with reference value via analog input

With the preset solution SCT_1 the scalable rotary speed reference value is specified via the analog input ISA0. The parameter settings for the analog input are described in chapter 6.1.3, the specific settings of inputs and outputs in chapter 4.8.

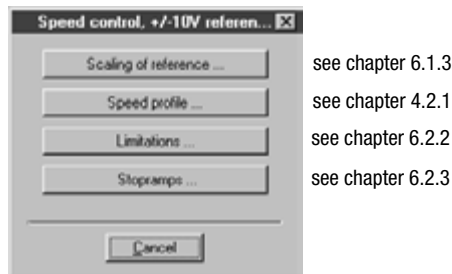

Fig. 4.4 Basic setting "Speed control, +/-10V reference value"

4.5 Speed control with reference value from fixed speed table

The fixed speed table is the reference source for the preset solutions SCT_2, SCC_2 and SCB_2. There are 16 travel sets (0-15) to be entered via the mask "Fixed speeds" from Fig. 4.6. The specific settings of inputs and outputs for the control locations via I/O-terminals (SCT_2), CANopen (SCC_2) or PROFIBUS (SCB_2) are described in chapter 4.8.



see chapter 4.2.1

see chapter 6.2.2

see chapter 6.2.3

Fig. 4.5 Basic setting "Speed control, fixed speeds"

Table of fixed speeds



Fig. 4.6 Mask "Fixed speeds"

DRIVEMANAGER	Value range	WE	Unit	Parameters
Rotary speed	-32764.0 ... 32764.0	0.0	min ⁻¹	269.x-RTAB (_RTAB) x = fixed speed 0-15



Note: The rotary speed profile is the same for all fixed speed. The realization of a variable speed profile in dependence on the speed can be realized with a PLC-program; for an example please refer to chapter 7.5.4.

Selection of fixed speed

Fixed speeds can be selected via terminal or field bus (Profile EasyDrive "Basic"). The number of the active fixed speed is indicated by a parameter, and, binary coded, via the outputs (if parameterized).

The inputs planned for fixed speed selection are configured with Flxxx = TABx. The selection is binary coded.

The binary valence (2^0 , 2^1 , 2^2 , 2^3) results from the TABx-assignment. The setting TAB0 thereby has the lowest (2^0), the setting TAB3 the highest valence (2^3). A logic-1-level at the input activates the valence. Changing the status of the terminal activates a new fixed speed.

Example:

IE07	IE06	IE05	IE04	IE03	IE02	IE01	IE00	IS03	IS02	IS01	IS00	Selectable travel sets
	TAB3 = 2^3	TAB2 = 2^2	TAB1 = 2^1	TAB0 = 2^0								0-15
			TAB1 = 2^1			TAB0 = 2^0				TAB3 = 2^3		0-3, 8-11

Table 4.3 Example for the fixed speed selection via terminal

The following parameters are used to select or display the active travel set:

DRIVEMANAGER	Meaning	Value range	WE	Unit	Parameters
-	Selection of travel set fixed speed This parameter describes the selection via inputs. Field bus: Selection of a tabular set	0 - 15	0	-	278-TIDX (_RTAB)
-	Display parameter Shows the currently selected fixed speed.	0-15	0	-	776-ATIDX (_RTAB)

With the STOP-Logics (feed enable) (terminal or bus) a progressing movement can be stopped and restarted by application of the programmed speed profile.

4.6 Speed control with reference value and control via field bus

With the preset solutions SCC_3 and SCB_3 the field bus is preset as source for reference values. The specific settings on inputs and outputs for the control locations CAN_{open} (SCC_3) and PROFIBUS (SCB_3) are described in chapter 4.8.

The reference value specification for the speed control is either accomplished via the device internal CAN_{open} field bus interface (SCC_3), or via the PROFIBUS communication module (SCB_3).

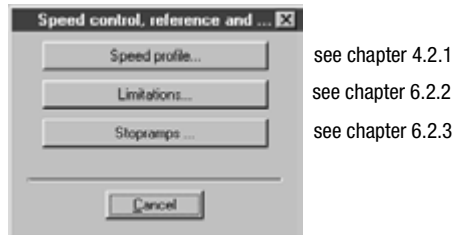

Fig. 4.7 Basic setting "Speed control, reference values and control via bus"

4.6.1 CAN_{open}



The drive controllers are integrated into the automation network via the device internal electrically isolated CAN_{open} interface X5.

Communication takes place in accordance with profile DS301. Control and target position specification is in accordance with the proprietary EasyDrive profile "Basic".

Note: If a speed control in compliance with DSP402 is demanded, the **Profile-Velocity-Mode** must be used for to regulate the speed of the drive. This mode is a special form of positioning. Please choose the presetting "PCC_1-Positioning, travel set specification and control via CAN-Bus".

Detailed information on configuration of the drive controller in the network can be found in the separate documentation "CAN_{open} data transfer protocol".

4.6.2 PROFIBUS

The speed specification and control via PROFIBUS requires the external communication module CM-DPV1.

Control and speed specification is in accordance with the EasyDrive profile "Basic".

Detailed information on configuration of the drive controller in a network can be found in the separate documentation "PROFIBUS data transfer protocol".

4.7 Speed control with reference value via PLC

For the preset solutions SCP_3, SCT_4 SCC_4 and SCB_4 the PLC is preset as source of reference values. The specific settings for control locations I/O-terminals (SCT_4), CAN_{open} (SCC_4) and PROFIBUS (SCB_4) are described in chapter 4.8.

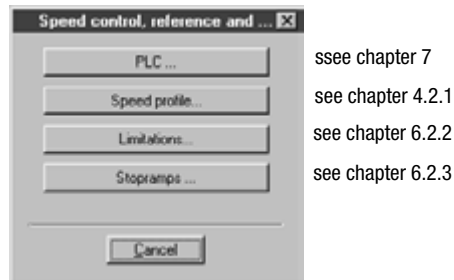

Fig. 4.8 Basic setting "Speed control with PLC"

With these presettings the speed reference value is specified by means of the command SET REFVAL = [x]. If the control location has also been set to PLC (SCP_3), the command SET ENCTRL = 0/1 can be used to switch the control off or on.



Note: Detailed information on handling the PLC as well as programming and operation with the PLC editor see chapter 7 "User programming".

4.8 Assignment of control terminal

The control terminal for the speed control is configured in dependence on the chosen preset solution.

4.8.1 Terminal assignment CDE3000

Depending on the selected presetting the parameterization of inputs and outputs differs from the factory setting, see Table 4.4. After selecting the presetting the parameterization of the terminals can be adapted to the application as desired.

I/O	Parameters	Function	Pre-set solution							
			TCT_1	SCT_1 (WE)	SCT_2	SCC_2 SCB_2	SCC_3 SCB_3	SCP_3	SCT_4	SCC_4 SCB_4
ISA0	180-FISA0	Function selector analog standard input ISA0+		PM10V	OFF	OFF	OFF	PLC	PLC	PLC
ISA1	181-FISA1	Function selector analog standard input ISA1+		OFF				PLC	PLC	PLC
ISD00	210-FIS00	Function selector digital standard input ISD00		START		OFF	OFF	PLC	PLC	PLC
ISD01	211-FIS01	Function selector digital standard input ISD01		OFF	INV			PLC	PLC	PLC
ISD02	212-FIS02	Function selector digital standard input ISD02		OFF	TAB0			PLC	PLC	PLC
ISD03	213-FIS03	Function selector digital standard input ISD03		OFF	TAB1			PLC	PLC	PLC
ISD04		Function selector digital standard input ISD04		OFF	TAB2			PLC	PLC	PLC
ISD05		Function selector digital standard input ISD05		OFF	TAB3			PLC	PLC	PLC
ISD06		Function selector digital standard input ISD06		OFF				PLC	PLC	PLC
OSD00	240-FOS00	Function selector digital standard input OSD00		REF						
OSD01	241-FOS01	Function selector digital standard input OSD01		ROT_0						
OSD02	242-FOS02	Function selector digital standard input OSD02		S_RDY						
OSD03		Function selector digital standard input OSD03		OFF						

Table 4.4

Presetting the control inputs and outputs in speed controlled operation of the CDE3000

4.8.2 Terminal assignment CDB3000

Depending on the selected presetting the parameterization of inputs and outputs differs from the factory setting, see Table 4.5. After selecting the presetting the parameterization of the terminals can be adapted to the application as desired.

I/O	Parameters	Function	Pre-set solution						
			TCT_1 SCT_1 (WE)	SCT_2	SCC_2 SCB_2	SCC_3 SCB_3	SCP_3	SCT_4	SCC_4 SCB_4
ISA00	180-FISA0	Function selector analog standard input ISA00	PM10V	OFF	OFF	OFF	PLC	PLC	PLC
ISA01	181-FISA1	Function selector analog standard input ISA01	OFF				PLC	PLC	PLC
ISD00	210-FIS00	Function selector digital standard input ISD00	START		OFF	OFF	PLC		PLC
ISD01	211-FIS01	Function selector digital standard input ISD01	OFF				PLC	PLC	PLC
ISD02	212-FIS02	Function selector digital standard input ISD02	OFF	TAB0			PLC	PLC	PLC
ISD03	213-FIS03	Function selector digital standard input ISD03	OFF	TAB1			PLC	PLC	PLC
OSA00	200-FOSA0	Function selector for analog output OSA00	ACTN				PLC	PLC	PLC
OSD00	240-FOS00	Function selector digital standard input OSD00	REF						
OSD01	241-FOS01	Function selector digital standard input OSD01	ROT_0						
OSD02	242-FOS02	Function selector digital standard input OSD02	S_RDY						

Table 4.5 Presetting of the control inputs and outputs with speed control

4.8.3 Terminal assignment CDF3000

Depending on the selected presetting the parameterization of inputs and outputs differs from the factory setting, see Table 4.6. After selecting the presetting the parameterization of the terminals can be adapted to the application as desired.

I/O	Parameters	Function	Pre-set solution							
			TCT_1	SCT_1 (WE)	SCT_2	SCC_2 SCB_2	SCC_3 SCB_3	SCP_3	SCT_4	SCC_4 SCB_4
ISA0	180-FISA0	Function selector analog standard input ISA0+		PM10V	OFF	OFF	OFF	PLC	PLC	PLC
ISA1	181-FISA1	Function selector analog standard input ISA1+		OFF				PLC	PLC	PLC
ISD00	210-FIS00	Function selector digital standard input ISD00		START		OFF	OFF	PLC	PLC	PLC
ISD01	211-FIS01	Function selector digital standard input ISD01		OFF	INV			PLC	PLC	PLC
ISD02	212-FIS02	Function selector digital standard input ISD02		OFF	TAB0			PLC	PLC	PLC
OSD00	240-FOS00	Function selector digital standard input OSD00		REF						
OSD01	241-FOS01	Function selector digital standard input OSD01		ROT_0						
OSD02	242-FOS02	Function selector digital standard input OSD02		S_RDY						

Table 4.6 *Presetting the control inputs and outputs in speed controlled operation of the CDF3000*

5 CDE/CDB/CDF3000 in positioning operation

5.1	Pre-set solutions	5-2
5.2	General functions	5-4
5.2.1	Positioning modes	5-5
5.2.2	Units and standardization	5-6
5.2.3	Travel profile	5-9
5.2.4	Referencing	5-13
5.2.5	Limit switch	5-25
5.2.6	Manual operation / Jog mode	5-26
5.3	Positioning with table travel sets	5-28
5.3.1	Travel set selection	5-28
5.3.2	Sequence of travel set selection with follow-up order logic	5-30
5.3.3	Parameterization of the travel set table	5-32
5.3.4	Switching points	5-37
5.3.5	Teach in	5-39
5.4	Positioning and control via field bus	5-40
5.4.1	CANopen	5-40
5.4.2	PROFIBUS	5-40
5.5	Positioning with PLC	5-41
5.6	Assignment of control terminal	5-41
5.6.1	Terminal assignment CDE3000	5-42
5.6.2	Terminal assignment CDB3000	5-43
5.6.3	Terminal assignment CDF3000	5-44

5.1 Pre-set solutions

Pre-set solutions are complete parameter data sets which are provided to handle a wide variety of typical application movement tasks.

The position controllers are automatically configured by loading a pre-set solution into the random access memory (RAM). The parameters for

- the control location of the drive controller,
- the reference source,
- the assignment of signal processing input and outputs and
- the type of control

are the focal points of the setting.

The use of a pre-set solution considerably simplifies and shortens the commissioning of the positioning controller. By changing individual parameters, the preset solutions can be adapted to the needs of the specific task. These modified pre-set solutions are saved in the device as customized datasets. In this way, you can arrive more rapidly at your desired movement solution.

A total of nine preset solutions covers the typical areas of application for positioning with the closed-loop controllers.

Abbreviation	Reference source	Control location/ Bus control profile	Chapt.	Additionally required Documentation
PCT_2	Tabular travel set	I/O-terminals	5.3	-
PCC_2	Tabular travel set	CAN _{open} field bus interface - EasyDrive Profile "TabPos"	5.3	CAN _{open} data transfer protocol
PCB_2	Tabular travel set	Field bus communication module (PROFIBUS) - EasyDrive Profile "TabPos"	5.3	PROFIBUS data transfer protocol
PCC_1	CAN _{open} field bus interface	CAN _{open} field bus interface - DSP402-Profiles position mode - DSP402-Profiles velocity mode	5.4	CAN _{open} data transfer protocol
PCB_1	Field bus communication module (PROFIBUS)	Field bus communication module (PROFIBUS) - EasyDrive-Profile "DirectPos"	5.4	PROFIBUS data transfer protocol
PCP_1	PLC	PLC	5.5	see chapter 7
PCT_3	PLC	I/O-terminals	5.5	see chapter 7
PCC_3	PLC	CAN _{open} field bus interface - EasyDrive-Profile "ProgPos"	5.5	CAN _{open} data transfer protocol
PCB_3	PLC	Field bus communication module (PROFIBUS) - EasyDrive-Profile "ProgPos"	5.5	PROFIBUS data transfer protocol

Table 5.1 Preset solutions for positioning

All pre-set solutions have an individual window for basic settings in DRIVEMANAGER. Tabs contained therein differ in their general and special functions. The general functions are listed in chapter 5.2.

The special functions, i. e. the reference source for the respective presettings, are described in chapter 5.3 to 5.5.

Chapter 5.6 defines the characteristics of the control location or the device control including the terminal assignment.



Note: After selection of the preset solution the units and standardization of the drive must first be adjusted, as described in chapter 5.2.2. These are the basic requirements for the settings following thereafter.

1

2

3

4

5

6

7

8

A

5.2 General functions



Activating the function button "Basic Settings" in DRIVEMANAGER opens the following window:

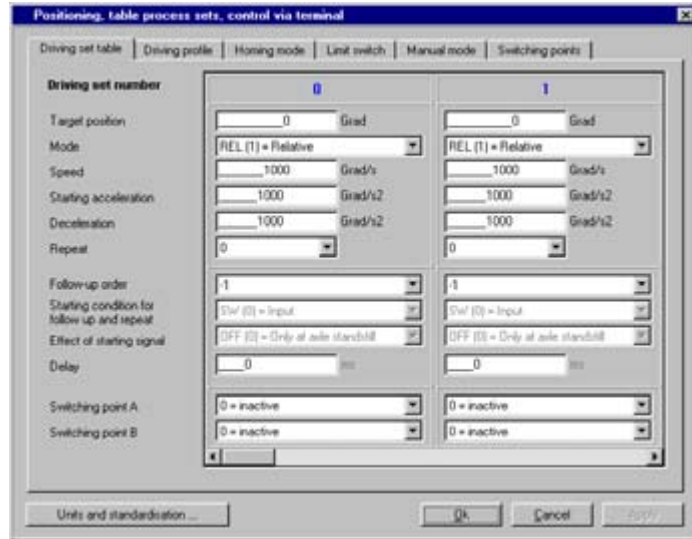

Fig. 5.1 Preset solution "Positioning, Travel set tables, control via terminal"

This chapter describes the types of positioning and the functions (control buttons and tabs):

- Units and standardization
- Travel profile
- Referencing
- Limit switch
- Manual operation

5.2.1 Positioning modes

Positioning is sub-divided into three different modes:

Positioning mode	Meaning
ABSOLUTE	The positioning application requires an absolute reference position (zero). This position is either generated by referencing or by means of a position measuring system measuring absolute values. An absolute distance is travelled with respect to this reference position.
RELATIVE	<p>Relative travel tasks refer to the last target position, even if this position has not yet been reached, e. g. when triggered during a progressing positioning process. A new target position is thus calculated on the following basis:</p> $\text{Target position (new)} = \text{Target position (old)} + \text{relative distance}$ <p>Exceptions:</p> <ul style="list-style-type: none"> - Terminating an endless travel task with a relative travel task. - Releasing a follow-up task in the table of travel sets with the effect "NEXT - Immediately, Rel.-Bez. ActPos." <p>Here the relative distance refers to the actual position at the time of release. A new target position is thus calculated on the following basis:</p> $\text{Target position (new)} = \text{Actual position} + \text{relative distance}$ <p>Relative positioning processes do not require a reference point or no reference travel.</p>
ENDLESS	<p>For endless travel tasks the drive is moved with the specified speed (speed mode). A target position contained in this travel set is of no meaning.</p> <p>Table travel sets releasing a follow-up task with the start condition "WSTP - Without stop from target position" are also endless travel tasks. However, these are cancelled at the specified travel position and transferred to the follow-up order.</p> <p>An endless travel task can only be terminated with a new travel task. Absolute travel tasks approach the new target position directly. Relative travel tasks refer to the actual position at the time of release.</p> <p>Endless positioning processes do not require a reference point or no reference travel.</p> <p>Endless positioning can be used to realize a speed control or online switching between positioning and speed control. The CAN_{open} Profile DSP402 "Profile Velocity Mode" is a form of endless positioning.</p>

Table 5.2 Types of positioning

5.2.2 Units and standardization



Note: After selection of the preset solution the units and standardization of the drive must first be adjusted. These are the basic requirements for the settings following thereafter. These settings can be made through the DRIVEMANAGER.



Units

For positioning the units for position, speed and acceleration can be set. If not specified differently all positioning parameters are based on these units. The following base units can be set:

- Translatory unit: m
- Rotary units: Degree, rev, rad, sec, min
- Special units: Incr, Steps
- Units with user defined text (max. 20 characters): User

The time basis for the speed is automatically set to [Exp*Path unit]/s, the one for acceleration to [Exp*Path unit]/s².

All parameters are integer values. Floating point settings are not possible. For the input of a value lower than 1 (<1) of the base unit the exponent must additionally be set. Base unit (e. g. [m]) and exponent (e. g. E-2) thus determine the resulting unit (z. B. [cm]).

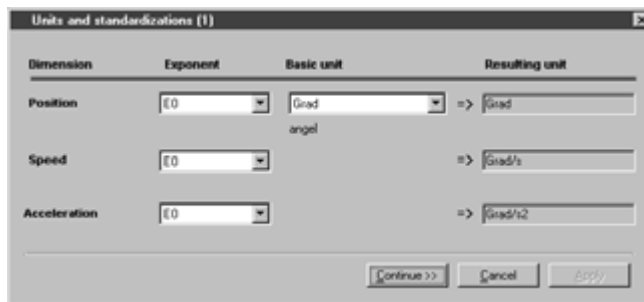

Fig. 5.2 Specification of units

The parameter for the resulting unit is:

DRIVEMANAGER	Value range	WE	Unit	Parameters
Position	-	Degree	variable	792_FGPUN (_FG)

DRIVEMANAGER	Value range	WE	Unit	Parameters
Speed	-	Degree/s	variable	793_FGVUN (_FG)
Acceleration	-	Degree/s ²	variable	796_FGAUN (_FG)

After determining the units the input continues with the mechanical drive values.

2.

Continue >>

Feed constant and gear factor

The feed constant converts the specified path units into output shaft revolutions. Furthermore, the gear transmission ratio can be entered as a fraction. This ensures that the output shaft position is always converted to the motor shaft without any rounding errors.

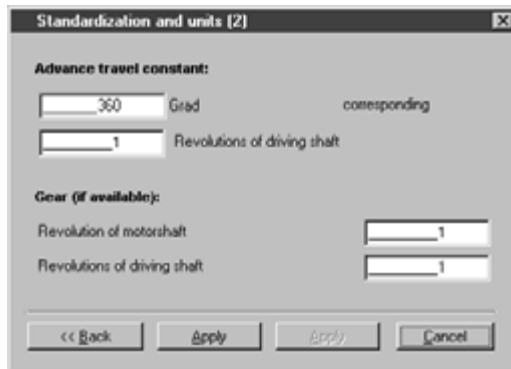

Fig. 5.3 Settings for units and standardization

DRIVEMANAGER	Value range	WE	Unit	Parameters
Feed constant / Path for n revolutions	0 ... 4294967295	360	variable	789.0_FGFC (_FG)
Feed constant / Output shaft revolutions	0 ... 4294967295	1	-	789.1_FGFC (_FG)
Gear/ Motor shaft revolution	0 ... 4294967295	1	-	788.0_FGGR (_FG)
Gear/ Output shaft revolutions	0 ... 4294967295	1	-	788.1_FGGR (_FG)

Ready

After the input of parameters the settings are checked by pressing "Ready". Pressing the "Return" button brings you back to the input of units.

3

Checking the settings

The settings for units and standardization are checked for plausibility and device internal value ranges and accepted.

In very few cases the following message will appear:



Fig. 5.4 Error message caused by collision

In this case value ranges or standardizations collided in the closed-loop control. The units and standardization assistant now suggests a different power or exponent for the unit and will ask you to check, accept or change this in the units window, which is directly opened upon acknowledgement. Accepting the new setting also adapts the feed constant.

5.2.3 Travel profile

This mask is used to configure the limit values for the travel set, the profile form and the travel range. The units have already been determined, see chapter 5.2.2.

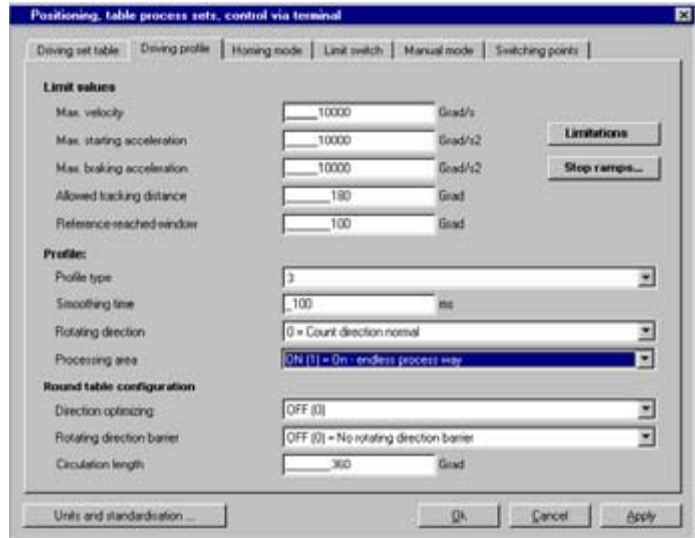

Fig. 5.5 Travel profile

Limit values:

DRIVEMANAGER	Meaning	Value range	WE	Unit	Parameters
Max. speed	Maximum speed of travel set. All speeds are limited to this value.	0 ... 4294967295	10000	variable	724_POSMX (_PRAM)
Max. start-up acceleration	Max. start-up acceleration of the positioning set	0 ... 4294967295	10000	variable	722_POACC (_PRAM)
Max. braking acceleration	Max. braking acceleration of the positioning set	0 ... 4294967295	10000	variable	723_PODEC (_PRAM)
Permissible trailing distance	Max. difference between positioning reference and actual value of the profile generator An error reaction E-FLW will be executed when exceeding (see chapter 6.9).	0 ... 4294967295	180	variable	757_PODMX (_PBAS)
"Reference reached" window	Hysteresis for the target position to display the status "Target position reached". If the actual position is in this window, the status will be set to 1.	0 ... 4294967295	100	variable	758_POWIN (_PBAS)

Table 5.3 Basic settings for travel profile

The buttons "Limitations" and "Stop ramps" are described under the general software functions in chapters 6.2.2 (Limitations) and 6.2.3 (Stop ramps).

Limitations are adjustable for:

- torque
- rotary speed

Stop ramps or their reactions are adjustable for:

- switching off of closed-loop control
- stop feed
- quick stop
- Error

Speed override

In positioning the travel speed can be scaled online. The speed override function with a possible scaling range from 0% - 150% of the travel speed serves this function.

The override is set by means of the volatile parameter POOVR.

Function	Value range	WE	Data types	Parameters
Speed override	0 ... 150 %	100 %	usign8 (RAM)	753-POOVR (_PBAS)

The override function is activated by:

- Changing the parameter 753-POOVR, e. g. via field bus
- Analog input FISA1 = SCALE.
The analog value is written directly to parameter 753-POOVR.
Manual changing of 753-POOVR is of no effect in this case.
- PROFIBUS EasyDrive control word "DirectPos".
The transmitted value is set directly to parameter 753-POOVR.
Manual changing of 753-POOVR is of no effect in this case.

Profile

DRIVEMANAGER	Meaning	Value range	WE	Unit	Parameters
Type of profile	0: Linear acceleration profile, i.e. no jerk limitation 3: Jerk limited acceleration profile with programmed slip time 596-JTIME 1,2: no function	0 - 3	3	-	597-MPTYP (_SRAM)
Slip time with jerk limitation	The acceleration and deceleration time increases by the slip time. A jerk limitation is thus achieved.	0 - 2000	100	ms	596-JTIME (SRAM)
Sense of rotation	0: Normal - positive position values = clockwise rotation of motor 1: No function	0 / 1	0	-	795-FGPOL (_FG)
Travel range	OFF (0): Off - limited travel path, e.g. for linear axes ON (1): On - endless travel path, e.g. for round axes Definition of a circulation length is required. For the round table configuration further adjustment possibilities must be implemented.	OFF / ON	OFF		773-PORTA (_PBAS)

Endless travel path - round table configuration

With an endless travel range, frequently referred to as round table, further detailed settings are possible. All travel paths are in this case calculated on a range $0 \leq \text{travel path} < \text{circulation length}$.

DRIVEMANAGER	Meaning	Value range	WE	Parameters
Direction optimization	OFF (0): Switched off ON (1): Switched on Further explanations see below	OFF... ON	OFF	775_PODOP (_PBAS)
Reversing lock	OFF (0): No reversing lock POS (1.): Positive sense of rotation locked NEG (2): Negative sense of rotation locked Further explanations see below	OFF ... NEG	OFF	308_DLOCK (_CTRL)
Circulation length	The circulation length specifies the position range. Thereafter (in case of overrun) the system starts at 0 again.	0 ... 4294967295	360	774_PONAR (_PBAS)

Direction optimization

With direction optimization activated an absolute target is always approached over the shortest possible distance. Relative movements do not take place in a path optimized way.

Examples for a circulation length of 360°, actual position of 0° and absolute positioning:

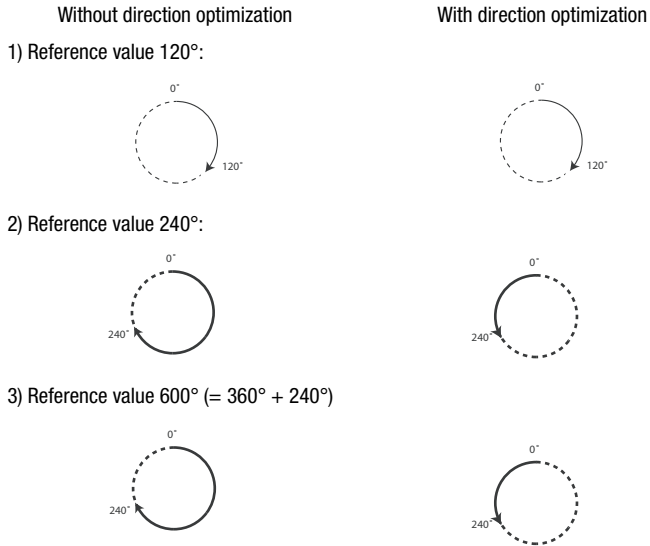

Table 5.4 Examples for a circulation length of 360°

Reversing lock

In a round table configuration a reversing lock always has priority. If the negative sense of rotation was locked in the previous examples, the system would always move in positive direction, even if the direction optimization was active.

Behaviour of absolute travel tasks

Absolute travel tasks are divided into three sections, depending on their target position.

Travel range	Effect
Target position < circulation length	The drive approaches the specified target position.
Target position = circulation length	The drive will stop.
Target position > circulation length	<p>Within the range of the circulation length the drive travels to the "Target position - (n x circulation length)".</p> <p>$n = \text{integer proportion of target position/circulation length}$</p> <p>Example: Circulation length=360°, absolute target position=800° $n = 800°/360° = 2,222$ Target position = 80° = 800° - 2 x 360°</p>

Table 5.5 Endless travel range - behaviour of absolute travel tasks

Behaviour of relative travel tasks

Relative travel tasks always refer to the last target position, even if this position has not yet been reached, e. g. when triggered during a progressing positioning process.

With relative travel tasks paths longer than the circulation length are possible, if the target position exceeds the circulation length.

Example:

Circulation length = 360°; relative target position = 800°, start position = 0°

The drive performs two complete revolutions (720°) and stops during the 3rd revolution at 80° (800° - 720°).

Behaviour of endless travel tasks

For endless travel tasks the drive is moved with the specified speed (speed mode). A target position contained in this travel set is of no meaning. Table travel sets releasing a follow-up task with the start condition "WSTP - Without stop from target position" are also endless travel tasks. However, these are cancelled at the specified travel position and transferred to the follow-up order.

Endless travel tasks run with specified speed, irrespective of the circulation length. When switching to the next travel set (absolute or relative) the system moves to the new target position in the present travel direction. An active direction optimization is thereby neglected.

Behaviour in case of travel set changes during progressing positioning

The travel task is changed while positioning is in progress. If, in this case, the drive does not stop at the new target position, e. g. because of a too long deceleration time, the drive will overshoot and return to the target position.

If the reversing lock is in this case active the drive will brake to speed 0, accelerate again with the defined travel profile and continue in travel direction to the target position.

In case of overshooting a set path optimization is neglected.

5.2.4 Referencing

Referencing is performed to generate an absolute position reference (related to the entire axis) and must normally be performed once after switching on the mains supply. Referencing is required when running absolute positioning processes without an absolute encoder (e. g. SSI-Multiturn-Encoder). All other positioning procedures (relative, endless) do not require referencing. For zeroizing with absolute encoders referencing type -5 is available.

There are 41 different types, which can be set as required by the application.

By selecting the referencing (type -5 to 35) and determining the setting

- the reference signal (positive limit switch, negative limit switch, reference cam)
- the travel direction of the drive and
- the position of the zero pulse

can be defined. The referencing sequence corresponds with the graphically displayed referencing type.

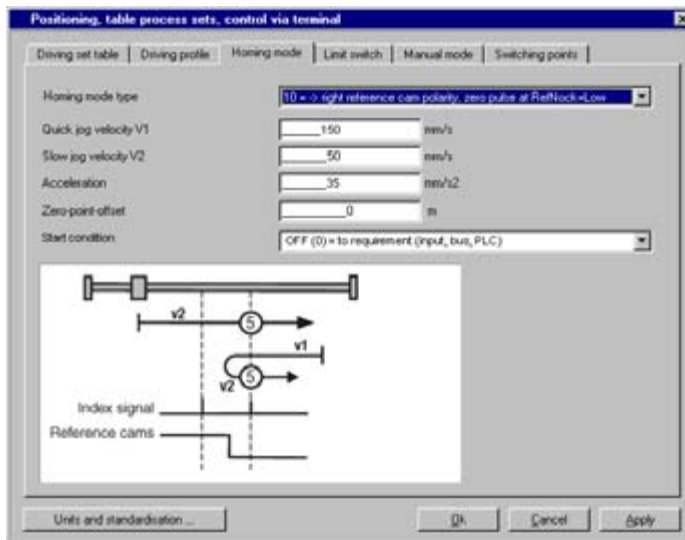

Fig. 5.6 Selection window for referencing

DRIVEMANAGER	Meaning	Value range	WE	Unit	Parameters
Referencing type	The referencing type specifies the event required to set the reference point. Further explanations see below.	-5 ... 35	-1		730_HOMDT (_HOM)
Rapid motion speed V1	Referencing speed to the first referencing event (reference cam, zero pulse)	0 ... 4294967295	20	Degree/s	727_HOSPD (_HOM)
Creep speed V2	Referencing speed from the first event for slow approaching of the referencing position	0 ... 4294967295	20	Degree/s	727_HOSPD (_HOM)
Acceleration	Acceleration during the entire referencing process	0 ... 4294967295	10	Degree/s ²	728_HOACC (_HOM)
Zero point offset	The reference point is always set with the zero point offset.	-2147483648 ... 2147483647	0	Degree	729_HOOFF (_HOM)
Start condition	Start condition for referencing. Further explanations see below.	OFF ... TBEN	OFF		731_HOAUT (_HOM)

Table 5.6 Settings for referencing

Start of referencing

The start conditions can be programmed.

BUS	Setting	Effect
0	OFF	Referencing is requested via: - field bus (DSP402-Homing mode or EasyDrive control word), level triggered (1- referencing On, 0- referencing Off) - Terminal (ISxx=HOMST, flank triggered 0->1) - PLC (command GO 0, flank triggered) Referencing is started with every request.
1	AUTO	Referencing is automatically started once when initially starting the control. No further referencing takes place if the referencing conditions remain unchanged for other starts of the control.
2	TBEN	Only valid when positioning with table travel sets. Referencing is automatically performed once when initially selecting a travel set. No further referencing takes place if the referencing conditions remain unchanged for other travel set selections.

Table 5.7 Referencing start conditions

Referencing type

The following describes the different types. The individual reference points, which correspond with the zero point, are numbered in the graphs. The different speeds (V1-rapid motion, V2-creep speed) and the movement directions are also shown.

The four signals for the reference signal are:

- Negative (left) hardware limit switch
- Positive (right) hardware limit switch
- Reference cams
- Index signal of the encoder

In referencing the absolute encoders (e. g. SSI-Multiturn-Encoder) are a special feature, because they directly create an absolute relation to the position. Referencing with these encoders therefore does not require any movement and, under certain conditions, energizing of the drive may also not be necessary. However, adjustment of the zero point is still necessary. The type -5 is particularly suitable for this purpose.



Type -5, absolute encoder

This type is particularly suitable for absolute encoders (e.g. SSI-Multiturn-Encoder). Referencing takes place immediately after switching the mains supply on, which means that it can also be activated in de-energized state.

The current position complies with the zero point. The zero position is calculated on basis of the absolute encoder position + zero point offset.

According to this, referencing with zero point offset = 0 supplies the absolute position of the SSI-encoder, e.g. in operation of a SSI-Multiturn-Encoder. Another referencing with unchanged setting of the zero point offset does not cause a change in position.

Referencing or zero point adjustment for the system must be performed as follows

1. Enter zero point offset = 0
2. Referencing (start referencing) delivers the absolute position of the sensor
3. Move drive to reference position (zero point of machine)
4. At this point enter the zero point offset (the value by which the position is to be changed with respect to the displayed position)
5. Repeat referencing (start referencing)
6. Save the setting (zero point offset)
7. The system will be automatically referenced when switching the mains supply on. Manual referencing is no longer necessary.

Like referencing type 22, with subsequent possibility of continuous referencing. Further explanations under "Type -3".

Type -4, continuous referencing, neg. reference cams

Like referencing type 20, with subsequent possibility of continuous referencing.

Type -3, continuous referencing, pos. reference cams

Types "-3" and "-4" can only be used with endless travel range (773-PORTA=ON). They serve the fully automatic compensation of slippage or inaccurate transmission ratio. After initial referencing the actual position is overwritten with the zero point offset at every rising flank of the reference cam. The path still to be travelled is corrected, the axis is thus able to perform any number of relative movements to one direction without drifting off, even with drives susceptible for slippage.

The circulation length (774-PONAR) must come as close as possible to the path between two reference signals. With other words: E.g., the same position must be indicated after one circulation, as otherwise disturbing movements may occur during a correction. The permissible trailing distance (757-PODMX) must be bigger than the maximum mechanical inaccuracy.



Attention: The correction of the actual position takes place in form of jumps. No acceleration ramps are active. The correction is this dealt with like a trailing error compensation. The maximum speed during the correction process can be adjusted under the function "Limitations" (see chapter 6.2.2). Here the maximum speed of the positioning travel profile is not active.

Type -2, no referencing

No referencing is performed. The zero point offset is added to the current position. During initial switching on of the power stage the status "referencing completed" is set.

Type -1, actual position = 0

This type is most suitable for absolute encoders, as long as no zeroizing is required. For zeroizing you should select type -5.

Type 0

The actual position corresponds with the zero point, it is set to 0, i. e. the closed-loop control runs a actual position reset. The zero point offset is added.

Type 1, negative limit switch and index signal

Not defined.

The initial movement takes place according to Fig. 5.7 in direction of the negative (left) hardware limit switch (this switch is inactive) and the direction of movement is reversed with active flank. The first index signal after the descending flank corresponds with the zero point.

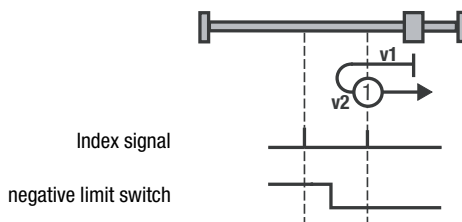

Fig. 5.7 *Type 1, negative limit switch and index signal*

Type 2, negative limit switch and index signal

The initial movement takes place according to Fig. 5.8 in direction of the positive (right) hardware limit switch (this switch is inactive) and the direction of movement is reversed with active flank. The first index signal after the descending flank corresponds with the zero point.

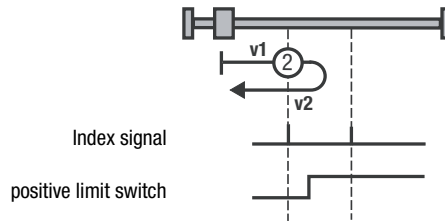

Fig. 5.8 Type 2, negative limit switch and index signal

Type 3+4, positive limit switch and index signal

The initial movement takes place according to Fig. 5.9 in direction of the positive (right) hardware limit switch, if the reference cam is inactive, see symbol A in Fig. 5.9.

As soon as the reference cam becomes active, the direction of movement will be reversed for type 3.

The first index signal after the descending flank corresponds with the zero point. For type 4 the first index signal after the ascending flank corresponds with the zero point.

The initial movement takes place in direction of the negative (left) hardware limit switch and the reference cam is active, see symbol B in Fig. 5.9.

If the reference cam becomes inactive, the first index signal of type 3 will correspond with the zero point. With type 4 the movement direction will change as soon as the reference cam becomes inactive. The first index signal after the ascending flank corresponds with the zero point.

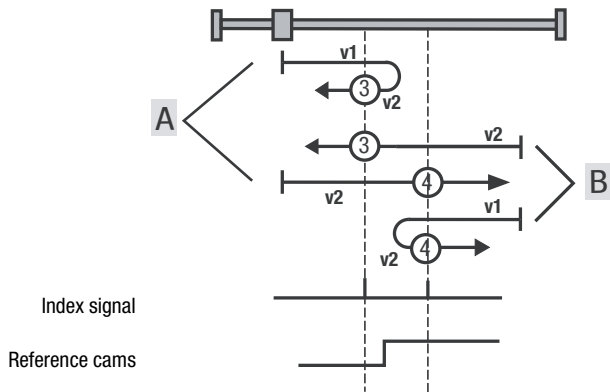

Fig. 5.9 Type 3+4, positive limit switch and index signal

Type 5+6, negative limit switch and index signal

The initial movement takes place in direction of the positive (right) hardware limit switch and the reference cam is active, see symbol A in Fig. 5.10.

For type 5 the first index signal after the descending flank corresponds with the zero point. When the reference cam becomes inactive, the direction of movement with type 6 will be reversed and the first index signal after the ascending flank corresponds with the zero point.

The initial movement takes place in direction of the negative (left) hardware limit switch and the reference cam is inactive, see symbol B in Fig. 5.10.

With type 5 the direction of movement is reversed as soon as the reference cam becomes active, and the first index signal after the descending flank corresponds with the zero point. For type 6 the first index signal after the ascending flank corresponds with the zero point.

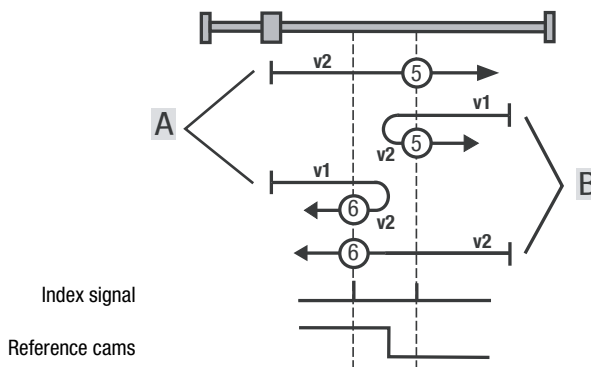

Fig. 5.10 Type 5+6, negative limit switch and index signal

Type 7 to 10, reference cams, index signal and positive limit switch

The initial movement is in direction of the positive (right) hardware limit switch. Limit switch and reference cam are inactive, see symbol A in Fig. 5.11.

Type 7 changes the direction of movement after the active reference cam. The first index signal after the descending flank corresponds with the zero point. With type 8 the zero point corresponds with the first index signal with active reference cam. Type 9 changes the direction of movement, if the reference cam has been overtravelled. The zero point corresponds with the first index signal after the ascending flank. With type 10 the reference cam is overtravelled and the first index signal after this corresponds with the zero point.

The initial movement is in direction of the negative (left) hardware limit switch. The positive limit switch is inactive and the reference cam is active, see symbol B in Fig. 5.11.

With type 7 the zero point corresponds with the first index signal after descending flank of the reference cam. Type 8 changes the direction of movement after descending flank of the reference cam. The zero point corresponds with the first index signal after the ascending flank of the reference cam.

The initial movement is in direction of the positive (right) hardware limit switch. The limit switch is inactive and the reference cam is active, see symbol C in Fig. 5.11.

Type 9 changes the direction of movement, if the reference cam is inactive. The zero point corresponds with the first index signal after the ascending flank. With type 10 the first index signal is the zero point after descending flank of the reference cam.

The initial movement is in direction of the positive (right) hardware limit switch. Limit switch and reference cam are active. As soon as the positive limit switch becomes active the direction of movement will change, see symbol D in Fig. 5.11.

With type 7 the first index signal after overtravelling the reference cam corresponds with the zero point.

Type 8 changes the direction of movement, if the reference cam has been overtravelled. The zero point corresponds with the first index signal after the ascending flank. With type 9 the zero point corresponds with the first index signal with active reference cam. Type 10 changes the direction of movement after the active reference cam. The first index signal after the descending flank corresponds with the zero point.

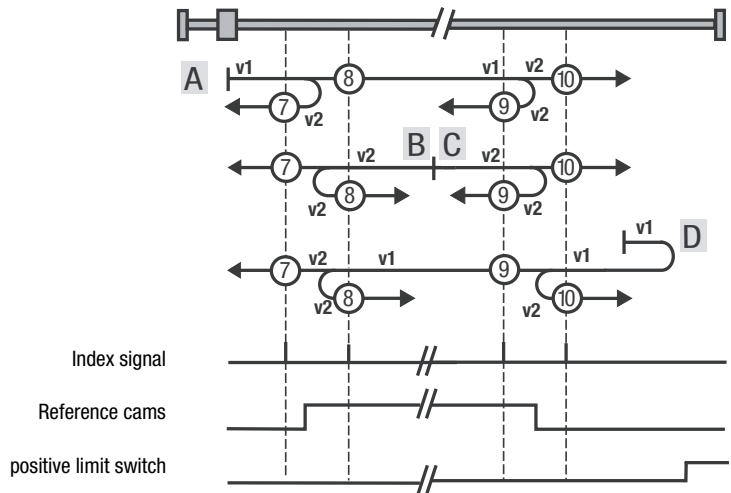

Fig. 5.11 Type 7 to 10, reference cams, index signal and positive limit switch

Type 11 to 14, reference cams, index signal and negative limit switch

The initial movement is in direction of the negative (left) hardware limit switch. Limit switch and reference cam are inactive, see symbol A in Fig. 5.12.

Type 11 changes the direction of movement after the active reference cam. The first index signal after the descending flank corresponds with the zero point. With type 12 the zero point corresponds with the first index signal with active reference cam.

Type 13 changes the direction of movement, if the reference cam has been overtravelled. The zero point corresponds with the first index signal after the ascending flank.

With type 14 the reference cam is overtravelled and the first index signal after this corresponds with the zero point.

The initial movement is in direction of the negative (left) hardware limit switch. The limit switch is inactive and the reference cam is active, see symbol B in Fig. 5.12.

Type 13 changes the direction of movement, if the reference cam is inactive. The zero point corresponds with the first index signal after the ascending flank. With type 14 the first index signal is the zero point after descending flank of the reference cam.

The initial movement is in direction of the positive (right) hardware limit switch. The negative limit switch is inactive and the reference cam is active, see symbol C in Fig. 5.12.

With type 11 the zero point corresponds with the first index signal after descending flank of the reference cam. Type 12 changes the direction of movement after descending flank of the reference cam. The zero point corresponds with the first index signal after the ascending flank of the reference cam.

The initial movement is in direction of the negative (left) hardware limit switch. Limit switch and reference cam are active. As soon as the negative limit switch becomes active the direction of movement will change, see symbol D in Fig. 5.12.

With type 11 the reference cam must be overtravelled, so that the first index signal corresponds with the zero point.

Type 12 changes the direction of movement, if the reference cam has been overtravelled. The zero point corresponds with the first index signal after the ascending flank.

With type 13 the zero point corresponds with the first index signal with active reference cam.

Type 14 changes the direction of movement after the active reference cam. The first index signal after the descending flank corresponds with the zero point.

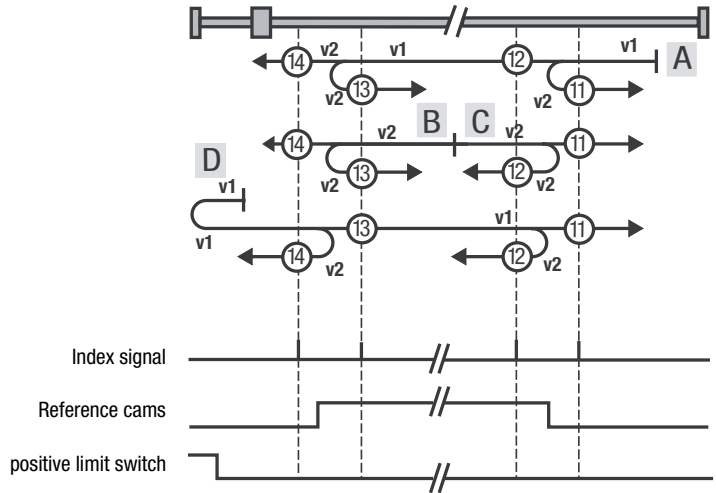

Fig. 5.12 Type 11 to 14, reference cams, index signal and negative limit switch

Type 15 and 16

Type 17 to 30, reference cams

These types of referencing are not defined.

Referencing types 17 to 30 are similar to types 1 to 14. The zero point determination does not depend on the index signal, but solely on the reference cams or the limit switches.

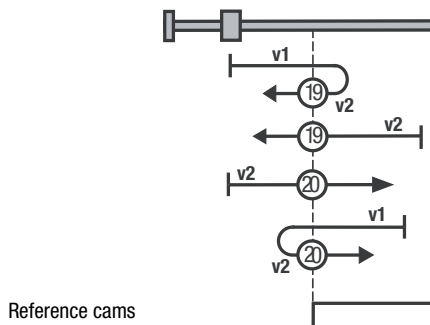

Fig. 5.13 Type 17 to 30, reference cams

Type 1	analog	Type 17
	:	
Type 4	analog	Type 20
	:	
Type 8	analog	Type 24
	:	
Type 12	analog	Type 28
	:	
Type 14	analog	Type 30

Table 5.8 Type analogy for the individual types of referencing

Type 31 and 32

Type 33 and 34, index signal

These types of referencing are not defined.

The zero point corresponds with the first index signal in direction of movement.

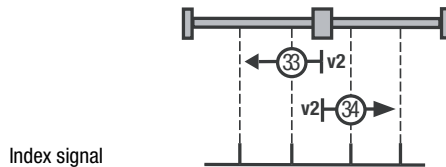

Index signal

Fig. 5.14 Type 33 and 34, index signal

Type 35

The current position complies with the zero point. No reset is performed.

5.2.5 Limit switch

Software limit switch

The software limit switches are only valid for positioning. They only become active after successful referencing.

The software limit switches are only activated by identical setting (limit switch+ = limit switch- = 0).



DRIVEMANAGER	Meaning	Value range	WE	Unit	Parameters
Positive	Software limit switch in positive sense of rotation	-2147483648 ... 2147483647	0	variable	759-SWLSP (_PBAS)
Negative	Software limit switch in negative sense of rotation	-2147483648 ... 2147483647	0	variable	760-SWLSN (_PBAS)

The behaviour or reaction depends on the parameterized fault reaction (see chapter 6.9) and the positioning mode.

Positioning mode	Behaviour/reaction
Absolute	Before releasing an absolute travel task the system will check whether the target is in the valid range, meaning inside the range of the software limit switches. If the target is outside the limits no travel order will be submitted and the programmed fault reaction acc. to 543-R-SWL will be performed.
Relative	
Endless (speed controlled)	The drive moves until a software limit switch is detected. After this the programmed fault reaction acc. to 543-R-SWL is performed. A rapid stop is also performed with reactions of R-SWL=NOERR or WARN

Table 5.9 Behaviour of the software limit switches

5.2.6 Manual operation / Jog mode

Hardware limit switch

The hardware limit switches are valid for all types of closed-loop control. They are connected via drive controller inputs. For this purpose two inputs must be set up as described in chapter 6.1.1.

Manual operation/Jog mode is only valid for positioning. With jog mode activated the drive is operated in speed controlled mode (endless).

For manual operation two different jog speeds can be set. These can be activated via the window DRIVEMANAGER Manual operation or via terminal and field bus. This activation requires that the drive is stopped.

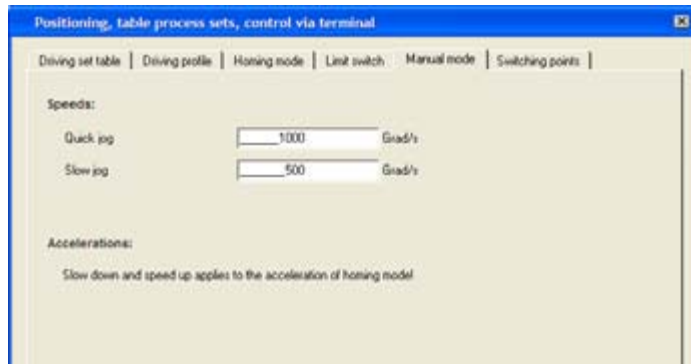

DRIVEMANAGER	Value range	WE	Unit	Parameters
Speed Rapid motion	0 ...4294967295	1000	variable	721_VQJOG (_PRAM)
Speed Creep speed	0 ...4294967295	500	variable	720_VSJOE (_PRAM)

Jog mode via terminal or field bus

In jog mode the drive is controlled by means of two signals or inputs, either in positive or negative direction. If one of these signals becomes active while the control is active, the drive will move with creep speed. Rapid motion is activated by operating the second jog input also in creep speed status. If the first signal is deactivated in rapid motion, the drive will stop. If it is set again, the drive will again move with creep speed, even if rapid motion had been requested. An example for a jog sequence in positive travel direction is shown in Table 5.10.

Ser.-No.	Signal TIPP	Signal TIPN	Status of axis
1.	0	0	Standstill
2.	1	0	Creep speed
3.	1	1	Rapid motion
4.	0	1	Standstill
5.	1	1	Creep speed
6.	1	0	Creep speed
7.	1	1	Rapid motion
8.	1	0	Creep speed
9.	0	0	Standstill

Table 5.10 Example jog operation in positive direction

5.3 Positioning with table travel sets

For the preset solutions PCT_2, PCC_2 and PCB_2 the travel set table is preset as setpoint source. The specific settings of the control via I/O-terminals or field bus are described in chapter 5.6. If the drive is controlled via field bus, the special proprietary EasyDrive protocol "TablePos" is used.

There are 16 travel sets (0-15). A travel set consists of:

1. Target position
2. Mode for absolute/relative/endless positioning
3. Speed
4. Start-up acceleration
5. Braking deceleration
6. Repetition of a relative travel set
7. Follow-up order logics with various provisional conditions. Follow-up orders enable the realization of small automated sequence programs.
8. Travel set dependent switching points, see chapter 5.3.4

A slip time in ms programmed in the travel profile serves as jerk limitation. It applies for all travel sets. The travel sets can only be set via the PC desktop DRIVEMANAGER or field bus.



Note: The travel sets have the predefined standard units. Before parameterizing the travel sets you must therefore first set the units and the standardization, see chapter see chapter 5.2.2.

5.3.1 Travel set selection

Travel sets can be selected and activated via terminal or field bus. The number of the active travel set is indicated by a parameter, and, binary coded, via the outputs (if parameterized).

The inputs planned for travel set selection are configured with Flxxx = TABx, see example in Table 5.11. The selection is binary coded.

The binary valence (2^0 , 2^1 , 2^2 , 2^3) results from the TABx-assignment. The setting TAB0 thereby has the lowest (2^0), the setting TAB3 the highest valence (2^3). A logic-1-level at the input activates the valence.

Example:

IE07	IE06	IE05	IE04	IE03	IE02	IE01	IE00	IS03	IS02	IS01	IS00	Selectable travel sets
	TAB3 = 2 ³	TAB2 = 2 ²	TAB1 = 2 ¹	TAB0 = 2 ⁰								0-15
					TAB2 = 2 ²		TAB1 = 2 ¹				TAB0 = 2 ⁰	0-7
			TAB1 = 2 ¹			TAB0 = 2 ⁰				TAB3 = 2 ³		0-3, 8-11

Table 5.11 Example for the travel set selection via terminal

A separate release signal (see Table 5.12) via an input or the field bus (trigger) is required to activate a travel set via terminal. The selection of a new table index and thus a new travel task will interrupt the ongoing positioning process or the follow-up order logic.

Control location	Signal	Comment
I/O-terminal	Input Flxxx = TBEN	Release of selected travel set The selection of a new table index and thus a new travel task will always interrupt the ongoing positioning process or the follow-up order logic.
	Input Flxxx = FOSW	Next start Effect like "TBEN", if a follow-up order is started but no follow-up order is available or waiting. FOSW will then start the next selected travel set.
Field bus	Bit "Perform travel task"	Release of selected travel set The selection of a new table index and thus a new travel task will always interrupt the ongoing positioning process or the follow-up order logic.
	Bit "Repetition/perform follow-up order"	Next start Effect like bit "Perform follow-up task", if a follow-up order is started but no follow-up order is available or waiting. FOSW will then start the next selected travel set.

Table 5.12 Release signal for new travel set

The following parameters are used to select or display the active travel set:

DRIVEMANAGER	Meaning	Value range	WE	Unit	Parameters
-	Travel set selection. This parameter describes the selection via inputs.	0 - 15	0	-	278-TIDX (_RTAB)
-	Display parameter Shows the currently processed travel set.	0-15	0	-	776-ATIDX (_RTAB)

With the HALT-Logic (Enable feed) (terminal or bus) a progressing positioning can be interrupted either with the programmed or the quick stop ramp (see chapter 6.2.3) and subsequently continued again.

5.3.2 Sequence of travel set selection with follow-up order logic

The sequence of travel set editing is prioritized:

1. Execution of the selected travel set
2. Execution of repetition with relative travel sets
Repetitions are performed with parameterizable start conditions. The start conditions are identical with the ones of the follow up order.
3. Jump to the next travel set
The follow-up order is performed with parameterizable start conditions. The start conditions are identical with the ones for the repetitions.

Activation of a travel set always interrupts this sequence.

This sequence is shown in Fig. 5.15

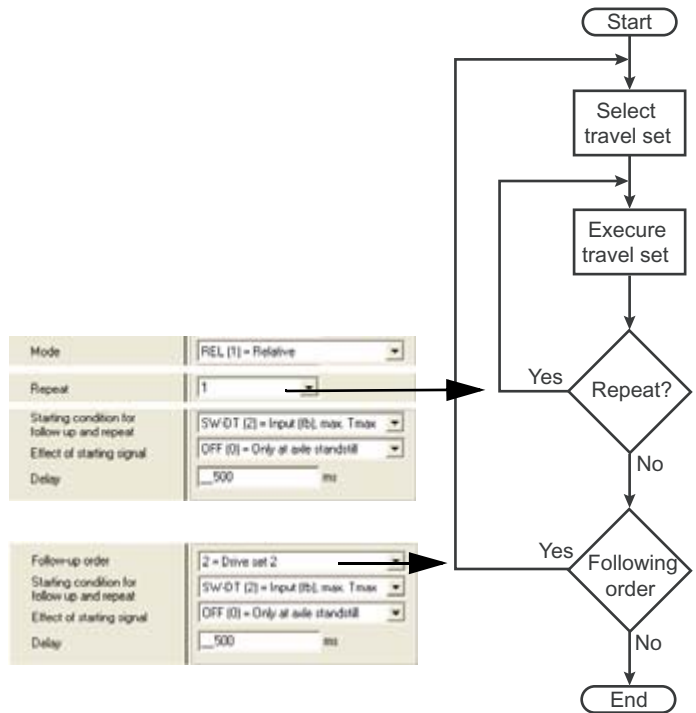
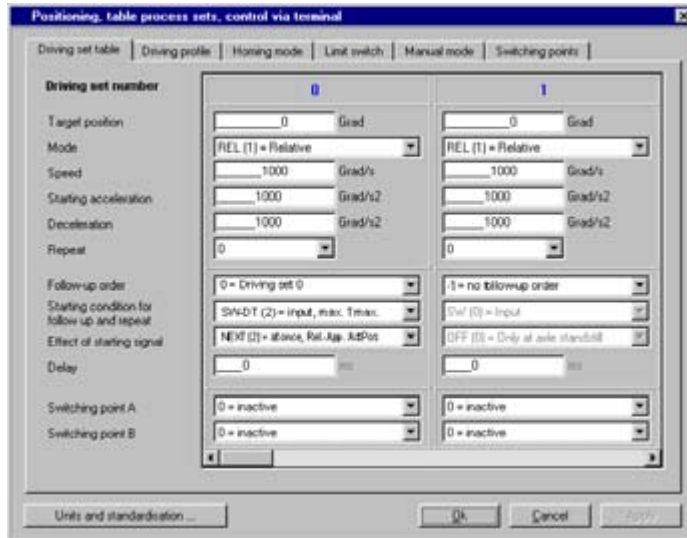

Fig. 5.15 Sequence of travel set selection with follow-up order logic

5.3.3 Parameterization of the travel set table



Target position

The target position can be parameterized in a user defined path unit.

DRIVEMANAGER	Value range	WE	Unit	Parameters
Target position	-2147483648 ... 2147483647	0	variable	272.x-PTPOS (_RTAB) x = travel set 0-15

Mode

The mode defines the relation to the target position. In this context please observe the notes in chapter 5.2.1-"Positioning modes".

DRIVEMANAGER	Value range	WE	Unit	Parameters
Mode	ABS ... SPEED	REL		274.x_PTMOD (_RTAB) x = travel set 0-15

Mode settings:

BUS	Setting	Effect
0	ABS	The target position always refers to a fixed reference zero point.
1	REL	A relative travel task always refers to a variable position. Depending on the start conditions for repeat or follow-up order this may either be the last target position or the current position.
2	SPEED	The axis moves with the speed profile programmed in the selected travel set. The target position is of no relevance.

Speed

The speed can be specified signed. A negative setting is only evaluated in case of an endless positioning. The speed is limited by the maximum speed in the travel profile.

DRIVEMANAGER	Value range	WE	Unit	Parameters
Speed	-2147483648 ... 2147483647	1000	variable	273.x_PTSPD (_RTAB) x = travel set 0-15

Acceleration

The acceleration values for starting and braking can be parameterized irrespective of each other. The input 0 means that the acceleration will take place with maximum ramp steepness or maximum torque. The acceleration values are limited by the maximum values in the travel profile.

DRIVEMANAGER	Value range	WE	Unit	Parameters
Start-up acceleration	0 ... 4294967295	10000	variable	276.x_PTACC (_RTAB) x = travel set 0-15
Braking acceleration	0 ... 4294967295	10000	variable	277.x_PTDEC (_RTAB) x = travel set 0-15

Repetition

A travel set with relative positioning can be repeated several times with the programmed value. Like the follow-up order, the repetitions of the travel set are started in dependence on the start condition. The execution of possible repetitions has priority over the execution of a follow-up order.

DRIVEMANAGER	Value range	WE	Unit	Parameters
Repetition	0 ... 255	0		762.x_FOREP (_RTAB) x = travel set 0-15

Follow-up order

The parameterization of a follow-up order for a travel set enables the realization of small automated sequential programs.

The setting "-1" signalizes that no further travel set (follow-up order) is to be activated.

DRIVEMANAGER	Value range	WE	Unit	Parameters
Follow-up order	-1 ... 15	-1		761.x_FONR (_RTAB) x = travel set 0-15

Start condition - activating condition "WANN"

This start condition can be used to adjust when a travel set is to be repeated or the follow-up order is to be activated.

DRIVEMANAGER	Value range	WE	Unit	Parameters
Start condition	SW ... WSTP	SW		764.x_FOST (_RTAB) x = travel set 0-15

Description of setting:

BUS	Setting	Meaning
0	SW	Switch- digital input or control bit starts the sequence

BUS	Setting	Meaning
1	DT	The repetition or the follow-up order is started with a programmable delay time after the target position has been reached.
2	SW-DT	A repetition or the follow-up order is started via a digital input or control bit, but at the latest after a defined delay time.
3	WSTP	The drive moves to the target position with speed v1 of the current travel set and then accelerates "on the fly" (without stop) to V2 or the repetition or the follow-up order.

Effect start condition - activation condition "WIE"

The "WIE"-condition is parameterized in dependence on the setting of the previously selected "WANN"-activation condition:

DRIVEMANAGER	Value range	WE	Unit	Parameters
Effect of start signal	OFF ... NEXT	OFF		765.x_FOSWC (_RTAB) x = travel set 0-15

Start condition = SW:

Activation of the follow-up order or repetition is flank triggered (High-Level). The effect of a start signal during a running positioning process can be parameterized, see Table 5.13.

Bus	Setting	Meaning
0	OFF	Signals occurring during an ongoing positioning process are ignored. Thus a signal never interrupts a running travel task.
1	STORE	Signals occurring during an ongoing positioning process cause an immediate change of the current target position. A relative proportion is added to the previous target position and approached without intermediate stop. The number of follow-up orders to be executed depends on the accumulated signal flanks. This function is useful for relative positioning.
2	NEXT	Signals occurring during an ongoing positioning process cause an immediate change of the current target position. A relative proportion is added to the actual position at the time of the change and approached without intermediate stop. This position is most suitable for compensation of a residual path.

Table 5.13 Effect of start condition for repetition and follow-up order

If no travel set is being processed or no repetition active, the signal to activate the follow-up order will start the travel set, that has been selected via terminal or field bus system. See "Travel set selection", page 5-28.

Start condition = SW-DT:

The parameters effect start signal (FOSWC) in Table 5.13 and the delay time (FODT) must be set.

Delay time

This field will only become active if the delay time (DT, SW-DT) for the follow-up order has been selected under start condition.

DRIVEMANAGER	Value range	WE	Unit	Parameters
Delay time	0 ... 65535	0	ms	763.x_FODT (_RTAB) x = travel set 0-15

Example travel set linkage with follow-up order logic

The following picture shows two examples for positioning with follow-up order (travel set 2).

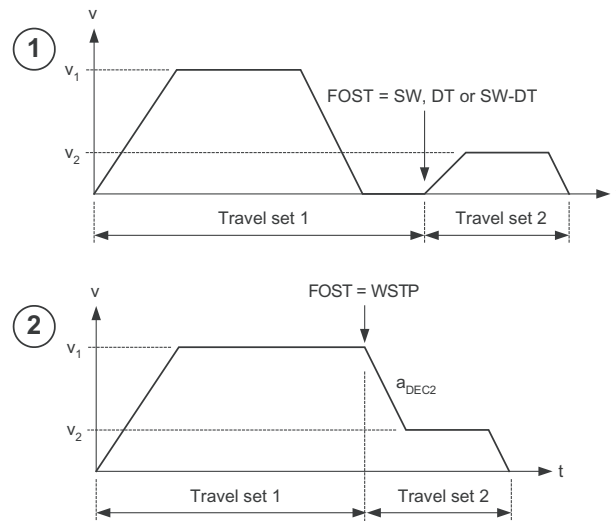

Switching point A and B

Two switching points can be evaluated per travel set. Switching points 0-3 are selected via two parameters. The entry 0 does not select a switching point (inactive).

DRIVEMANAGER	Value range	WE	Unit	Parameters
Switching point A	0 ... 4	0		771.x_PTSP1 (_RTAB) x = travel set 0-15
Switching point B	0 ... 4	0		772.x_PTSP2 (_RTAB) x = travel set 0-15

5.3.4 Switching points

Four switching points can be defined. Each switching point can modify up to three markers. The switching points can be used in all travel sets. A maximum of two switching points can be used in each travel set. Configuration takes place via the travel set dependent switching point configuration. Each switching point has the following settings.



Target position

The target position is effective in dependence on the switching point mode and its linkage with a travel set.

DRIVEMANAGER	Value range	WE	Unit	Parameters
Target position	-2147483648 ... 2147483647	0	variable	766.x_CPOS (_RTAB) x = switching point 0-3

Mode

DRIVEMANAGER	Value range	WE	Unit	Parameters
Mode	ABS ... RELE	ABS		767.x_CREF (_RTAB) x = switching point 0-3

Setting of mode:

BUS	Setting	Meaning
0	ABS	The switching point refers to the reference position or the absolute position of the system.
1	RELS	Relative to the travel set start position: Switching point responds after a relative path related to the start position.
2	RELE	Relative to the travel set end position: The switching point responds after a relative path before reaching the end position.

Marker

DRIVEMANAGER	Value range	WE	Unit	Parameters
Marker 1	OFF ... INV	OFF		768.x_CM1CF (_RTAB) x = switching point 0-3
Marker 2	OFF ... INV	OFF		769.x_CM2CF (_RTAB) x = switching point 0-3
Marker 3	OFF ... INV	OFF		770.x_CM3CF (_RTAB) x = switching point 0-3

Marker function:

BUS	Setting	Meaning
0	OFF	inactive
1	SET	Marker is set to 1
2	CLEAR	Marker is set to 0
3	INV	Marker is inverted

5.3.5 Teach in

DRIVEMANAGER:

The actual position is transferred to the corresponding table by means of the DRIVEMANAGER.

1. Opening of the manual mode window and selection of the tab "Travel set table".
2. Moving the drive to the position to be learned.
3. Enter the travel set number in the manual mode window and click on button "Accept".

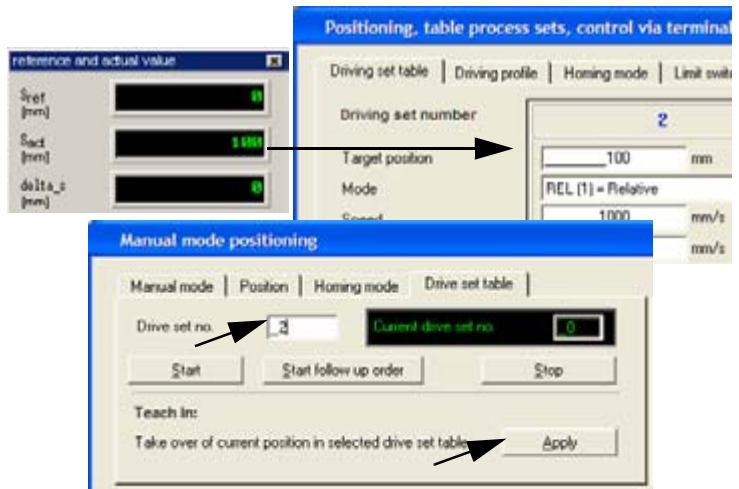

Fig. 5.16 Teach-In via DRIVEMANAGER

Terminals:

If an input is parameterized for "Teach in" (Fixx = TBTEA), the current position is transferred to the travel set in the table as target position, with ascending flank.

5.4 Positioning and control via field bus

With the preset solutions PCC_1 and PCB_1 the field bus is the reference source. The specific settings of the I/O-terminals is described in chapter 5.6.

Positioning via field bus either takes place via the device internal CAN_{open} field bus interface, or via the PROFIBUS communication module. All general positioning functions, as described under 5.2, can be used.

5.4.1 CAN_{open}

The drive controller is integrated into the automation network via the device internal electrically isolated CAN_{open} interface X5.

Communication takes place in accordance with profile DS301. Furthermore, a standardized communication with the device profile for drives with changeable speed DSP402 is assured. The following profiles are supported:

- **Homing Mode** (referencing) with 41 different types
- **Profile-Position-Mode** for direct travel set specification with device internal jerk-limited profile generation
- **Profile-Velocity-Mode** for speed regulation of the drive. This is a special positioning mode, solely used for endless travelling. A target position is of no relevance.

Online switching between modes, i.e. with active control, is possible. In addition, standardizations and units are applied according to the **Factor-Group** and the control according to the DRIVECOM-status machine.

Detailed information on configuration of the drive controller in the network can be found in the separate documentation "CAN_{open} data transfer protocol".

5.4.2 PROFIBUS

The travel set specification and control via PROFIBUS requires the external communication module CM-DPV1.

Control and target position specification is in accordance with the EasyDrive profile "DirectPos".

Detailed information on configuration of the drive controller in the network can be found in the separate documentation "PROFIBUS data transfer protocol".

5.5 Positioning with PLC

For the preset solutions PCP_1, PCT_3, PCC_3 and PCB_3 the PLC is preset as source of reference values. The specific settings on inputs and outputs for the control locations PLC (PCP_1), terminal (PCT_3), CAN_{open} (PCC_3) or PROFIBUS (PCB_3) are described in chapter 5.6.

With these presettings the various positioning commands GO [x] and STOP [x]. can be used. If the control location has also been set to PLC (PCP_1), the command SET ENCTRL = 0/1 can be used to switch the control off or on.

All general positioning functions, as described under 5.2, can be used. The travel set table can be called up via a special positioning commands GO T [x]. Automatic linkage via repetitions and follow-up orders as well as the switching points cannot be used when specifying reference values via PLC.

If the drive is controlled via field bus, the special proprietary EasyDrive protocol "ProgPos" is used.

Detailed information on handling the PLC as well as programming and operation with the PLC editor see see chapter 7 "User programming".

5.6 Assignment of control terminal

The control terminal for positioning is configured in dependence on the chosen preset solution.

5.6.1 Terminal assignment CDE3000

Depending on the selected presetting the parameterization of inputs and outputs differs from the factory setting, see Table 5.14. After selecting the presetting the parameterization of the terminals can be adapted to the application as desired.

I/O	Parameters	Function	Pre-set solution						
			SCT_1 (WE)	PCC_1 PCB_1	PCP_1	PCT_2	PCC_2 PCB_2	PCT_3	PCC_3 PCB_3
ISA0	180-FISA0	Function selector analog standard input ISA0+	PM10V	OFF	PLC	OFF	OFF	PLC	PLC
ISA1	181-FISA1	Function selector analog standard input ISA1+	OFF		PLC	OFF	OFF	PLC	PLC
ISD00	210-FIS00	Function selector digital standard input ISD00	START	OFF	PLC	START	OFF	RECAM	PLC
ISD01	211-FIS01	Function selector digital standard input ISD01	OFF	RECAM	RECAM	TBEN	RECAM	PLC	RECAM
ISD02	212-FIS02	Function selector digital standard input ISD02	OFF		PLC	TAB0		PLC	PLC
ISD03	213-FIS03	Function selector digital standard input ISD03	OFF		PLC	TAB1		PLC	PLC
ISD04		Function selector digital standard input ISD04	OFF		PLC	TAB2		PLC	PLC
ISD05		Function selector digital standard input ISD05	OFF		PLC	TAB3		PLC	PLC
ISD06		Function selector digital standard input ISD06	OFF		PLC			PLC	PLC
OSD00	240-FOS00	Function selector digital standard input OSD00	REF						
OSD01	241-FOS01	Function selector digital standard input OSD01	ROT_0						
OSD02	242-FOS02	Function selector digital standard input OSD02	S_RDY						
OSD03		Function selector digital standard input OSD03	OFF						

Table 5.14 Presetting of the control inputs and outputs on CDE3000

5.6.2 Terminal assignment CDB3000

Depending on the selected presetting the parameterization of inputs and outputs differs from the factory setting, see Table 5.15. After selecting the presetting the parameterization of the terminals can be adapted to the application as desired.

I/O	Parameters	Function	Pre-set solution						
			SCT_1 (WE)	PCC_1 PCB_1	PCP_1	PCT_2	PCC_2 PCB_2	PCT_3	PCC_3 PCB_3
ISA00	180-FISA0	Function selector analog standard input ISA00	PM10V	OFF	PLC	OFF	OFF	PLC	PLC
ISA01	181-FISA1	Function selector analog standard input ISA01	OFF		PLC			PLC	PLC
ISD00	210-FIS00	Function selector digital standard input ISD00	START	OFF	PLC		OFF		PLC
ISD01	211-FIS01	Function selector digital standard input ISD01	OFF		PLC	FOSW		PLC	PLC
ISD02	212-FIS02	Function selector digital standard input ISD02	OFF		PLC	TAB0		PCL	PCL
ISD03	213-FIS03	Function selector digital standard input ISD03	OFF	HOMSW	HOMSW	HOMSW	HOMSW	HOMSW	HOMSW
OSA00	200-FOSA0	Function selector for analog output OSA00	ACTN		PLC			PLC	PLC
OSD00	240-FOS00	Function selector digital standard input OSD00	REF						
OSD01	241-FOS01	Function selector digital standard input OSD01	ROT_0						
OSD02	242-FOS02	Function selector digital standard input OSD02	S_RDY						

Table 5.15 Presetting of the control inputs and outputs on CDB3000

5.6.3 Terminal assignment CDF3000

Depending on the selected presetting the parameterization of inputs and outputs differs from the factory setting, see Table 5.16. After selecting the presetting the parameterization of the terminals can be adapted to the application as desired.

I/O	Parameters	Function	Pre-set solution						
			SCT_1 (WE)	PCC_1 PCB_1	PCP_1	PCT_2	PCC_2 PCB_2	PCT_3	PCC_3 PCB_3
ISA0	180-FISA0	Function selector analog standard input ISA0+	PM10V	OFF	PLC	OFF	OFF	PLC	PLC
ISA1	181-FISA1	Function selector analog standard input ISA1+	OFF		PLC	OFF	OFF	PLC	PLC
ISD00	210-FIS00	Function selector digital standard input ISD00	START	OFF	PLC	START	OFF	RECAM	PLC
ISD01	211-FIS01	Function selector digital standard input ISD01	OFF	RECAM	RECAM	TBEN	RECAM	PLC	RECAM
ISD02	212-FIS02	Function selector digital standard input ISD02	OFF		PLC	TAB0		PLC	PLC
OSD00	240-FOS00	Function selector digital standard input OSD00	REF						
OSD01	241-FOS01	Function selector digital standard input OSD01	ROT_0						
OSD02	242-FOS02	Function selector digital standard input OSD02	S_RDY						

Table 5.16 Presetting of the control inputs and outputs on CDF3000

6 General software functions

6.1	Inputs and outputs	6-3
6.1.1	Digital inputs	6-4
6.1.2	Digital outputs	6-13
6.1.3	Analog inputs	6-24
6.1.4	Analog output for CDB3000	6-30
6.2	Setpoint generation	6-33
6.2.1	Rotary speed profile	6-34
6.2.2	Limitations	6-35
6.2.3	Stop ramps	6-37
6.2.4	Reference encoder/Master-Slave operation	6-40
6.2.5	Setpoint structure - further settings/control location	6-47
6.2.6	Control location	6-55
6.2.7	Motor potentiometer function	6-58
6.3	Motor control	6-62
6.4	Motor and transducer	6-67
6.4.1	Motor data	6-67
6.4.2	Encoder	6-74
6.4.3	Motor protection	6-83
6.4.4	Motor holding brake	6-90
6.5	Bus systems	6-100
6.5.1	CANopen	6-100
6.5.2	PROFIBUS	6-104
6.6	Cam controller	6-106
6.7	Setting KP200-XL	6-112

6.8	Actual values	6-117
6.8.1	Temperature monitoring	6-117
6.8.2	Device data	6-118
6.8.3	Options	6-119
6.8.4	CANopen Field bus	6-122
6.9	Warnings/errors	6-124
6.9.1	Error messages	6-124
6.9.2	Warningmessages	6-131

6.1 Inputs and outputs

Each input and output on the positioning controller has a parameter to assign a function. These parameters are called function selectors.

In addition, both the setpoint structure and the control location have an effect on the function of inputs and outputs. In the preset solutions such settings have already been made.

The positioning controllers are equipped with the inputs and outputs listed in Table 6.1.

Inputs/outputs	CDE3000	CDB3000	CDF3000
Analogue inputs	ISA0, ISA1	ISA0, ISA1	ISA0, ISA1
Digital inputs	ISD00 to ISD06	ISD00 to ISD03	ISD00 to ISD02
Virtual inputs	FIFO, FIF1	FIFO, FIF1	FIFO, FIF1
Input "Safe stop"	ISDSH		ISDSH
Analog outputs	-	OSA0	-
Digital outputs	OSD00 to OSD02	OSD00, OSD01	OSD00
Relay outputs	-RSH (only for safe stop) -OSD04	-OSD02	-RSH (only for safe stop) -OSD05
Power outputs 24V/2A (e.g. for motor holding brake)	OSD03	-	OSD03, OSD04
Virtual outputs	OV00, OV01	OV00, OV01	OV00, OV01

Table 6.1 Inputs and outputs of positioning controllers



For information on hardware for inputs and outputs see chapter 2.1 to chapter 2.3. The detailed specification is described in the corresponding operating instructions.

6.1.1 Digital inputs

Function	Effect
<ul style="list-style-type: none"> The function selector is used to determine the function of the digital inputs.. 	<ul style="list-style-type: none"> Free function assignment for all digital inputs

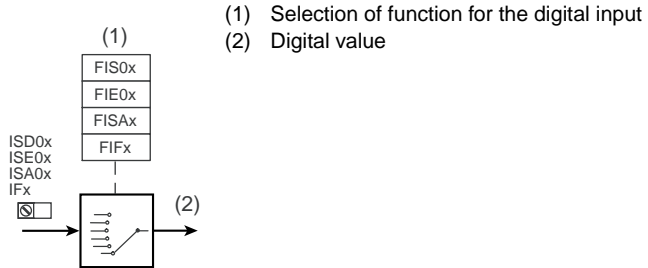
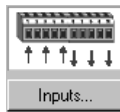

Fig. 6.1 Function block for adaptation of the digital inputs

1.



2.

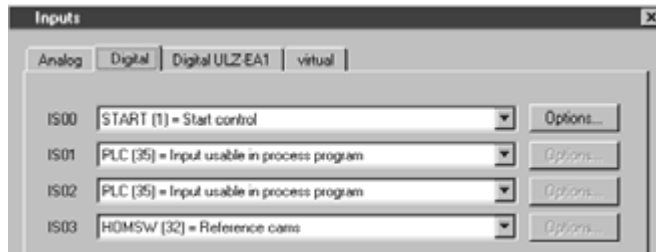

Fig. 6.2 Tab example "Digital inputs"

Parameter for setting the digital inputs

DRIVE-MANAGER	Function	Value range	WE	Parameter s	valid for positioning controller
ISD00	Function selector digital standard input ISD00	see Table 6.5	1-START	210-FIS00 (_IN)	CDE, CDB, CDF
ISD01	Function selector digital standard input ISD01	-“-	0-OFF	211-FIS01 (_IN)	CDE, CDB, CDF
ISD02	Function selector digital standard input ISD02	-“-	0-OFF	212-FIS02 (_IN)	CDE, CDB, CDF
ISD03	Function selector digital standard input ISD03	-“-	0-OFF	213-FIS03 (_IN)	CDE, CDB
ISD04	Function selector digital standard input ISD04	-“-	0-OFF	224-FIS04 (_IN)	CDE
ISD05	Function selector digital standard input ISD05	-“-	0-OFF	225-FIS05 (_IN)	CDE
ISD06	Function selector digital standard input ISD06	-“-	0-OFF	226-FIS06 (_IN)	CDE

Table 6.2 Parameter for setting the digital inputs

Parameter for setting the digital inputs on terminal extension module UM-8140

DRIVE-MANAGER	Function	Value range	WE	Parameter s	valid for positioning controller
IED00	Function selector for digital input of the user module IED00	see Table 6.5	0-OFF	214-FIE00 (_IN)	CDE, CDB, CDF
IED01	Function selector for digital input of the user module IED01	-“-	0-OFF	215-FIE01 (_IN)	CDE, CDB, CDF
IED02	Function selector for digital input of the user module IED02	-“-	0-OFF	216-FIE02 (_IN)	CDE, CDB, CDF
IED03	Function selector for digital input of the user module IED03	-“-	0-OFF	217-FIE03 (_IN)	CDE, CDB, CDF
IED04	Function selector for digital input of the user module IED04	-“-	0-OFF	218-FIE04 (_IN)	CDE, CDB, CDF

Table 6.3 Parameter for setting the digital inputs on terminal extension module UM-8140

DRIVE-MANAGER	Function	Value range	WE	Parameters	valid for positioning controller
IED05	Function selector for digital input of the user module IED05	-“-	0-OFF	219-FIE05 (_IN)	CDE, CDB, CDF
IED06	Function selector for digital input of the user module IED06	-“-	0-OFF	220-FIE06 (_IN)	CDE, CDB, CDF
IED07	Function selector for digital input of the user module IED07	-“-	0-OFF	221-FIE07 (_IN)	CDE, CDB, CDF

Table 6.3 Parameter for setting the digital inputs on terminal extension module UM-8140

Parameter for setting the virtual digital inputs

Virtual inputs have the fixed value 1 (High-Level). These can be used instead of a permanently switched on switch.

DRIVE-MANAGER	Function	Value range	WE	Parameters	valid for positioning controller
FIF0	Function selector for virtual digital fixed input 0	-“-	0-OFF	222-FIF0 (_IN)	CDE, CDB, CDF
FIF1	Function selector for virtual digital fixed input 1	-“-	0-OFF	223-FIF1 (_IN)	CDE, CDB, CDF

Table 6.4 Parameter for setting the virtual digital inputs



Options ...

Depending on the setting of the function selector an option is available for the corresponding input.

Setting the function selectors for the digital inputs:

BUS	Setting	Function	Effect
0	OFF	no function	Input switched off
1	START	Start closed-loop control	Start of closed-loop control - motor is energized. The sense of rotation depends on the setpoint. Low-High flank controlled Level controlled via AUTO-Start function under "Start "Level triggered" (Auto-Start)" on page 6-55. The reaction of the drive to remove the start signal can be programmed (see chapter 6.2.3, "Reactions in case of "Control off"").
2	STR	Start clockwise	Start release for clockwise rotation of motor (not during positioning). See also "Explanations to various functions".
3	STL	Start anti-clockwise	Start release for anti-clockwise rotation of motor (not during positioning). See also "Explanations to various functions".
4	INV	Reversal	The setpoint is inverted, this causes a reversal of the sense of rotation (only for speed control).
5	/STOP	/Quick stop	Quick stop in accordance with quick stop reaction (Low active) (see chapter 6.2.3, "Reactions with quick stop:").
6	SADD1	Changing the setpoint source 1 (280-RSSL1)	The setpoint source 1 (280-RSSL1) is switched over to the setpoint source set in 289-SADD1 (see chapter 6.2.5, "Setpoint structure - further settings/control location").
7	SADD2	Changing the setpoint source 2 (281-RSSL2)	The setpoint source 2 (281-RSSL2) is switched over to the setpoint source set in 290-SADD2 (see chapter 6.2.5, "Setpoint structure - further settings/control location").
8	E-EXT	External error	Error messages from external devices cause an error message with reaction, as specified in parameter 524-R-EXT (see chapter 6.9.1, "Error messages").
9	/E-EX	External error	Error messages from external devices cause an error message with reaction, as specified in parameter 524-R-EXT (see chapter 6.9.1, "Error messages") Low active.
10	RSERR	Resetting an error message	Error messages are reset with an ascending flank, if the error is no longer present (see 6.9.1, "Acknowledgement and resetting of errors")
11	TBTEA	Travel set positioning	Teach in for position travel set table (see chapter 5.3.5, "Teach in").
12	HOMST	Start referencing	Start referencing in accordance with the parameterized referencing type 730_HOMTD (see chapter 5.2.4, "Referencing").
13	TABO	Travel set selection (valence 2 ⁰)	Binary travel set selection (bit 0), (valence 2 ⁰) for speed (see chapter 4.5) or positioning (see chapter 5.3.1).

Table 6.5 Function selectors for digital inputs

BUS	Setting	Function	Effect
14	TAB1	Travel set selection (valence 2 ¹)	Binary travel set selection (bit 1), (valence 2 ¹) for speed (see chapter 4.5) or positioning (see chapter 5.3.1).
15	TAB2	Travel set selection (valence 2 ²)	Binary travel set selection (bit 2), (valence 2 ²) for speed (see chapter 4.5) or positioning (see chapter 5.3.1).
16	TAB3	Travel set selection (valence 2 ³)	Binary travel set selection (bit 3), (valence 2 ³) for speed (see chapter 4.5) or positioning (see chapter 5.3.1).
17	/LCW	Limit switch for clockwise rotation	Limit switch evaluation without overrun protection. The reactions for limit switch overrun and for mixed up limit switches can be adjusted (see chapter 6.9.1, "Error messages"). See also "Explanations to various functions".
18	/LCCW	Limit switch anti-clockwise rotation	Limit switch evaluation without overrun protection. The reactions for limit switch overrun and for mixed up limit switches can be adjusted (see chapter 6.9.1, "Error messages"). See also "Explanations to various functions".
19	SIO	Input appears in the status word of the serial interface (X4)	Status of input can be read out via the status word parameter 550-SSTAT of the serial interface.
20	OPTN	Evaluation via field bus module (PROFIBUS)	Evaluated through the PROFIBUS. (Placeholder, inputs can always be read via the field bus).
21	CAN	Evaluation via CAN-Bus	Evaluated via CAN-Bus (placeholder, inputs can always be read via field bus)
23	USER1	Only for CDB3000 up to software V2.0: reserved for special software	Only for CDB3000 up to software V2.0: Input can be used by special software.
24	USER2		
25	USER3		
23	DSEL	Select data set	Only with rotary speed control "OpenLoop" Changeover of data set (0=CDS1, 1=CDS2) (see chapter 8.2.1)
24	MP_UP	Motor potentiometer Raise setpoint	The rotary speed setpoint for the digital motor potentiometer function is raised (see chapter 6.2.7).
25	MP_DN	Motor potentiometer Reduce setpoint	The rotary speed setpoint for the digital motor potentiometer function is reduced (see chapter 6.2.7).
26	MAN	Activation of manual mode	With field bus operation (CAN, PROFIBUS) changeover of setpoint source (289-SADD1=xx) and control location to terminal (260-CLSEL=TERM). See also "Explanations to various functions".
27	TIPP	Jog mode, positive direction	In manual positioning the axis can be moved in creep speed or in rapid motion (see chapter 5.2.6).
28	TIPN	Jog mode, negative direction	In manual positioning the axis can be moved in creep speed or in rapid motion (see chapter 5.2.6).

Table 6.5 Function selectors for digital inputs

BUS	Setting	Function	Effect
29	TBEN	Release of table position	Acceptance of the selected positioning table index and execution of the corresponding travel set (see chapter 5.3.1).
30	/HALT	Feed enable	The running movement of the axis is interrupted according to the HALT reaction (see chapter 6.2.3, "Reaction with "Stop feed"") and continued when reset.
31	PLCIS	Stop PLC program	The PLC-program is stopped after the current command line has been processed. When removing the signal the program continues with the next command line.
32	HOMSW	Reference cams	for zero point determination in positioning
33	FOSW	Execution of follow-up order	in travel set positioning (see chapter 5.3.2)
34	CAMRS	Resetting the cycle of the cam switching unit	Setting the zero position of the cam switching unit (see chapter 6.6).
35	PLC	Input used in sequence program	Placeholder, inputs can always be read, irrespective of the setting.
36	PLCGO	Start/stop the sequence program	The PLC-program is started with the first command line. Cancelling ends the program run (see chapter 7.4).
For the CDB3000 a HTL-encoder can be additionally connected to the inputs ISD01 - ISD03. In this case the setting is:			
37	ENC	HTL - encoder	0-track ISD01 (index signal), A-track ISD02 and B-track ISD03 (see chapter 6.4.2, "Encoder for CDB3000").

Table 6.5 *Function selectors for digital inputs*

$F_{xxx} = STR, STL$
(Not with positioning)

Explanation of various functions

The start command for a direction of rotation can be specified via the terminals of the positioning controller. The sense of rotation is thus determined by the start commands STR and STL.

If the setpoint has a negative sign, this will cause an inverse behaviour when starting, i.e. with a clockwise start the motor shaft will turn anti-clockwise.

STL	STR	Explanation
0	0	STOP, braking and shut-down of control as per reaction with "Control off" (see chapter 6.2.3, "Stop ramps"). ¹⁾
1	0	START anti-clockwise, acceleration with travel profile generator
0	1	START clockwise, acceleration with travel profile generator
1	1	BRAKING and shut-down of control as per reaction with "Control off" (see chapter 6.2.3, "Stop ramps"). ¹⁾ The braking process can be interrupted by simply attaching a start contact; the motor will accelerate again.
$\begin{matrix} 0 \\ \downarrow \\ 1 \end{matrix}$	$\begin{matrix} 1 \\ \downarrow \\ 0 \end{matrix}$	Sense of rotation REVERSING, overlapping time (STL and STR = 1) min. 2 ms

1) With "OpenLoop" speed control the DC holding current controller (see chapter 8.3.4) becomes active in case of the response "Control off" = "1=Braking with deceleration ramp" when the speed setpoint "0" is reached.

Table 6.6 Truth table for control via terminals

$F_{xxx} = /LCW, /LCCW$

The limit switch evaluation is based on the evaluation of static signals. No signal flanks are evaluated.

The limit switches are monitored in dependence on the sense of rotation, so that mixed up limit switches will be reported as errors. The drive runs out unguided.

The reactions for limit switch overrun and for mixed up limit switches can be adjusted (see chapter 6.9.1, "Error messages").

Mechanical overtravelling of limit switches is not permitted and is not monitored for plausibility.

Example: If the right limit switch is approached during clockwise rotation, the signal will cause the drive to stop. However, if this signal is overtravelled and the limit switch is no longer dampened, the motor will start will restart in clockwise direction as long as clockwise starting is still enabled.

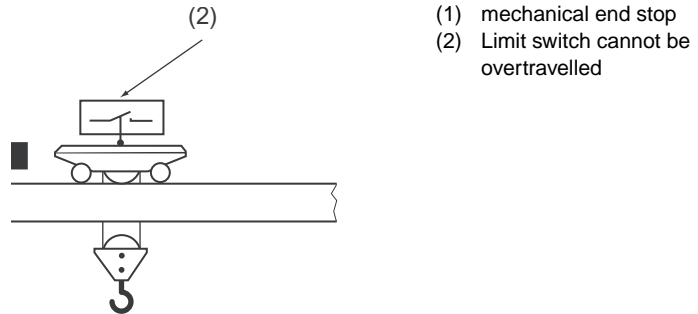

Fig. 6.3 Limit switch evaluation



Note: The evaluation of pulse switches or upstream limit switches is not supported. Bridging in limit switch, supply line and control cabinet is not monitored or detected.

Flxxx = MAN
(Only with positioning via field bus)

The "MAN" function has the effect that a device configured for bus operation can be directly operated on the positioning controller in-situ by the operator. This function can be used for set-up or emergency operation of the system.

The changeover is not possible with activated power stage or if the DRIVEMANAGER is operated in control mode/manual mode.

If the input is activated, the control location is set to "Terminal" (260-CLSEL=TERM). At the same time the setpoint source is set to the reference specified by parameter 289-SADD1. The selection of the setpoint source must be made in the function mask "Reference/Ramps - Further Settings" (see Fig. 6.4).

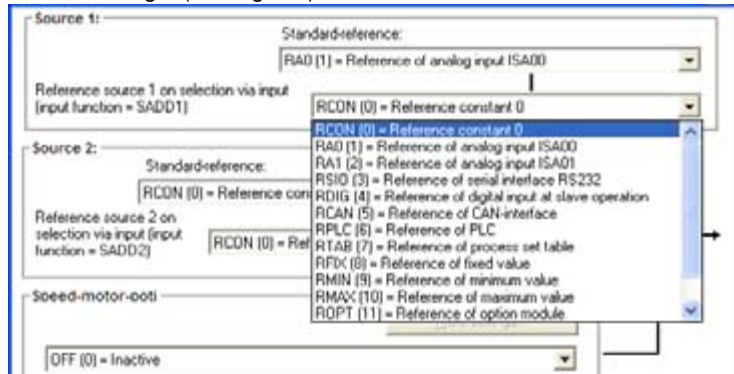

Fig. 6.4 Setting the parameter SADD1 in "MAN" mode

A start signal must be switched to a digital input and parameterized (Flxxx = START).



Note: While the "MAN" function is active no "Saving of device settings" must take place, because the device setting would be changed in the background and the original setting would not become active when switching on the mains supply the next time.

6.1.2 Digital outputs

Function	Effect
<ul style="list-style-type: none"> The function selectors are used to determine the function of the digital outputs. 	<ul style="list-style-type: none"> Free function assignment for all digital outputs

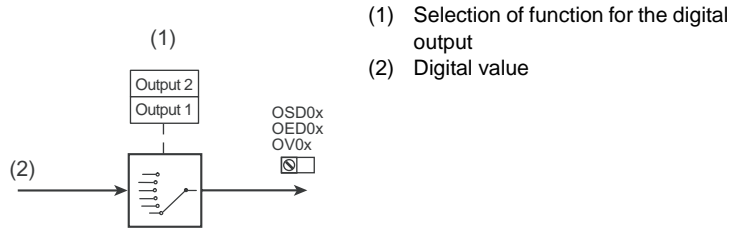
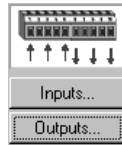

Fig. 6.5 Function block for adaptation of the digital inputs

1.



2.

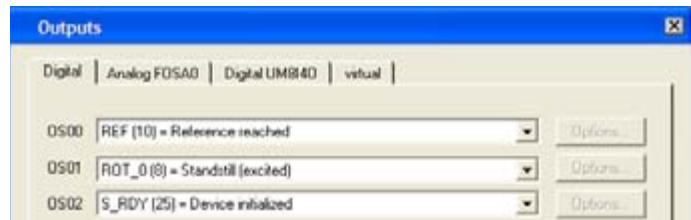

Fig. 6.6 Tab example "Digital outputs"

Parameter for setting the digital outputs

DRIVE-MANAGER	Function	Value range	WE	Parameters	valid for positioning controller
OSD00	Function selector digital standard input OSD00	see Table 6.10	10-REF	240-FOS00 (_OUT)	CDE, CDB, CDF
OSD01	Function selector digital standard input OSD01	-“-	8-ROT_0	241-FOS01 (_OUT)	CDE, CDB
OSD02	Function selector for standard output OSD02 <ul style="list-style-type: none"> Digital output with CDE, CDF Two-way relay with CDB 	-“-	25-S-RDY	242-FOS02 (_OUT)	CDE, CDB
OSD03	Function selector for electronic power drivers (2 A) OSD03	-“-	0-OFF	251-FOS03 (_OUT)	CDE, CDF
OSD04	Function selector digital standard input OSD04 <ul style="list-style-type: none"> Normally open relay with CDE electronic power driver (2 A) with CDF 	-“-	0-OFF	250-FOS04 (_OUT)	CDE, CDF
OSD05	Function selector, relay output (normally open) CDF	-“-	0-OFF	252-FOS05 (_OUT)	CDF
OED00	Function selector for digital output of the user module OED00	-“-	0-OFF	243-FOE00 (_OUT)	CDE, CDB
OED01	Function selector for digital output of the user module OED01	-“-	0-OFF	244-FOE01 (_OUT)	CDE, CDB
OED02	Function selector for digital output of the user module OED02	-“-	0-OFF	245-FOE02 (_OUT)	CDE, CDB
OED03	Function selector for digital output of the user module OED03	-“-	0-OFF	246-FOE03 (_OUT)	CDE, CDB

Table 6.7 Parameter for setting the digital outputs

Parameter for setting the digital outputs on terminal extension module UM-8140

DRIVE-MANAGER	Function	Value range	WE	Parameters	valid for positioning controller
OED00	Function selector for digital output of the user module OED00	-“-	0-OFF	243-FOE00 (_OUT)	CDE, CDB

Table 6.8 Parameter for setting the digital outputs on terminal extension module UM-8140

OED01	Function selector for digital output of the user module OED01	-"-	0-OFF	244-FOE01 (_OUT)	CDE, CDB
OED02	Function selector for digital output of the user module OED02	-"-	0-OFF	245-FOE02 (_OUT)	CDE, CDB
OED03	Function selector for digital output of the user module OED03	-"-	0-OFF	246-FOE03 (_OUT)	CDE, CDB

Table 6.8 Parameter for setting the digital outputs on terminal extension module UM-8140

Parameter for setting the virtual digital outputs

Virtual outputs can be used, among others, for:

- Creation of an event for the TxPDO event control in CANopen field bus communication
- Status evaluation in the PLC

DRIVE-MANAGER	Function	Value range	WE	Parameters	valid for positioning controller
OV00	Function selector for virtual digital output OV00c	-"-	0-OFF	248-FOV00 (_OUT)	CDE, CDB, CDF
OV01	Function selector for virtual digital output OV01	-"-	0-OFF	249-FOV01 (_OUT)	CDE, CDB, CDF

Table 6.9 Parameter for setting the virtual digital outputs

Settings for the function selectors

BUS	Setting	Function	Effect
0	OFF	no function	Output switched off.
1	ERR	Collective error message	Device is in error state. The error must be rectified and reset before resuming operation (see chapter 6.9.1, "Error messages").
2	WARN	Collective warning message	Parameterizable warning limit fallen short of, device still operable (see chapter 6.9.2, "Warning messages").
3	/ERR	Collective message fault denied	Device is in error state. The error must be rectified and reset before resuming operation (see chapter 6.9.1, "Error messages").

Table 6.10 Setting the function selectors FOxxx for the digital outputs

BUS	Setting	Function	Effect
4	/WARN	Collective message warning denied	Parameterizable warning limit exceeded, device still operable. Fail-safe design (see chapter 6.9.2, "Warning messages").
5	ACTIVE	Control in function	Power stage active and closed-loop control/control functioning
6	ROT_R	Sense of rotation clockwise	Motor turns clockwise.
7	ROT_L	Sense of rotation anti-clockwise	Motor turns anti-clockwise.
8	ROT_0	Motor stopped	Motor in standstill window, depending on actual value.
9	LIMIT	Setpoint limitation active	The internally processed setpoint exceeds the reference value limitation and is maintained at limit value level (see "Explanation of various functions") .
10	REF	Setpoint reached	The specified setpoint has been reached, depending on actual value (see "Explanation of various functions").
11	SIO	Access to control word of RS232	The output can be set by means of the LUSTBus-control word via the serial interface.
12	OPTN	Reserved for the communication module (PROFIBUS)	The output is set via the module CM_DPV1 (PROFIBUS).
13	CAN	Reserved for CAN-Bus	The output is set via the CAN-Bus.
14	BRK1	Holding brake function 1	Output becomes active in accordance with the holding brake function, see chapter 6.4.4. Only suitable for U/f-operation!
15	BRK2	Holding brake function 2	Output becomes active in accordance with the holding brake function, see chapter 6.4.4.
16	WUV	Warning undervoltage in d.c. link	Warning message, if the voltage in the d.c. link falls short of the value specified in parameter 503-WLUV. Device operable (see chapter 6.9.2, "Warning messages").

Table 6.10 *Setting the function selectors FO_{xx} for the digital outputs*

BUS	Setting	Function	Effect
17	WOV	Warning overvoltage in d.c. link	Warning message, if the voltage in the d.c. link exceeds the value specified in parameter 5043-WLOV. Device still operable (see chapter 6.9.2, "Warning messages").
18	WIIT	Warning, I ² t-integrator has started (device)	Warning message, if the integrator for current I ² over time t has started as device protection (see chapter 6.9.2, "Warning messages").
19	WOTM	Warning motor temperature	Warning message, if the motor temperature has exceeded the value specified in parameter 502-WLTM (see chapter 6.9.2, "Warning messages").
20	WOTI	Warning, heat sink temperature of device	Warning message, if the heat sink temperature of the device exceeds the value specified in parameter 500-WLTI.
21	WOTD	Warning, internal temperature in device	Warning message, if the internal temperature in the device has exceeded the value specified in parameter 501-WLTD (see chapter 6.9.2, "Warning messages").
22	WLIS	Warning message apparent current limit value	Warning message, if the apparent current has exceeded the value specified in parameter 506-WLIS (see chapter 6.9.2, "Warning messages").
23	WLS	Warning message speed limit	Warning message, if the rotary speed has exceeded the value specified in parameter 505-WLS (see chapter 6.9.2, "Warning messages").
24	WIT	Warning Ixt-integrator has started (motor)	Warning message, if the motor protection integrator has exceeded the programmable threshold 337-WLITM (see chapter 6.9.2, "Warning messages").
25	S_RDY	Device initialized	The output becomes active if the device has been initialized after the power supply has been switched on
26	C_RDY	Device operable	The output becomes active, if the device is "operable" by setting the signal ENPO and no error message is applied.

Table 6.10 Setting the function selectors FOxxx for the digital outputs

BUS	Setting	Function	Effect
27	USER0	Reserved for special software	Output can be used by special software.
28	USER1		
29	USER2		
30	USER3		
31	WLTQ	Warning message torque limit value exceeded	Warning message, if the torque exceeds the value specified in parameter 507-WLTQ.
32	ENMO	Switching of motor contactor	The output becomes active when starting the control and the up-time is extended by the time 247-TENMO when cancelling the start and stopping the drive (see "Explanation of various functions").
33	/ENMO	Switching of motor contactor, denied function	The output becomes inactive when starting the control and the down-time is extended by the time 247-TENMO when cancelling the start and stopping the drive (see "Explanation of various functions").
34	PLC	Output of sequential program can be used	Output is set by PLC-program, e. g. SET OS00 = 0/1, Mxxx (see chapter 7.3.2, "Setting commands (SET)").
35	REFOK	Referencing	Referencing successfully completed.
36	TAB0	Active table travel set	(Valence 2 ⁰)
37	TAB1	Active table travel set	(Valence 2 ¹)
38	TAB2	Active table travel set	(Valence 2 ²)
39	TAB3	Active table travel set	(Valence 2 ³)
40	TBACT	Travel set active	Table travel set positioning active
41	/EFLW	No trailing error	
42	STOP	Quick stop active	The drive is in "Quick stop" state.
43	CM1	Switching point 1	<ul style="list-style-type: none"> • Cam switching point (see chapter 6.6) • Switching point flag for positioning by means of table travel sets (see chapter 5.3.4)
44	CM2	Switching point 2	
45	CM3	Switching point 3	

Table 6.10 Setting the function selectors FOxxx for the digital outputs

BUS	Setting	Function	Effect
46	CM4	Switching point 4	Cam switching points (see chapter 6.6)
47	CM5	Switching point 5	
48	CM6	Switching point 6	
49	CM7	Switching point 7	
50	CM8	Switching point 8	
51	CM9	Switching point 9	
52	CM10	Switching point 10	
53	CM11	Switching point 11	
54	CM12	Switching point 12	
55	CM13	Switching point 13	
56	CM14	Switching point 14	
57	CM15	Switching point 15	
58	CM16	Switching point 16	
59	/BRK1	Holding brake function 1, inverted (without motor current monitoring)	Output becomes inactive in accordance with the holding brake function, see chapter 6.4.4. Only suitable for U/f-operation!
60	/BRK2	Holding brake function 2, inverted	Output becomes inactive in accordance with the holding brake function, see chapter 6.4.4.

Table 6.10 Setting the function selectors FOxxx for the digital outputs

$FO_{xxx} = LIMIT$

Explanation of various functions

The LIMIT function detects if the setpoint exceeds the maximum value. When exceeding, the output is set.

Limit values:

- Torque control:
The limit value display becomes active when the torque reference exceeds the max. torque.
Max. torque = 805-SCALE x 803-TCMMX x 852-MOMNM
- Speed regulation:
The limit value display becomes active when the speed reference exceeds the max. speed.
Max. speed = 813-SCSMX x 157-MOSNM
- Positioning:
The limit value display becomes active when the speed reference exceeds the max. speed or the torque reference exceeds the max. torque.
Max. torque = 805-SCALE x 803-TCMMX x 852-MOMNM
Max. speed = 813-SCSMX x 157-MOSNM

The specified parameters (except the online torque scaling 805-SCALE) can be set in the function mask "Limitations" (see chapter 6.2.2).

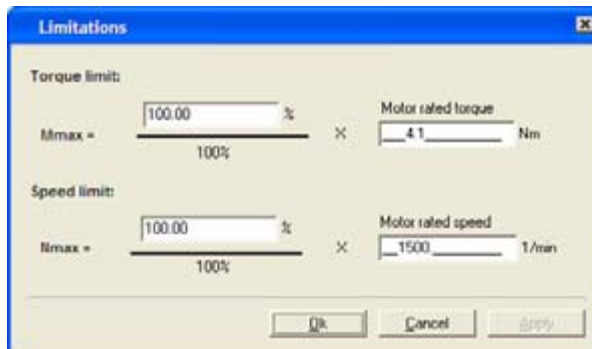

Fig. 6.7 Function mask "Limitations"

Explanations

- Both the special PLC-flag STA_LIMIT and the bit "LIMIT" in the field bus EasyDrive status words have the same meaning.

$FO_{xxx} = REF$

Both the parameters 230-REF_R (setting see chapter 4.2.1) for torque and speed regulations as well as 758-POWIN (setting see chapter 5.2.3) for positioning can be used to define an area, in which the actual value

may deviate from the setpoint, without the message "Setpoint reached" (REF) becoming inactive. Setpoint fluctuations caused by setpoint specification, e. g. via analog inputs can therefore be taken into account.

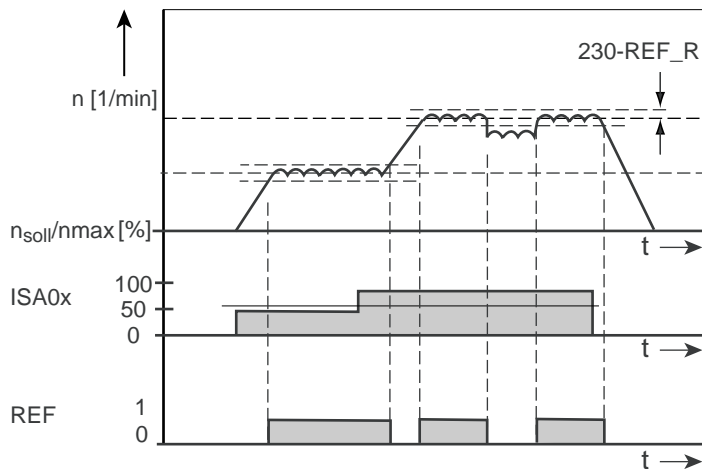

Fig. 6.8 Digital output with setting "Setpoint reached" with use of the window "Setpoint reached" in speed regulation

The message "Setpoint reached" depends on the type of control:

- Torque control: Setpoint torque reached
- Speed regulation: Setpoint speed reached
- Positioning:
 - Absolute/relative positioning: Setpoint position reached
If an ongoing positioning process is interrupted, e. g. with HALT, the message "Setpoint reached" will in this phase not be submitted. The message will only appear after the actual target position has been reached.
 - Endless positioning (speed mode): Setpoint speed reached

Explanations

- "Clockwise rotation" (ROT_R) or "Anti-clockwise rotation" (ROT_L) is detected in dependence on parameter 230-REF_R.

FOxxx = ENMO, /ENMO

Switching process in the motor lead must generally take place in de-energized state, as otherwise problems, such as burnt off contactor contacts, overvoltage or overcurrent breaks of the positioning controller will occur.

In order to assure de-energized switching the contacts of the motor contactor must be closed before the inverter power stage is released. In

the opposite case the contacts must remain closed until the inverter power stage has been switched off.

This can be achieved by implementing the corresponding safety periods for switching of the motor contactor into the control sequence of the machine or by using the special ENMO software function of the positioning controller.

The power contactor in the motor supply line can be controlled by the positioning controller. With the timer parameter 247-TENMO the pickup and drop off time of the power contactor can be accounted for. With this one can make sure that, after the start release, the setpoint is only specified after the contactor has closed, or, with inactive power stage, the motor is disconnected from the positioning controller by the contactor.



Note: In the time base of the TENMO timer additional times for typical contactor chattering have been taken into account. Depending on the contactor, these may take several 100 ms.

ENMO setting = motor contactor:

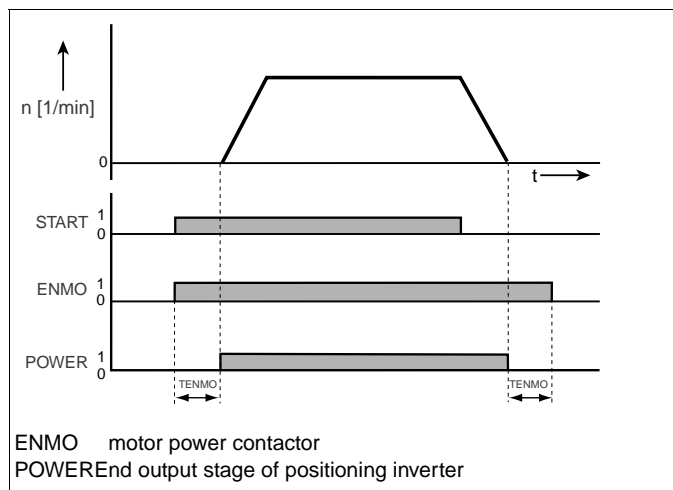

Fig. 6.9 Function of motor contactor control via digital output with ENMO setting

- With setting TENMO=0 the motor contactor function is deactivated.
- With activation of the ENMO function the motor contactor is automatically closed during the self-setting process
- The motor contactor function is active if one of the function selectors of digital outputs OSD0x or OED0x has the value ENMO or /ENMO. The time TENMO can be set in the DriveManager after selecting the function under "Options".

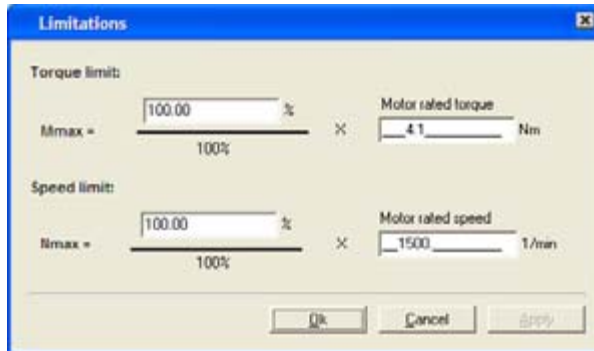

Fig. 6.10 Setting the breaking delay TENMO

DRIVEMANAGER	Value range	WE	Unit	Parameters
Making and breaking delay between digital output of motor contactor and controller release (output stage release)	0 ... 2000	300	ms	247-TENMO (_OUT)



Note: If switching takes place with the output stage in the motor line still active, a reactance coil must be used to avoid the error message E-OC caused by transient currents in the switching phase. Furthermore, with error message E-OC-1 the system will check whether the hardware release ENPO is applied before submitting the error message. If this is not the case, it is assumed that an intended switching process by a motor contactor took place in the motor line and error message will be suppressed.

6.1.3 Analog inputs

Function	Effect
<ul style="list-style-type: none"> Determination of the internal processing of analog input signals 	<ul style="list-style-type: none"> Processing and filtering of analog setpoint specification signals

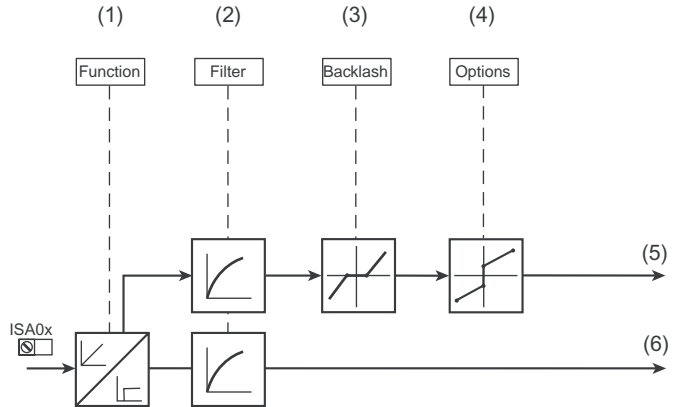

- (1) Specification of analog setpoint or use as digital input
- (2) Input filter for interference decoupling
- (3) Dead band function for interference decoupling around the zero point
- (4) Options for standardizing the analog input
- (5) Analog value
- (6) Digital value

x Number of input

Fig. 6.11 Function block for adaptation of the digital inputs

Configuration possibilities ISA0x

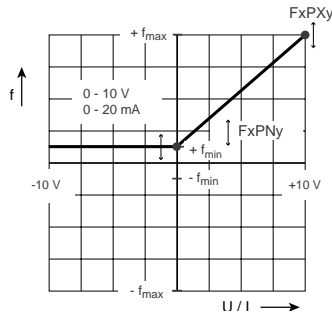

Fig. 6.12 Standardizing with unipolar operation

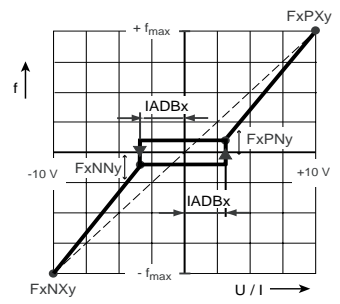

Fig. 6.13 Dead band function with bipolar operation

1.
2.

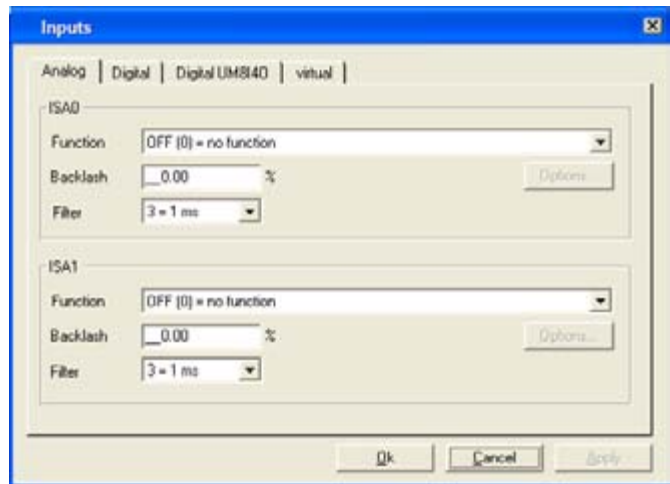
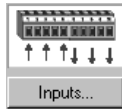

Fig. 6.14 Analog inputs

Both analog inputs ISA0 and ISA1 can also be configured as digital inputs. For this purpose the settings OFF (0) to PLCGO (36) of the function selectors FISA0 and FISA1 are available, as with the digital inputs, see also Table 6.5. In addition there are the settings 0-10V (38) to OVR (43) for use as analog inputs. Table 6.11 shows these additional adjustment possibilities of the function selectors.

Function selectors FISA0 and FISA1:

DRIVEMANAGER	Meaning	Value range	WE	Unit	Parameters
Function	Determination of the internal processing of analog input signals	OFF ... 4-20	PM10V OFF		180_FISA0 181_FISA1 (_IN)
Dead band	Dead band around zero	0.00 ... 999.95	0.00	%	192_IADB0 193_IADB1 (_IN)
Filter	Filter time of the analog input	0 ... 7	3	ms	188_AFIL0 189_AFIL1 (_IN)

Setting of filters AFIL0 and AFIL1:

DRIVEMANAGER	Meaning
0	0 ms
1	300 µs
2	500 µs
3	1 ms
4	2 ms
5	4 ms
6	8 ms
7	16 ms



Options ...

Various options are available, depending on the setting "Function". Fig. 6.15 shows the options mask for setting the function selector to "PM10 V(40) = analog setpoint input -10V...+10V".

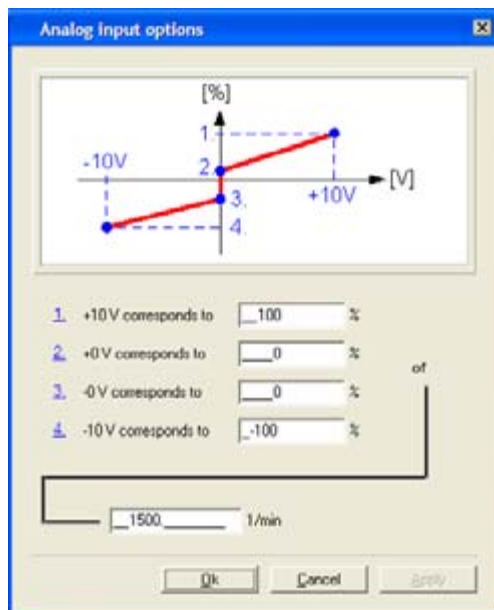

Fig. 6.15 Options analog input ISA0 with setting PM10V

Parameter for the analog input ISA0

DRIVEMANAGER	Meaning	Value range	WE	Unit	Parameters
1.	Maximum value ISA00 at +10V	-1000 ... 1000	100	%	182_FOPX (_IN)
2.	Minimum value ISA00 at +0V	-1000 ... 1000	0	%	183_FOPN (_IN)
3.	Minimum value ISA00 at -0V	-1000 ... 1000	0	%	185_FONN (_IN)
4.	Maximum value ISA00 at -10V	-1000 ... 1000	-100	%	184_FONX (_IN)
Rated motor speed	Setpoint of scaling with speed control (see chapter 6.2.2, "Limitations")	0 ... 100000	1500	rpm	157_MOSNM (_MOT)
Rated motor torque	Reference value for scaling with torque control (see chapter 6.2.2, "Limitations")	0.001 ... 5000	4.1	Nm	852_MOMNM (_MOT)

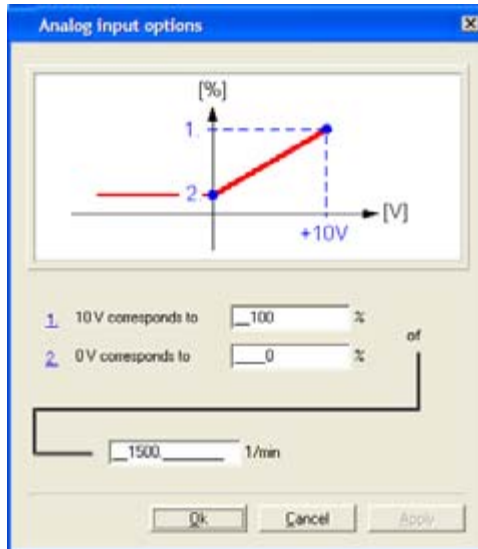

Fig. 6.16 Options analog input ISA1 for setting 0-10V

Parameter for the analog input ISA1

DRIVEMANAGER	Meaning	Value range	WE	Unit	Parameters
1.	Maximum value ISA01 at +10V	-1000 ... 1000	100	%	186_F1PX (_IN)
2.	Minimum value ISA01 at +0V	-1000 ... 1000	0	%	187_F1PN (_IN)
Rated motor speed	Reference value of scaling with speed control (see chapter 6.2.2, "Limitations")	0 ... 100000	1500	rpm	157_MOSNM (_MOT)
Rated motor torque	Reference value of scaling with torque control (see chapter 6.2.2, "Limitations")	0.001 ... 5000	4.1	Nm	852_MOMNM (_MOT)



Note: The resolution of the analog inputs is 10 bit. In order to achieve an optimal interference suppression they are scanned and filtered with 250 μ s. Further processing takes place with 1 ms.

Setting the function selectors FISA0 and FISA1:

Bus	Setting	Function	Effect	ISA0	ISA1
38	0-10V	Analog setpoint input 0-10 V	Setpoint specification 0-10 V. Observe the standardization and adapt the setpoint structure by means of the setpoint selector.		✓
39	SCALE	Torque scaling	Online torque scaling 0 - 100% of the maximum value (see chapter 6.2.2). The torque scaling is tapped directly after the analog filter and before the dead band. The dead band is thus without any effect for these functions!		✓
40	PM10V	Analog setpoint input -10 V ... +10 V	Setpoint specification 0-10 V. Observe the standardization and adapt the setpoint structure by means of the setpoint selector.	✓	
41	0-20V	Current input	Only for CDB3000! 0 ... 20 mA current input	✓	
42	4-20V	Current input 4 ... 20 mA	Only for CDB3000! If the current drops below 3 mA the open-circuit monitoring is triggered. The reaction to this error message is determined by parameter 529-R-WBK.	✓	
43	OVR	Speed override	0 - 150% Scaling of the parameterized travel speed in positioning (see chapter 5.2.3, sub-subject "Speed override"). The override is tapped directly after the analog filter and before the dead band. The dead band is thus without any effect for these functions!		✓

Table 6.11 Function selectors for analog inputs FISA0 and FISA1

6.1.4 Analog output for CDB3000

Function	Effect
<ul style="list-style-type: none"> Determination which scaled actual value is to be submitted to the analog output (0 ... 10V) 	<ul style="list-style-type: none"> Processing and filtering of analog actual values Free assignment of function to the analog output Output of analog values with a max. frequency of 100 Hz The analog output serves the purpose of diagnostics by means of a Voltmeter, if no DRIVEMANAGER with Digital-Scope is available

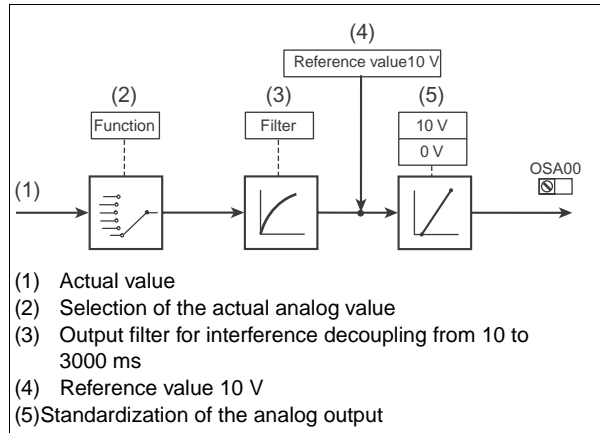
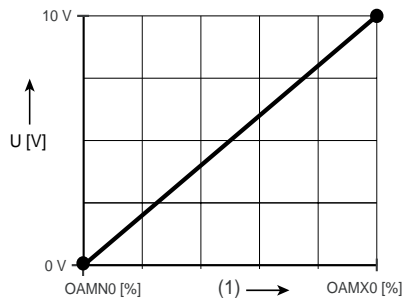

Fig. 6.17 Function block for adaptation of the analog output

Configuration possibilities OSA00



(1) Output value, e. g. frequency

Fig. 6.18 Standardization of the analog output

1.
2.

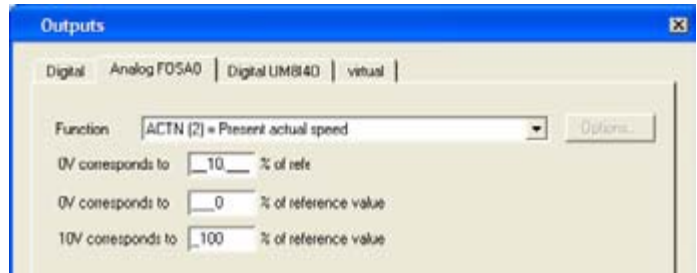
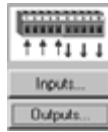

Fig. 6.19 Tab "Analog outputs FOSA0" of the CDB3000

DRIVEMANAGER	Value range	WE	Unit	Parameters
Function	OFF ... PLC	ACTN		200_FOSA0 (_OUT)
Filter	10 ... 3000	10	ms	203_OATF0 (_OUT)
0V corresponds with	-200 ... 200	0	%	201_OAMNO (_OUT)
10V corresponds with	-200 ... 200	100	%	202_OAMX0 (_OUT)

Explanations

- For both corner points (0 V, 10 V) the actual value can be adapted in the range from - 200 % to + 200 % from a reference value.
- In the hardware the analog output is filtered by a filter with a cut-off frequency of 100 Hz.

Setting the function selector for FOSA0:

BUS	Setting	Function	Reference value
0	OFF	no function, the input is switched off	
1	ACTT	current actual torque	max. torque
2	ACTN	current actual speed	max. speed
3	AACTN	Value of the current actual speed	max. speed
4	APCUR	actual apparent current	$2 * I_N$

BUS	Setting	Function	Reference value
5	ISA00	ISA00	10 V / 20 mA
6	ISA01	ISA01	10 V
7	MTEMP	actual motor temperature	200 °C
8	KTEMP	actual heat sink temperature	200 °C
9	DTEMP	actual inside temperature	200 °C
10	PLC	Specify the value from the sequencing control	10.000

6.2 Setpoint generation

Function	Effect
<ul style="list-style-type: none"> The setpoint generation serves the preparation of the setpoint. Here the application dependent setpoint structure is supplied with "raw data" and limited. The setpoint is changed in dependence on various system conditions (errors, warnings, etc.). 	<ul style="list-style-type: none"> All system conditions have an effect on the setpoint.

1.



2.

Fig. 6.20 shows all functions of the setpoint generation for closed-loop control types speed control and torque control. These functions are described next. If this mask is opened when presetting a positioning process, the "Speed profile" function will not be displayed.

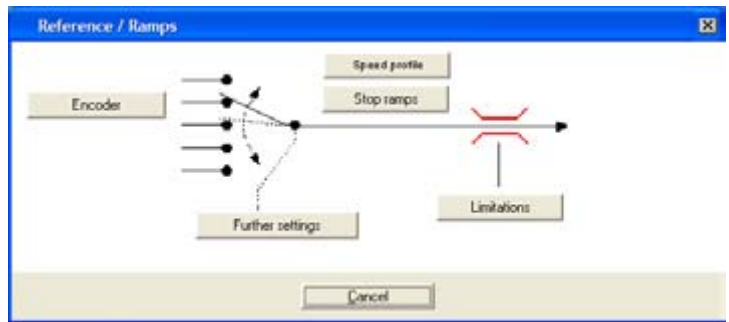

Fig. 6.20 Tab Setpoints / Ramps

6.2.1 Rotary speed profile

Function	Effect
<ul style="list-style-type: none">• Setting of acceleration and deceleration ramps for the rotary speed profile• Setting of a slip for the start and end points of the linear ramp	<ul style="list-style-type: none">• Matching the dynamics of the motor to the application• Jerk reduced moving of the drive

This function is only available for speed controlled and, to a limited extent, for torque controlled presettings. It is described in chapter 4.2.1.

6.2.2 Limitations

Function	Effect
<ul style="list-style-type: none"> Limitation of torque and speed 	<ul style="list-style-type: none"> Setting maximum and minimum values

The maximum permissible torque and the maximum speed are set as a percentage of their nominal values.



Note: If the setting is higher, the percentage based scaling of the torque is automatically reduced to the maximum torque that can be set with the drive controller, during the controller initialization.

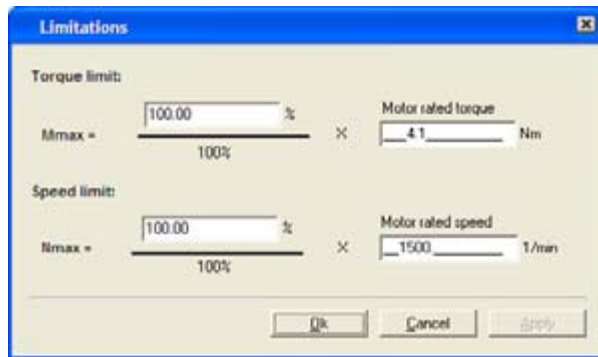

Fig. 6.21 Limitations

DRIVEMANAGER	Value range	WE	Unit	Parameters
Torque limitation	0.00 ... 999.95	100.00	%	803_TCMXX (_CTRL)
Rated motor torque	0.001 ... 5000	4.1	Nm	852_MOMNM (_MOT)
Speed limitation	0.00 ... 999.95	100.00	%	813_SCSMX (_CTRL)
Rated motor speed	0 ... 100000	1500	rpm	157_MOSNM (_MOT)

There are two possible ways to limit the torque variably, while the closed-loop control is active:

1. Torque limitation via analog input ISA1
 With setting FISA1=SCALE the set maximum torque is reduced from 0% (0 V) - 100% (10 V).
2. Torque limitation by means of parameter 805-SCALE
 With this setting the set maximum torque is reduced from 0% - 100%.
 The parameter is permanently stored, i. e. after switching the mains supply on the setting is always 100%.
 With this function the maximum torque can be dynamically changed via field bus or PLC.

If the analog input is set to FISA1=SCALE, setting the parameter 805-SCALE will have no effect.

Function	Value range	WE	Data types	Parameters
Torque scaling	0.00 ... 100.00 %	100.00	fixpoint16 (RAM)	805_SCALE (_CTRL)

6.2.3 Stop ramps

Function	Effect
<ul style="list-style-type: none"> • Deceleration ramps in dependence on various system conditions <ul style="list-style-type: none"> – Switch of closed-loop control – Stop feed – Quick stop – Error 	<ul style="list-style-type: none"> • Different ramp settings are possible

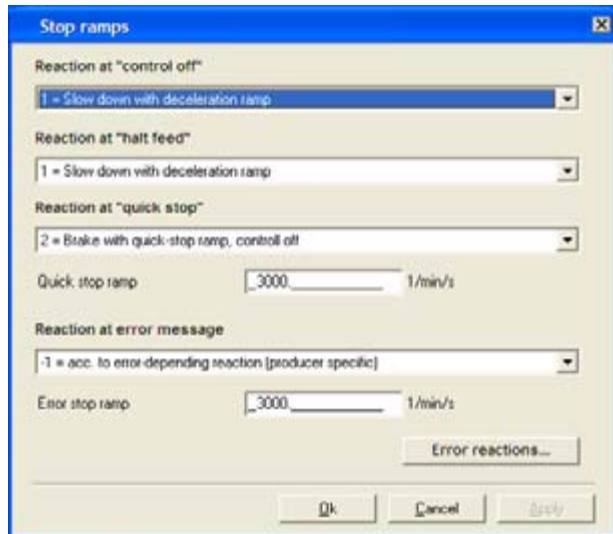

Fig. 6.22 Stop ramp function mask

DRIVEMANAGER	Value range	WE	Unit	Parameters
Reaction with "Control off" - Shutdown Option Code -	-1 ... 1	0		663_SDOPC (_SRAM)
Reaction with "Stop feed" - Stop Option Code -	0 ... 4	1		664_HAOPC (_SRAM)
Reaction at quick stop - Quick Stop Option Code -	0 ... 8	2		661_QSOPC (_SRAM)
Quick stop ramp	0 ... 32760 ¹⁾	3000	rpm	592_STOPR (_SRAM)

DRIVEMANAGER	Value range	WE	Unit	Parameters
Reaction in case of error message - Fault Reaction Option Code -	-1	-1		662_FROPC (_SRAM)
Error stop ramp	0 ... 32760 ¹⁾	3000	rpm	593_ERR_R (_SRAM)

1) A setting of 0 rpm means braking with max. dynamics / max. ramp.

Reactions in case of "Control off"

The condition transition "Control off" is passed through when switching off the output stage. The closed-loop control is shut down via various control channels (terminals, bus, PLC).

BUS	Setting	Reaction
-1	-1	As reaction in case of quick stop
0	0	Lock output stage - drive "runs out"
1	1	The drive brakes with programmed deceleration ramp, the output stage is subsequently locked.

Table 6.12 Setting of reaction with "Control off"

Reaction with "Stop feed"

The status "Stop feed" brakes an ongoing movement, as long as the condition is active. During braking acceleration to the previous status is possible. When deactivated acceleration will take place along the programmed acceleration ramp.

"Stop feed" is triggered by:

Triggering location	HALT switch on	HALT switch off
Terminals	Flxxx = /HALT = 0	Flxxx = /HALT = 1
Field bus	Bit HALT = 1	Bit HALT = 0
PLC	SET HALT = 1	SET HALT = 0

Table 6.13 Triggering locations for HALT

BUS	Setting	Reaction
0	0	No function - please do not adjust
1	1	Braking with programmed deceleration ramp
2	2	Braking with quick stop ramp
3	3	Braking with max. dynamics at the current level. The speed setpoint is set to 0.
4	4	Braking with max. dynamics at the current level. The speed setpoint is set to 0.

Table 6.14 Setting the reactions with HALT

Reactions with quick stop:

Quick stop brakes a running movement. The drive controller is in "Quick stop" state. Acceleration up to the previous state "Technology ready" is possible during the braking process and in dependence on the reaction, as long as the closed-loop control is active.

Quick stop is triggered via:

Triggering location	Quick stop - enable	Quick stop - disable
Terminals	Flxxx = /STOP = 0	Flxxx = /STOP = 1
Field bus	Bit /STOP = 0	Bit /STOP = 1
PLC	SET BRAKE = 1	SET BRAKE = 0

Table 6.15 Quick stop triggering locations

BUS	Setting	Reaction
0	0	Lock output stage - drive "runs out"
1	1	Braking with programmed deceleration ramp, the output stage is subsequently locked.
2	2	Braking with quick stop ramp, the output stage is subsequently locked.
3	3	Braking with max. dynamics at the current level. The speed setpoint is set to 0, the output stage is subsequently locked.
4	4	Braking with max. dynamics at the current level. The speed setpoint is set to 0, the output stage is subsequently locked.
5	5	Braking with programmed deceleration ramp. The drive remains in quick stop state, the axis is energized with speed 0. ¹⁾

Table 6.16 Setting the reactions with quick stop

BUS	Setting	Reaction
6	6	Braking with quick stop ramp. The drive remains in quick stop state, the axis is energized with speed 0. ¹⁾
7	7	Braking with max. dynamics at the current level. The speed setpoint is set to 0. The drive remains in quick stop state, the axis is energized with speed 0. ¹⁾
8	8	Braking with max. dynamics at the current level. The speed setpoint is set to 0. The drive remains in quick stop state, the axis is energized with speed 0. ¹⁾

¹⁾ Transition to the state "Technology ready" is only possible by resetting the quick stop request.
In "Quick stop" state cancelling the signal "Start closed-loop control/drive" has no effect, as long as the quick stop request is not reset as well.

Table 6.16 *Setting the reactions with quick stop*

Reaction with error

The reaction of the error stop ramp always depends on the corresponding error. This is described in chapter 6.9.

6.2.4 Reference encoder/ Master-Slave operation

Encoder

Function	Effect
<ul style="list-style-type: none"> TTL or HTL reference encoder input as setpoint source (Master) Voltageless connection when using the HTL-input on CDB3000 A/B incremental or pulse direction signals Transmission ratio can be set in form of a fraction 	<ul style="list-style-type: none"> Following axis (Slave) Speed and angle synchronous synchronism related to a leading axis (Master) Master-Slave operation

The configuration of the reference encoder input must be set in function "Setpoint/ramps", option "Reference encoder".



Note: The configuration of the reference encoder input uses the same parameters, as the encoder configuration (see chapter 6.4.2), because the hardware interfaces are identical. Changing the reference encoder parameterization thus has a direct influence on the encoder configuration.

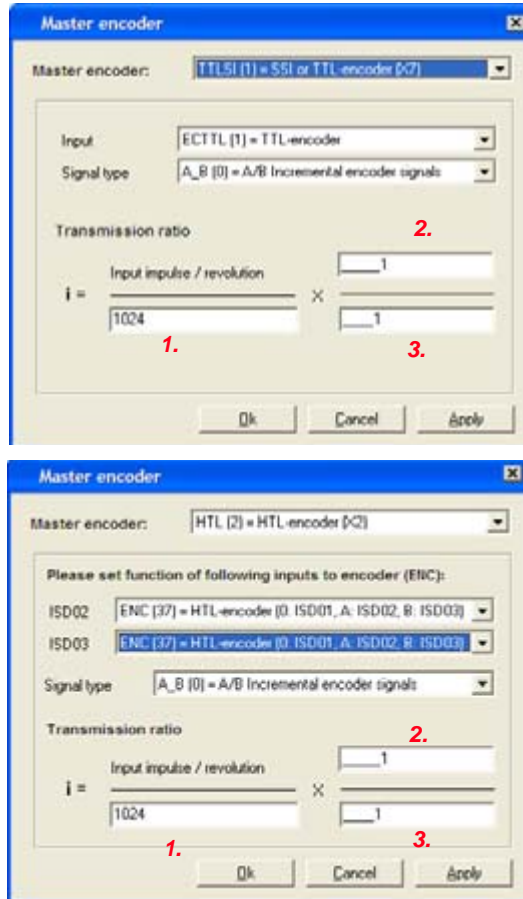

Fig. 6.23 Setting the reference encoder for TTL- (top) and HTL- input (bottom, only for CDB3000)



Note: The figures 1., 2. and 3. are explained in Table 6.19 for the TTL-input and in Table 6.20 for the HTL-input.

Selecting the reference encoder for CDB3000

DRIVEMANAGER	Meaning	Value range	WE	Unit	Parameters
Reference encoder	<p>Selection of the reference encoder channel:</p> <p>OFF (0): Off - No reference encoder needed. The TTL/HTL encoder interfaces can be used for motor encoders.</p> <p>TTL (1): TTL- reference encoder on X7. This input is not voltageless with respect to the control electronics of the controller.</p> <p>HTL (2): HTL- reference encoder on control terminal X2. Voltageless input.</p>	OFF (0) - HTL (2)	OFF (0)	-	475-CFREC (_ENC)

Table 6.17 Selecting the reference encoder for CDB3000

Selecting the reference encoder for CDE/CDF3000

DRIVEMANAGER	Meaning	Value range	WE	Unit	Parameters
Reference encoder	<p>Selection of the reference encoder channel:</p> <p>OFF (0): Off - No reference encoder needed. The TTL/HTL encoder interfaces can be used for motor encoders.</p> <p>X6 (1): No function</p> <p>X7 (2): TTL- reference encoder on X7. This input is not voltageless with respect to the control electronics of the controller.</p>	OFF (0) - X7 (2)	OFF (0)	-	475-CFREC (_ENC)

Table 6.18 Selecting the reference encoder for CDE/CDF3000

Configuration of a TTL- reference encoder

DRIVEMANAGER	Meaning	Value range	WE	Unit	Parameters
input	<p>Input configuration on X7: CDB3000: ECTTL (1): CDE/CDF3000: ECTTL (4): The input is evaluated as TTL-encoder. The index signal of the encoder is not evaluated in the "Reference encoder" function. All other parameter settings are invalid for the reference encoder configuration. These are reserved for motor code setting or Master/Slave-coupling.</p>	<p>CDB3000: OFF (0) - SSISL (4) CDE/CDF3000: OFF(0) - SSIMS(7) here only ECTTL valid</p>	<p>CDB3000: ECTTL (1) CDE/ CDF3000: ECTTL (4)</p>	-	438-CFX7 (_ENC)
Signal type	<p>A_B (0): Two 90 phase-displaced incremental signals A/B serve as input signals A_DIR (1): Track A is the clock input. Track B defines the direction of counting or rotation (Low: clockwise, High: anti-clockwise)</p>	A_B (0) - A_DIR (1)	A_B (0)	-	484-ECST1 (_ENC)
Ratio - input pulse/ revolution (1.)	Reference encoder pulses	32 - 8192	1024	-	432-ECLN1 (_ENC)
Ratio - numerator (2.)	Numerator for ratio between leading and following axis. If leading and following axes are be counter-rotating, a negative numerator must be entered. The numerator can be changed online.	-32768 - 32767	1		435-ECN01 (_ENC)
Ratio - denominator (3.)	Denominator for ratio between leading and following axis. The denominator can be changed offline (controller off)	0 - 65535	1		436-ECDE1 (_ENC)

Table 6.19 Configuration of a TTL- reference encoder

Configuration of a HTL- reference encoder with CDB3000

The digital inputs ISD02 and ISD03 must be set to "Encoder input ENC (37)".

DriveManager	Meaning	Value range	WE	Unit	Parameters
Signal type	A_B (0): Two 90 phase-displaced incremental signals A/B serve as input signals A_DIR (1): Track A is the clock input. Track B defines the direction of counting or rotation (Low: clockwise, High: anti-clockwise)	A_B (0) - A_DIR (1)	A_B (0)	-	483-ECST2 (_ENC)
Ratio - input pulse/ revolution (1.)	Reference encoder pulses	32 - 8192	1024	-	482-ECLN2 (_ENC)
Ratio - numerator (2.)	Numerator for ratio between leading and following axis. If leading and following axes are counter-rotating, a negative numerator must be entered. The numerator can be changed online.	-32768 - 32767	1		480-ECN02 (_ENC)
Ratio - denominator (3.)	Denominator for ratio between leading and following axis. The denominator can be changed offline (controller off)	0 - 65535	1		481-ECDE2 (_ENC)

Table 6.20 Configuration of a HTL- reference encoder

Reference encoder in speed controlled operation

For speed regulation with reference encoder setpoint source no preset solution is available. You should therefore select a preset solution, which, in any case, complies with the desired control location (e. g. terminal or field bus). Then select the setting "RDIG (4)" from the function mask "Setpoint/ramp - further settings" instead of the specified setpoint source. Fig. 6.24 shows the structure of the selected setpoint preparation.

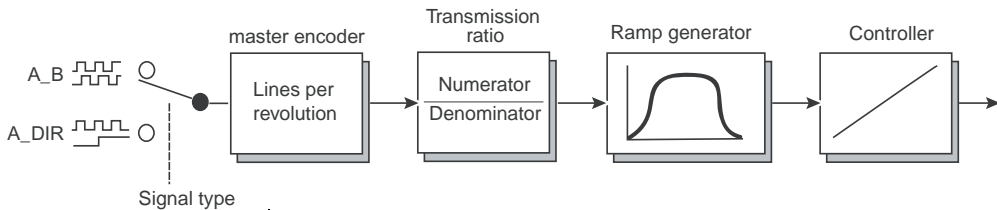

Fig. 6.24 Structure of setpoint preparation with reference encoder as speed setpoint source

The speed setpoint in rpm is smoothened by means of the speed profile generator (see chapter 4.2.1). The function "/HALT- feed/speed release" can be used to couple or decouple the following axis via digital input or field bus, when the motor control is active.

The speed setpoint of the reference encoder always refers to the motor shaft. When using a gearbox on motor and target and the drive shaft speed is to be determined by the reference encoder, the gearbox ratio must be parameterized in the reference encoder configuration.

The speed synchronism can also be activated via PLC (see chapter 7.3.2 - "Speed synchronism" on page 7-36). Further possibilities for adapting the setpoint source can be found in chapter 6.2.5.

Reference encoder in positioning operation (electronic transmission)

In positioning operation synchronous travel with reference encoder setpoint specification is controlled via PLC with special program commands. For this purpose you should select a preset solution with specified setpoint via PLC.

Switching on synchronous travel (coupling):	GOSYN 1
Switching off synchronous travel (decouple):	GOSYN 0

Table 6.21 PLC-commands to control synchronous travel



Note: Switching on synchronous travel occurs abrupt, without limitation of the axis dynamics by ramps. Soft coupling to a moving leading axis is not possible.

The reference encoder position refers to the motor shaft. The unit is always in increments (65536 Incr = 1 motor revolution). If the reference encoder position is to be directly related to the output shaft, the transmission ration must be entered for the reference encoder. A transmission ratio in the standardizing assistant will be ignored when using the reference encoder.

Example for reference encoder configuration with CDB3000:

System structure:

- HTL reference encoder as setpoint specification connected to terminal X2 on CDB3000.
- CDB3000 with gear motor ($i = 56 / 3$)
- A transmission ratio of 56/3 was entered in the standardizing assistant (under basic settings).

Conclusions:

- with a reference encoder transmission ratio of 1/1 the reference encoder setpoint refers to the motor shaft of the gear motor.
- with a reference encoder transmission ratio of 56/3 the reference encoder setpoint refers to the output shaft of the gear motor.

Further information on PLC-programming see chapter 7. Concerning angular synchronism see chapter 7.3.2 - "Angular synchronism (electronic transmission)" on page 7-36.

6.2.5 Setpoint structure - further settings/control location



Function	Effect
<ul style="list-style-type: none"> The setpoint structure adds up both setpoints channels. Each channel can obtain a setpoint source from a fixed selection. There is one setpoint structure each for speed controlled operation and positioning operation. 	<ul style="list-style-type: none"> The setpoint structure is adapted to the application by the preset solution, so that most applications do not require any adaptation. For special applications the internal processing of the setpoint can be adapted through the flexible setpoint structure.

Note: This chapter addresses solely users, who cannot find their particular drive solution or an approach to their solution in the preset solutions.

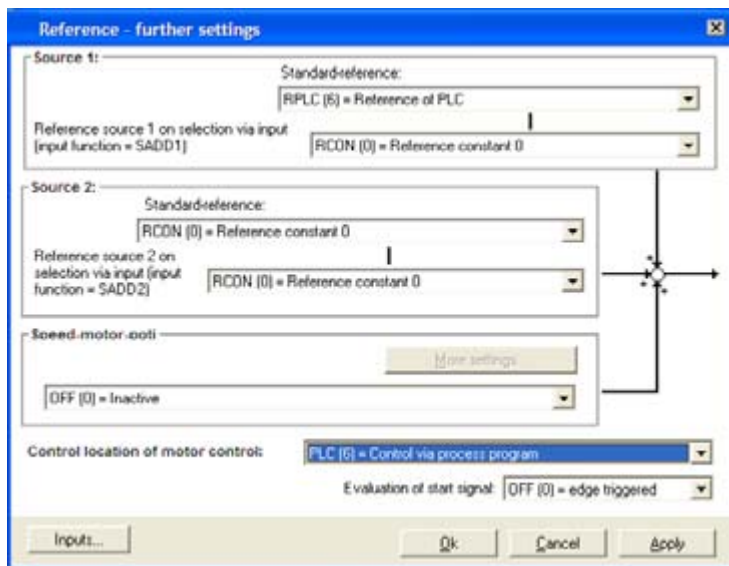

Fig. 6.25 Tab Reference - further settings

The control location for the motor control is described in the separate chapter 6.2.6.

Settings for source 1 / source 2

DRIVEMANAGER	Value range	WE	Unit	Parameters
Standard setpoint	RCON ...ROPT	RA0 RCON		280_RSSL1 281_RSSL2 (_REF)
Setpoint source1, Setpoint source2, when switching over via input	RCON ...ROPT	RCON		289_SADD1 290_SADD2 (_REF)

Settings for RSSL1 / RSSL2 and SADD1 / SADD2:

BUS	Setting	Function
0	RCON	Setpoint constantly zero
1	RA0	Setpoint of analog input ISA00
2	RA1	Setpoint of analog input ISA01
3	RSIO	Setpoint for serial interface
4	RDIG	Setpoint for digital input in Slave-operation
5	RCAN	Setpoint for CAN-interface
6	RPLC	Setpoint for PLC
7	RTAB	Setpoint from travel set table
8	RFIX	Setpoint of fixed value
9	RMIN	Setpoint of minimum value
10	RMAX	Setpoint of maximum value
11	ROPT	Setpoint for communication module
12	RPARA	Setpoint for parameter interface

The following section describes the corresponding setpoint structures for torque/speed control and positioning.



Symbol	Meaning
	Setpoint source (input), partly with second characteristic set
	Setpoint selector (switch)
	Parameters

Table 6.22 Symbols used in the block diagrams



Symbol	Meaning
	Intermediate setpoints (for display only)
	Limitation of setpoint
	mathematical influence

Table 6.22 Symbols used in the block diagrams

1

2

3

4

5

6

7

8

A

Block diagram of setpoint specification (position control)

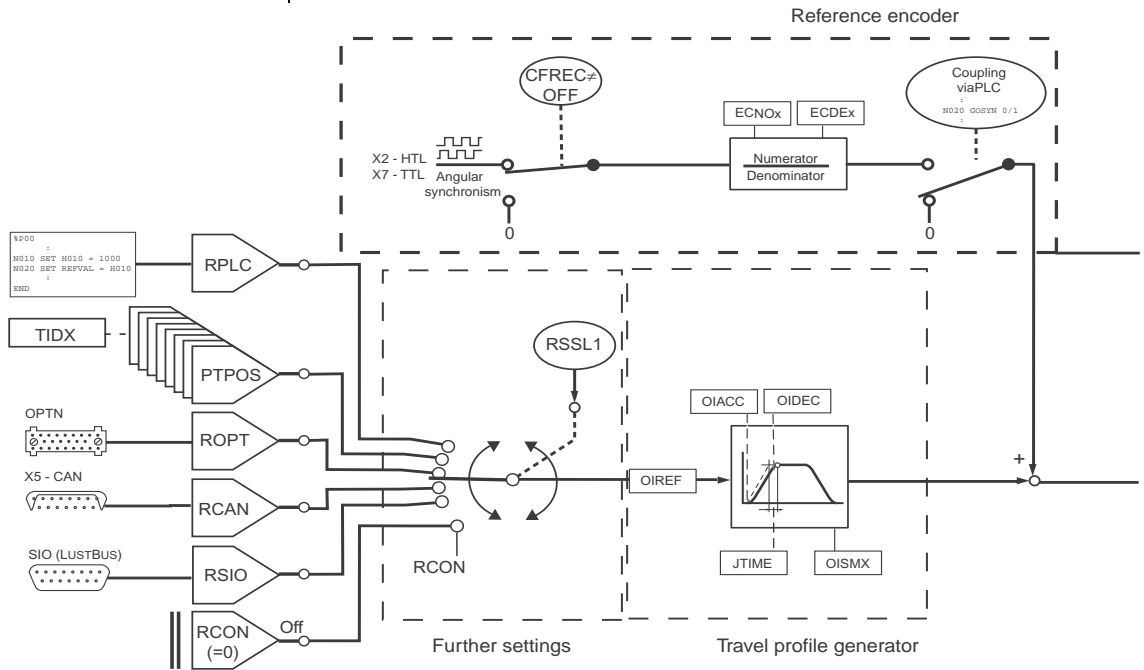

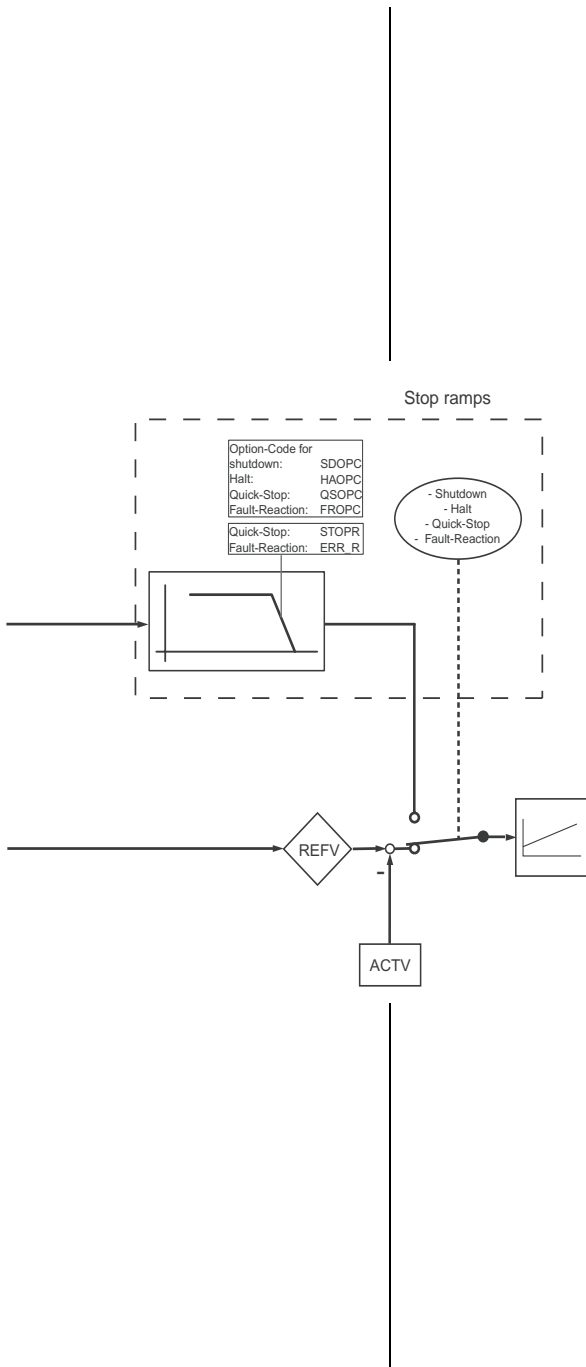

1

2

3

4

5

6

7

8

A

Principle of setpoint specification (speed/torque control)

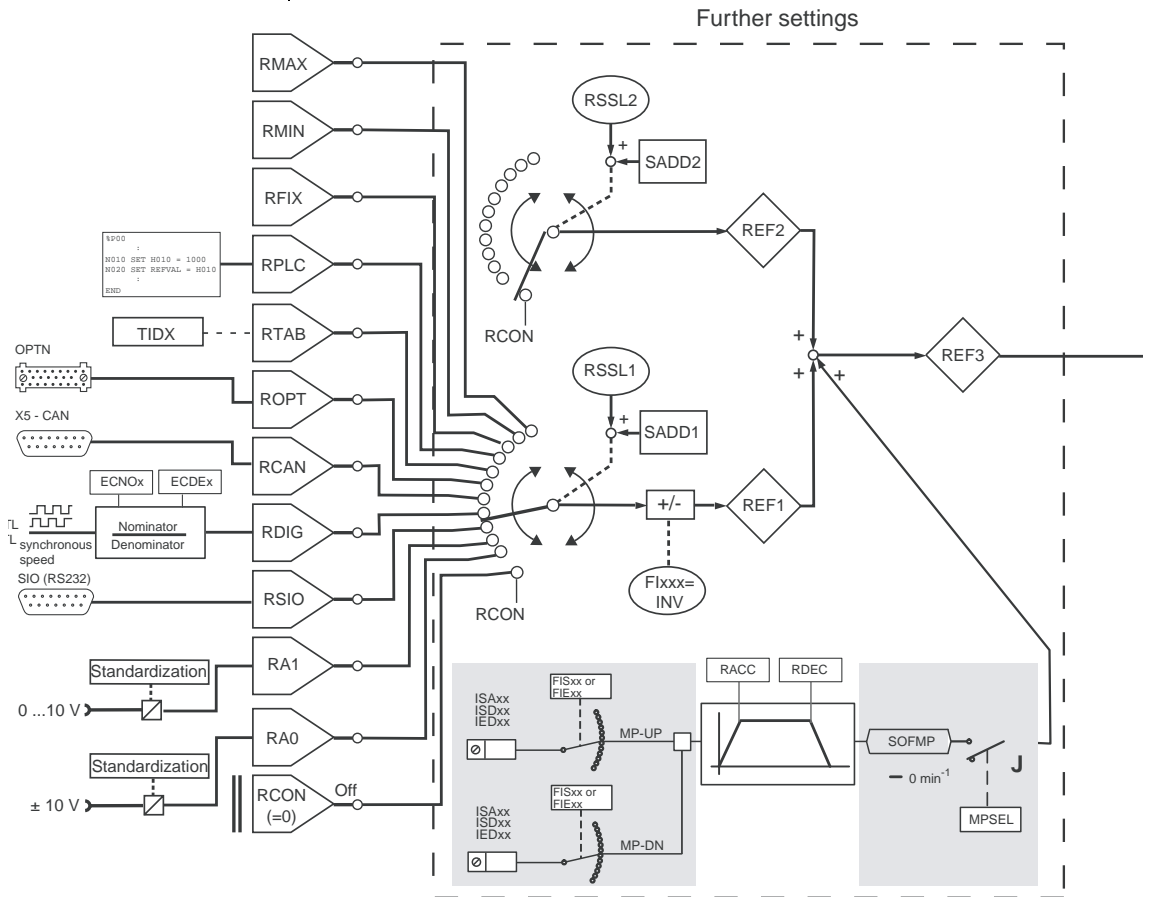

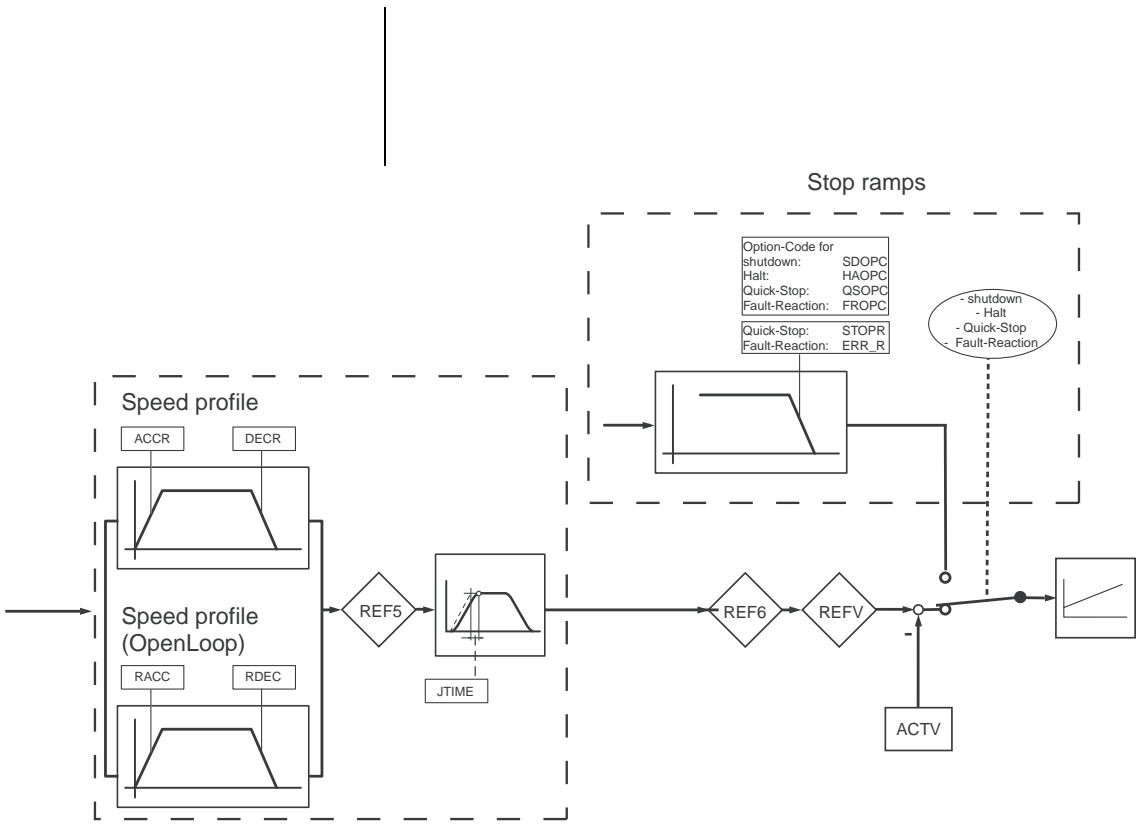

- 1
- 2
- 3
- 4
- 5
- 6
- 7
- 8
- A

Further parameters of setpoint structure

Function	Value range	WE	Unit	Parameters
Analog setpoint input ISA00	-32764 ... 32764	0		282-RA0
Analog setpoint input ISA01	-32764 ... 32764	0		283-RA1
Setpoint for serial interface	-32764 ... 32764	0		284-RSIO
Setpoint communication slot	-32764 ... 32764	0		287-ROPTN
CAN bus setpoint	-32764 ... 32764	0		288-RCAN
Setpoint of setpoint selector 1	-32764 ... 32764			291-REF1
Setpoint of setpoint selector 2	-32764 ... 32764			292-REF2
REF1 + REF2	-32764 ... 32764	0		293-REF3
Setpoint after ramp generator	-32764 ... 32764	0		295-REF5
Setpoint after slip	-32764 ... 32764	0		296-REF6

Table 6.23 Parameters of the setpoint structure

6.2.6 Control location

Function	Effect
<ul style="list-style-type: none"> The control location determines the interface for submission of the control command to start the closed-loop control. 	<ul style="list-style-type: none"> The control location is automatically set when choosing a preset solution. Possible control locations are (see Table 6.26): <ul style="list-style-type: none"> - Terminals - Control unit - Serial interface - Optional slot (PROFIBUS), - CAN-interface - PLC

The control location is set with parameter 260-CLSEL (DRIVEMANAGER function mask "Setpoint/Ramps - further settings").

DRIVEMANAGER	Value range	WE	Unit	Parameters
Control location for motor control	OFF ... PLC	TERM		260_CLSEL (_CONF)

Table 6.24 Parameter control location

Evaluation of start signal

Prerequisites for starting the controller:

- Hardware release ENPO is set at least 10 ms before setting the start signal (High-Level).
- The device status "Safe Stop" (on CDB3000 only with hardware version "SH") is inactive.

The start signal is evaluated in dependence on the signal level.

Start "flank triggered" (factory setting)

Starting takes place after a Low-High transition of the signal. If the start signal is at High-Level immediately after switching on, the control is not started. A Low-High transition is required first.

Start "Level triggered" (Auto-Start)

Starting takes place when the start signal has High-Level. If the start signal is at High-Level immediately after switching on the mains supply, the control is started.

The function is also used for automatic starting after switching on the main supply. It is switched on by parameter 7-AUTO = ON.



Attention: With Auto-Start the drive starts automatically after Mains On or after resetting an error, depending on the error reaction.

Function	Meaning	Value range	WE	Parameter
Auto-Start	OFF: Start Low-High-flank triggered ON: Start "Level triggered"	OFF/ON	OFF	7-AUTO (_CONF)

Table 6.25 Parameter Auto-Start



Fig. 6.26 Setting of Auto-Start function with selection via terminal (TERM)

Setting of control location selector 260-CLSEL

BUS	KEYPAD/ DRIVEMANAGER	Function
0	OFF	no function
1	TERM	Control via terminal strip
2	KPAD	Control via KEYPAD
3	SIO	serial interface RS232 (Serial Input Output)
4	CAN	Control via CANopen interface
5	OPTN	Control via communication module
6	PLC	Control via sequencing program
7	PARAM	Control via parameter interface - NO FUNCTION -

Table 6.26 Settings for 260-CLSEL control location selector

Terminals (TERM)

To start the controller in control mode "Terminal" a digital input must be parameterized to Flxxx = START.

With the settings Flxxx = STR, STL a start command can be specified for a direction of rotation. The start commands are thereby decisive for the sense of rotation.

In order to save an input, the start function with Auto-Start can also be parameterized to a virtual input. The controller is in this case started by setting the hardware release ENPO.

Operation panel KeyPAD KP200-XL (KPAD)

In the CONTROL menu the operation panel completely takes over the controller. It sets the control location selector and the setpoint channel 1 to KP200-XL. The second setpoint channel is disabled.

With the operation panel one can take over the control of the closed-loop control and specify a signed setpoint to determine the sense of rotation



Note: The operation panel KP200-XL is connected to the CDF3000 using an additional interface cable.

Serial interface (SIO)

A special bus protocol is used to control the positioning controllers via the serial interface (terminal X4). The operating software DRIVEMANAGER uses this protocol for communication and control of the positioning controllers.

As soon as the DRIVEMANAGER function "Control device" is called up, the control location is set to SIO.

Once the end of the control window is reached, the DRIVEMANAGER resets the original parameter setting.



Note: If the communication between positioning controller and DRIVEMANAGER is interrupted, the setting cannot be reset by the DRIVEMANAGER.

CANopen-interface (CAN)

The positioning controller is controlled via a device internal CANopen interface. Control modes according to the CANopen device profile DSP402 and the manufacturer specific protocol EASYDRIVE are available.

Optional slot (OPTN, e.g. PROFIBUS)

The control of the positioning controller via communication modules can take place through the manufacturer specific protocol EASYDRIVE.

The control location is set to OPTN.

Sequential program (PLC)

When controlling the positioning controller via PLC, the control location is set to PLC.

6.2.7 Motor potentiometer function

Function	Effect
<ul style="list-style-type: none"> With two inputs the setpoint can be raised or reduced in a linear way 	<ul style="list-style-type: none"> Simple adaptation of motor speed to process

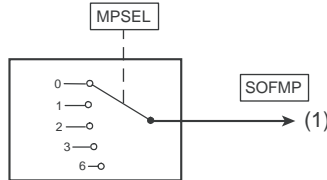

(1) active motor potentiometer function in setpoint source FPOT

Fig. 6.27 Function block motor potentiometer function selector

The motor potentiometer function can be parameterized in two ways:

- Via function mask "Inputs" (Flxxx = MP_xx) and the corresponding options function
- Via function mask "Setpoint/ramps - further settings"

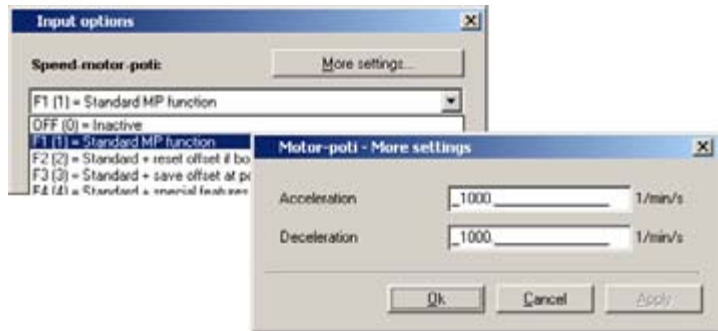

Fig. 6.28 Setting the motor potentiometer function via function mask "Inputs - Options"

Parameters for motor potentiometer function

DRIVEMANAGER	Function	Value range	WE	Unit	Parameter
Speed motor potentiometer	Configuration for motor potentiometer function Settings see Table 6.28	0 ... 6	0 (OFF)		640_MPSEL (_VF)
Acceleration (Further settings)	Acceleration ramp for motor potentiometer function	0 ... 32760	1000	min ⁻¹ /s	641_MPACC (_VF)
Deceleration (Further settings)	Deceleration ramp for motor potentiometer function	0 ... 32760	1000	min ⁻¹ /s	642_MPDCC (_VF)
	Display of current offset speed SOFMP	-32764 ... 32764	0	rpm	643-SOFMP (_VF)

Table 6.27 Parameters for motor potentiometer function

Settings for motor potentiometer function 640-MPSEL

BUS	KP/DM	Function
0	OFF	no function
1	F1	Raising or lowering the speed within the speed range (limits \pm MOSNM x SCSMX(%)) with inputs MP_UP and MP_DN.
2	F2	Raising or lowering the speed within the speed range (limits \pm MOSNM x SCSMX(%)) with inputs MP_UP and MP_DN. If both inputs are set at the same time, the offset speed is reset to 0 min ⁻¹ .
3	F3	Raising or lowering the speed within the speed range (limits \pm MOSNM x SCSMX(%)) with inputs MP_UP and MP_DN. In case of a mains failure the offset speed is saved.
4	F4	Raising or lowering the speed within the speed range (limits \pm MOSNM x SCSMX(%)) with inputs MP_UP and MP_DN. If both inputs are set at the same time, the offset speed is reset to 0 min ⁻¹ . In case of a mains failure the offset speed is saved.
5	F5	Raising or lowering the speed within the speed range (limits \pm MOSNM x SCSMX(%)) with inputs MP_UP and MP_DN. When cancelling the start command, the offset speed is reset to 0 min ⁻¹ .
6	F6	Raising or lowering the speed within the speed range (limits \pm MOSNM x SCSMX(%)) with inputs MP_UP and MP_DN. If both inputs are set at the same time, the offset speed is reset to 0 min ⁻¹ . When cancelling the start command, the offset speed is reset to 0 min ⁻¹ .

Table 6.28 Settings for 320-MPSEL motor potentiometer function

Setting the inputs for motor potentiometer functions



Note: For terminal control the function selector of one digital or analog input (with digital function) must be controlled with

MP-UP = Setpoint up
MP-DN = Setpoint down

(see chapter 6.1.2 "Digital outputs").

Example: Setting F2 of the motor potentiometer function

A digital potentiometer is supplied via two digital inputs. One of the inputs has a reducing effect for the setpoint, the other one raises the setpoint. At the analog input ISA0x a base value can be specified as analog speed setpoint, so that the digital inputs have the effect of an offset. The motor potentiometer function assigns a setpoint to the setpoint source SOFMP.

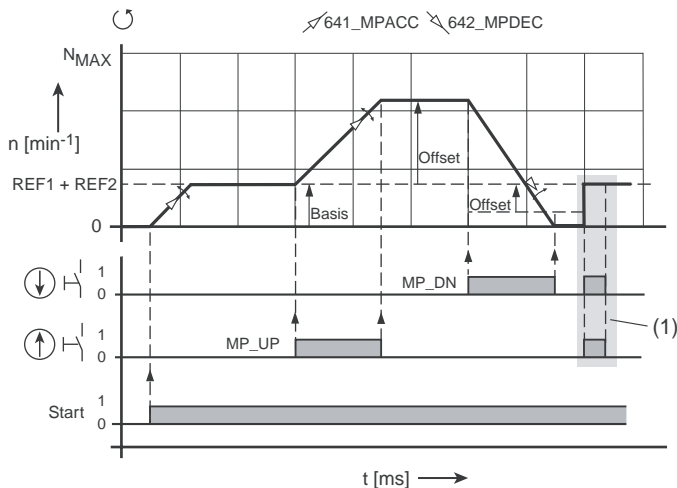

(1) Resetting the setpoint to the base value

Fig. 6.29 Basic function with reset to base value (corresponds with setting F2 in Table 6.28)

**Definitions on
Fig. 6.29**

Basis	analog default speed value at input ISAxx
Offset	Proportion of increase or reduction from the base value, influenced by the inputs with functions MP_UP and MP_DN
ISDxx = MP_UP	Input for offset setting to increase the setpoint
ISDxx = MP_DN	Input for offset setting to reduce the setpoint

1

2

3

4

5

6

7

8

A

6.3 Motor control

Function	Effect
<ul style="list-style-type: none"> • Optimization of controller settings • Adaptation of the controller to the moment of inertia of the system • Setting the switching frequency of the output stage 	<ul style="list-style-type: none"> • Optimal concentricity of the drive

The positioning controller is based on the principle of field oriented controlling. Field orientation means to memorize a current at the location in the motor, at which the field has the biggest size.

The memorized current is thus optimally converted to torque. This results in an optimal utilization of the machine with highest possible dynamics, together with low losses. The result is a very good rate of efficiency.

The digitally controlled drive is most suitable for applications calling for the following characteristics:

- Speed constancy (concentricity)
- Position accuracy
- Dynamics
- constant torque
- Interference compensation

The positioning controller can be operated in three different control modes:

• Torque control	Torque Control	(TCON)
• Speed control	Speed Control	(SCON)
• Position control	Position Control	(PCON)

It has three control circuits, which are superimposed to each other (see illustration Fig. 6.30). Depending on the preset solution, the lower-level control circuits are active, e.g. with speed control only the speed and the

torque controller. The speed setpoint is thereby directly delivered by the setpoint specification, the positioning controller is decoupled and out of function.

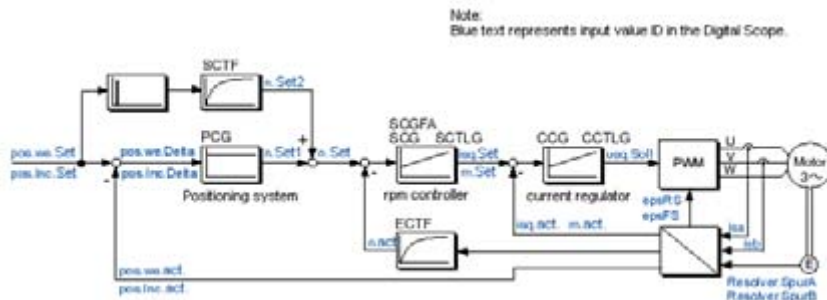
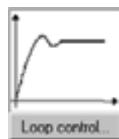

Fig. 6.30 Control structure

Torque and speed controllers are designed as PI-controllers, the positioning controller as P-controller. Amplification (P-proportion) and integral-action time (I-proportion) of the individual controllers can be adjusted. In the operation mask these settings are made in the function mask "Control".

During commissioning the desired preset solution can be simply selected and parameterized with the help of the DRIVEMANAGER. This also includes the setting of the control mode.



The control structure and the parameters to be set are displayed when selecting the setting values "Control" Fig. 6.31. When selecting the tab "Output stage" you can determine the switching frequency of the output stage, see Table 6.29.

2.

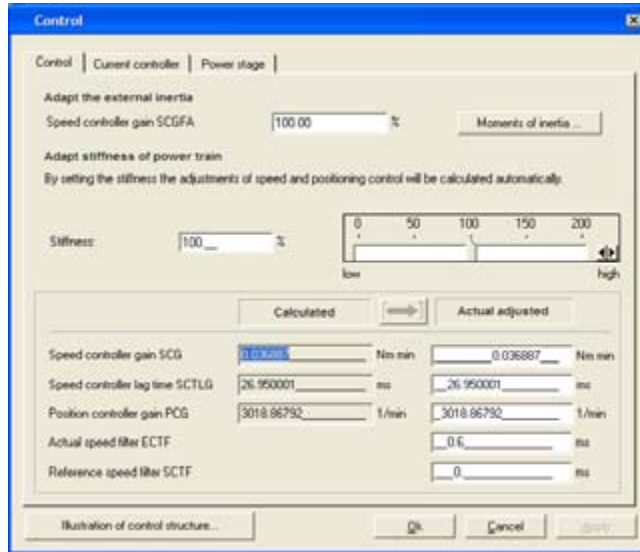

Fig. 6.31 Setting the positioning/speed control

DRIVEMANAGER	Value range	WE	Unit	Parameter
Amplification speed control, scaling factor SCGFA	0 ... 999.95	100.00	%	811_SCGFA (_CTRL)
Moment of inertia of motor (Button "Moments of inertia")	0 ... 100	0	ms	160_MOJNM (_MOT)
Motor of inertia motor+system (Button "Moments of inertia")	0 ... 1000	0	ms	817_SCJ (_CTRL)
SCG: Amplification speed control	0 ... 1000000000	0.035	Nm min	810_SCG (_CTRL)
SCTLG: Integral-action time speed control	1 ... 2000	12.6	ms	812_SCTLG (_CTRL)
PCG: Amplification positioning control	1 ... 32000	4000	rpm	473_PCG (_CTRL)
ECTF: Filter actual speed value	0 ... 100	0.6	ms	818_ECTF (_CTRL)
SCTF: Filter speed setpoint	0 ... 1000	0	ms	816_SCTF (_CTRL)

DRIVEMANAGER	Value range	WE	Unit	Parameter
Reduction of speed control amplification	0.00 ... 100.00	50.00	%	809_SCGFO (_CTRL)
Power stage switching frequency (Tab "Output stage")	4KHZ (0)...16KHZ (3)	8KHZ (1)	kHz	690_PMF5 (_CONF)

Setting the switching frequency (parameter PMFS):

BUS	Setting	Function
0	4KHZ (0)	4 kHz
1	8KHZ (1)	8 kHz
2	12KHZ (2)	12 kHz
3	16KHZ (3)	16 kHz

Table 6.29 Output stage switching frequency

Depending on the application the following steps must be performed to set the speed control circuit:

- Adaptation of the speed control amplification to the existing external inertia.

For this purpose one can either enter the known moment of inertia directly in the function mask (button "Moments of inertia"), or the speed control amplification can be changed in percent (SCGFA in %).

The moment of inertia for the system must thus be reduced to the motor.

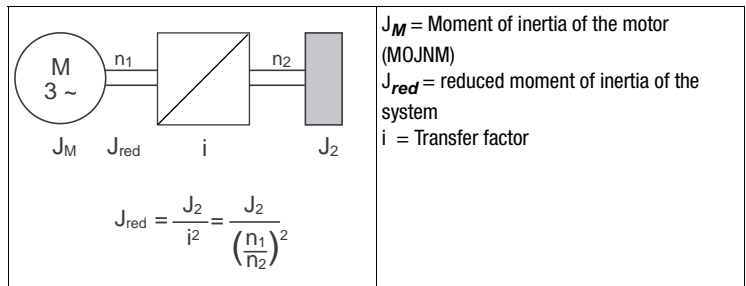

Fig. 6.32 Reduction of the moment of inertia

- Adaptation to the stiffness of the drive line:

This is possible in two different ways. The control circuits can either be parameterized or the adaptation can be made through an assistant. In the assistant the stiffness can be specified in percent and the

newly calculated values can be transferred to the controller setting. A value of <100% results in a "soft" controller setting (e.g. for a toothed belt drive), whereas a value of >100% causes a "hard" controller setting for hard mechanics (free of clearance and elasticity).

The torque/current controller is optimally adjusted to the respective motor by means of the motor data set or the identification. The tab "Current controller" is available for adaptation and testing by means of a test signal.

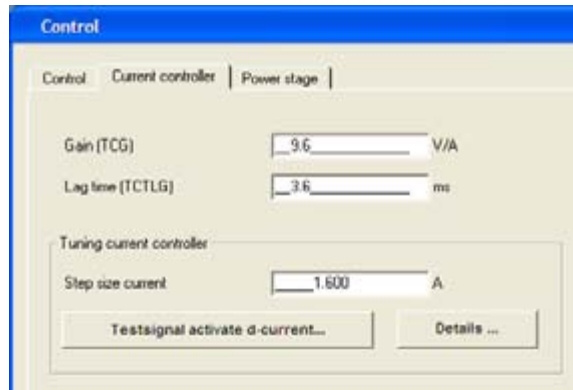

Fig. 6.33 Function mask for setting the current controller

DRIVEMANAGER	Value range	WE	Unit	Parameter
Amplification (CCG)	0 ... 500	1	V/A	800_CCG (_CTRL)
Integral-action time (CCTLG)	0,1 ... 100	3,6	ms	801_CCTLG (_CTRL)

6.4 Motor and transducer



The motor data are required for controlling the motor. For this purpose you must select the mask "Motor and encoder".



The setting takes place in four stages:

1. Motor data
2. encoder
3. Motor protection
4. Brake

6.4.1 Motor data

Function	Effect
<ul style="list-style-type: none"> • Setting of motor data on the basis of existing data sets or, in case of asynchronous motors, motor identification. 	<ul style="list-style-type: none"> • Optimal operative behaviour of the motor

The electric motor data and the associated optimal controller setting can be set in two different ways.

1. Motor database
A database with the settings for all motors is available for motors from Lust Antriebstechnik GmbH.
2. Motor identification for asynchronous motors with CDB3000
For unknown motors the motor identification on the basis of types plates can be performed with the DRIVEMANAGER.

2.

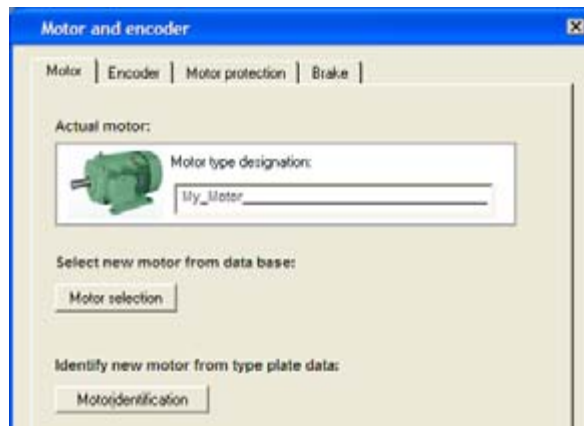

Fig. 6.34 Motor and encoder

In both cases a presetting is determined for the controller, which is based on the following assumptions:

- The torque controller is set up optimally, so no further adjustments are necessary.
- The setting of the speed controller is based on the assumption that the moment of inertia of the machine reduced to the motor shaft is equal to the moment of inertia of the motor.
- The position controller has been designed for elastic coupling to the mechanics.
- Optimizations can be made according to chapter 6.3 - "Motor control".

Motor database

If the data for the motor to be used are available in a database of the DRIVE MANAGER, these can be selected via the option "Motor selection" and transferred to the device.

A database with the settings for all motors (without encoder information) is available for motors from Lust Antriebstechnik GmbH. Using the correct motor dataset ensures:

- that the electrical data of the motor are correctly parameterized,
- that the motor protection (tab "Motor protection") is correctly set and
- the control circuits for the drive are preset.

Motor databases for motors from Lust Antriebstechnik GmbH are not part of the DRIVEMANAGER or its installation. The motor databases are separately stored on the DRIVEMANAGER installation CD-ROM and can be installed from there. Up-to-date versions can be downloaded from the website <http://www.lust-antriebstechnik.de>. The "Setup" installs the motor database into the default directory of the DRIVEMANAGER.

If a motor dataset is supplied on a data carrier (floppy disk, CD-ROM) it can be directly loaded via button "Other directory".



Attention: When selecting motor data from the database it must be assured that both the nominal data as well as the wiring are in accordance with the application. This applies in particular for rated voltage, speed and frequency.

Motoridentification

Motor identification for asynchronous motors with CDB3000:

If the motor data for the respective motor are not available, the motor can be measured using the option "Motor identification" to calculate the controller setting.

As a prerequisite for successful motor identification the motor power must be lower than or equal with the the converter power, but should be at least quarter of the converter power.

Setting the nominal motor data

For the purpose of motor identification the nominal data of the motor must be specified in the mask Fig. 6.35.

Fig. 6.35 Motor identification

Setting the motor data:

DRIVEMANAGER	Value range	WE	Unit	Parameter
Type designation motor	max. 25 digits	-	-	839_MONAM (_MOT)
1. Rated voltage	0 ... 1000	230	V	155_MOVNM (_MOT)
2. Rated current	0.1 ... 64	2.95	A	158_MOCNM (_MOT)
3. Rated speed	0 ... 100000	1500	rpm	157_MOSNM (_MOT)
4. Rated frequency	0.1 ... 1600	50	Hz	156_MOFN (_MOT)
5. Rated power	0.02 ... 1000000	0.57	kW	154_MOPNM (_MOT)
6. Rated torque (only with synchronous servo motors)	0.001 ... 5000	4.1	Nm	852_MOMNM (_MOT)

The moment of inertia of the motor is of relevance for the setting of the speed control.

If the moment of inertia of the motor is known, it is recommended to enter this before starting the motor identification. The controller parameters are adapted accordingly.

DRIVEMANAGER	Value range	WE	Unit	Parameter
Moment of inertia of motor	0 ... 100	0	kgm ²	160_MOJNM (_MOT)

Select "No" if the moment of inertia is unknown. A "0" is entered as moment of inertia (160-MOJNM=0). The motor data are then used to determine a moment of inertia suitable for an IEC-standard motor. The moment of inertia of the motor depends on the number of pole pairs and the related rotor design. The moment of inertia of standard three-phase current motors with squirrel-cage rotor (acc. to DIN VDE 0530, 1000 min⁻¹, 6-pole, 50 Hz and self-ventilated), saved in the positioning controller, are shown in Table 6.45.

Power P [kW]	Moment of inertia J _M [kgm ²]
0,09	0,00031
0,12	0,00042
0,18	0,00042

Table 6.30 Basic values for the moment of inertia related to a six-pole IEC-standard motor

Power P [kW]	Moment of inertia J_M [kgm ²]
0,25	0,0012
0,37	0,0022
0,55	0,0028
0,75	0,0037
1,1	0,0050
1,5	0,010
2,2	0,018
3,0	0,031
4,0	0,038
5,5	0,045
7,5	0,093
11	0,127
13	0,168
15	0,192
20	0,281
22	0,324
30	0,736
37	1,01
45	1,48
55	1,78
75	2,36
90	3,08

Table 6.30 Basic values for the moment of inertia related to a six-pole IEC-standard motor

Performing identification



The ENPO of the device must be set before pressing the button "Start identification".

Note: During self-setting the electric motor circuit must be closed. Contacts must thus only be bridged during the self-setting phase.
If the actuation of the motor contactor is realized via the positioning controller with the function ENMO, the motor contactor will be automatically closed during the identification.

In the steps "Frequency response analysis" and "Measurement of the inductance characteristic" the positioning controller measures the motor and determines the resistance values and the inductances. In the subsequent operating point calculation the flow is adapted in such a way, that the rated speed can be reached and the rated torque (defined via the rated power) is reached at rated speed. If the voltage is found to be too low, the flow is reduced to such an extent, that the speed is reached in any case. The rated torque is automatically reduced. Finally, the control circuits are preset.

After successful motor identification the calculated motor parameters are displayed in the function "Show motor parameters".



Attention: Motor parameters must only be changed by qualified personnel. With an incorrect setting the motor may start unintentionally ("thrashing").

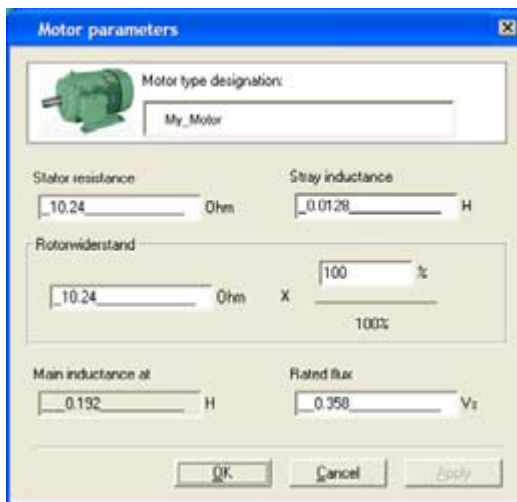

Fig. 6.36 Motor parameters

DRIVEMANAGER	Value range	WE	Unit	Parameter
Primary resistor	0.0 ... 500.0	6.0	Ω	842_MOR_S (_MOT)
Leakage inductance	0.0 ... 10.0	0.018	H	841_MOL_S (_MOT)
Rotor resistance	0.0 ... 500.0	4.2	Ω	843_MOR_R (_MOT)

DRIVEMANAGER	Value range	WE	Unit	Parameter
Rotor resistance scaling factor (120% recommended for rotor resistance with warm motor)	20 ... 300	100	%	837_MORRF (_MOT)
Main inductance (only for display, calculated on basis of rated flow and magnetizing characteristic)	0.0 ... 10000	0.1	H	850_MOL_M (_MOT)
Rated flow	0.0 ... 100.0	0.358	Vs	840_MOFNM (_MOT)

1

2

3

4

5

6

7

8

A

DE

EN

6.4.2 Encoder

Function	Effect
<ul style="list-style-type: none"> Encoder setting Evaluation of up to two encoders 	<ul style="list-style-type: none"> Determination of the motor rotor position Determination of the movement of the connected mechanics

Controlled operation of the drive requires the use of an encoder. Configuration takes place via the tab "Encoder".



Note: This chapter solely describes the setting of the encoders. The specification and acceptability of the encoders as well as their interfaces and connections is described in the operating instructions for the corresponding positioning controllers.

Types of project planning

Project planning with one encoder

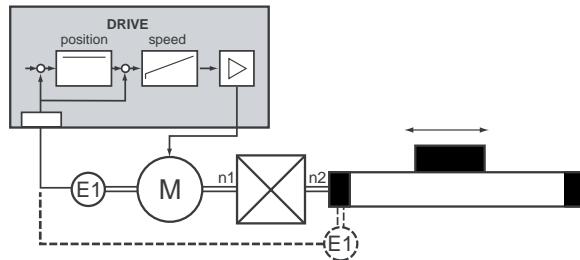

Fig. 6.37 Project planning with one encoder

Two different installation variants are possible:

- Mounting of encoder E1 to the motor
 - Inverting the sense of rotation by using a ratio $n1/n2 = -1/1$ is possible
- Mounting encoder E1 to the mechanics or gearbox output shaft (dashed encoder E1 in Fig. 6.37)
 - Prerequisite is a fixed ratio $n1/n2$ between drive and output, $n1/n2$ must be parameterized.
 - For a sufficient generation of a rotating field a position resolution of at least 7 bit (128 pulses) related to one revolution of the motor shaft is required.

Project planning with two encoders

- Example:
Encoder with 2048 pulses/revolution, $n1/n2 = 10$
=> 204,8 pulses/revolution related to the motor shaft (> 7 bit)
=> o.k.

For compensation of inaccuracies in the mechanics (looseness, play) or for exact determination of the absolute position of the moving mechanics for positioning without referencing, a second encoder E2 can be directly mounted to the mechanics.

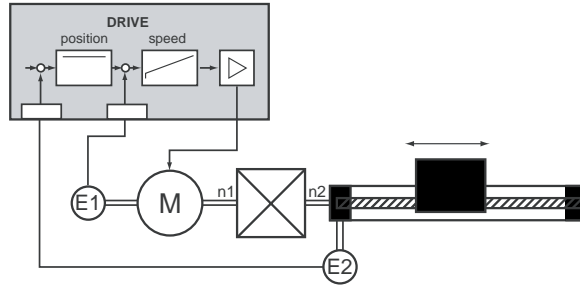

Fig. 6.38 Project planning with two encoders

- Encoder 1 on motor for speed regulation and commutation.
- Encoder 2 on mechanics or gearbox output shaft for position control. The transmission ratio $n1/n2$ must be parameterized.

Encoder for CDB3000

Accepted encoders

The following encoders are evaluated by the CDB3000:

Encoder type	Connection to CDB3000
TTL incremental encoder (TTL)	X7
SSI absolute value encoder (SSI)	X7
HTL incremental encoder (HTL)	X2 (control terminal ISD01-ISD03)
Permitted encoders with the associated connection specification are specified in the CDE/CDB3000 operating instructions!	

Table 6.31 Accepted encoders on CDB3000



Attention: The configuration of the encoders uses the same parameters as the configuration of the reference encoder input (see chapter 6.2.4), because the hardware interfaces are identical. Changing the encoder parameterization thus has a direct influence on the configuration reference encoder.

Selecting the encoder configuration

The encoder configuration is determined at the start.

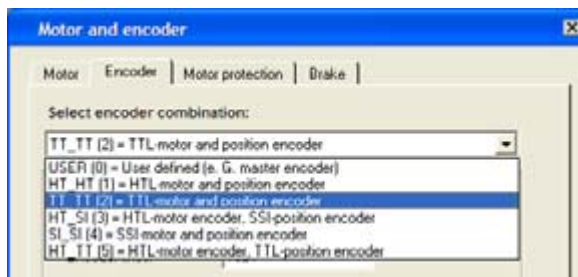

Fig. 6.39 Encoder configuration with CDB3000

Depending on the selection of encoder combinations the following settings can be made:

DRIVEMANAGER	Value range	WE	Unit	Parameter
Selection of encoder combinations	USER ... HT_TT	TT_TT	-	430_ECTYP (_ENC)

Encoder E1	Encoder E2	BUS	Setting	Function
		0	USER	User defined (Is set by the drive, if e.g. the reference encoder has been parameterized)
HTL	-	1	HT_HT	HTL motor and position encoder
TTL	-	2	TT_TT	TTL motor and position encoder
SSI	-	4	SI_SI	SSI motor and position encoder
HTL	SSI	3	HT_SI	HTL motor encoder, SSI position encoder
	TTL	5	HT_TT	HTL motor encoder, TTL position encoder

Encoder settings

For each encoder combination a special function mask is displayed.

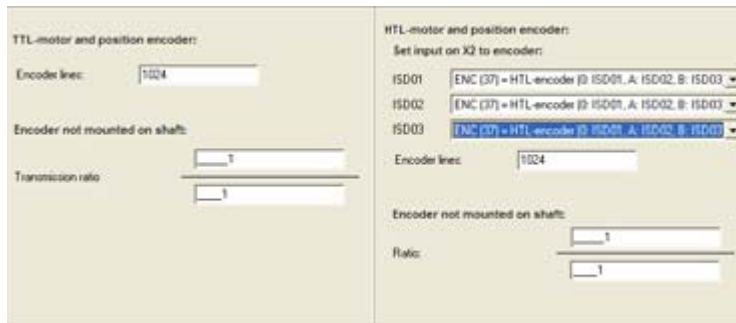

Fig. 6.40 Selection of special function masks for encoder configuration

For HTL-encoders the following parameters must be set:

DRIVEMANAGER	Value range	WE	Unit	Parameter
Lines per revolution (HTL-encoder)	32 ... 8192	1024	-	482_ECLN2 (_ENC)
n1 (numerator)	-32768 ... 32767	1		480_ECNO2 (_ENC)
n2 (denominator)	1 ... 65535	1		481_ECDE2 (_ENC)

Transmission ratio $n2/n1$ (is encoder is not mounted on motor shaft)

Furthermore, the digital inputs for encoder connection must be configured. The connection of track signals A to ISD02 and B to ISD03 is mandatory. Connection of an index signal to ISD01 is optionally possible.

With TTL or SSI encoders the following parameters must be set:

DRIVEMANAGER	Value range	WE	Unit	Parameter
Lines per revolution (TTL-encoder)	32 ... 8192	1024	-	432_ECLN1 (_ENC)
Number of bits Multiturn (SSI encoder)	0 ... 16	12	-	448_SSIMU (_ENC)
Number of bits Singleturn (SSI encoder)	0 ... 20	13	-	447_SISISI (_ENC)
n1 (numerator)	-32768 ... 32767	1		435_ECNO1 (_ENC)
n2 (denominator)	1 ... 65535	1		436_ECDE1 (_ENC)

Transmission ratio $n2/n1$ (is encoder is not mounted on motor shaft)



Attention: Only SSI absolute value encoders as specified in the operating instructions must be used. Setting the number of bits and other settings under the button "SSI-configuration" are reserved for special SSI encoders. Such encoders may only be used after express approval by Lust Antriebstechnik GmbH!

Accepted encoders

Encoder for CDE3000/CDF3000

The following encoders are evaluated by the CDE3000/CDF3000:

Encoder type	Connection to CDE3000	Connection to CDF3000
TTL incremental encoder (TTL)	X7	X6
SSI absolute value encoder (SSI)	X7	X6
Resolver	X6	X6

Accepted encoders with the associated connection specification are specified in the CDE/CDB3000 and CDF3000 operating instructions!

Table 6.32 Accepted encoders on CDE3000/CDF3000



Attention: The configuration of the TTL or SSI encoders uses the same parameters as the configuration of the reference encoder input (see chapter 6.2.4), because the hardware interfaces are identical. Changing the encoder parameterization thus has a direct influence on the configuration of the reference encoder.

Selecting the encoder configuration

The encoder configuration is determined at the start.

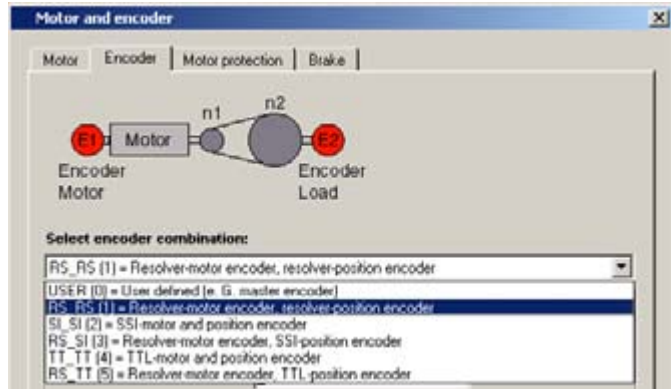

Fig. 6.41 Encoder configuration for CDE3000/CDF3000

Depending on the selection of encoder combinations the following settings can be made:

DRIVEMANAGER	Value range	WE	Unit	Parameter
Selection of encoder combinations	USER ... RS_TT	RS_RS	-	430_ECTYP (_ENC)

Encoder E1	Encoder E2	BUS	Setting	Function
		0	USER	User defined (Is set by the drive, if e.g. the reference encoder has been parameterized)
Resolver	-	1	RS_RS	Resolver motor and position encoder
SSI	-	2	SI_SI	SSI motor and position encoder
TTL	-	4	TT_TT	TTL motor and position encoder
Resolver	SSI	3	HT_SI	Resolver motor encoder, SSI position encoder
	TTL	5	HT_TT	Resolver motor encoder, TTL position encoder

Encoder settings

For each encoder combination a special function mask is displayed.

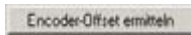

Fig. 6.42 Selection of special function masks for encoder configuration

For resolver encoders the following parameters must be set:

DRIVEMANAGER	Value range	WE	Unit	Parameter
Number of pole pairs, resolver	1 ... 80	1	-	433_ECNP (_ENC)
Encoder offset (see also "Automatic determination of the encoder offset")	0000h ... FFFFh	0000h	-	434_ECOFF (_ENC)
Track signal correction (GPOC) (see also "Track signal correction GPOC")	OFF ... RESET	OFF		685_ECCON (_ENC)

Automatic determination of the encoder offset



For commutation of synchronous motors excited by permanent magnets the rotor position is required before starting the control. The determination therefore uses absolute measuring systems, such as e. g. resolvers. The relation between zero position of the absolute measuring system and rotor position must thereby be known. A possible offset between the zero positions of rotor and encoder is referred to as encoder offset.

For servo motors from Lust Antriebstechnik GmbH it is assured, that the encoder offset is always constant (normally 0h). It has been set in the corresponding motor datasets.



Attention: For the determination of the encoder offset the motor is energized. Rotary movements are thereby possible.

Track signal correction GPOC

Unknown encoder offsets can be detected by means of the DRIVEMANAGER. The button "Determine encoder offset" must be pressed for this purpose.

Resolvers show systematic faults, which are reflected by the measured position and the speed calculated on this basis. Dominant encoder faults are in this case amplification and phase faults, as well as offset proportions of the track signals.

The "Gain-Phase-Offset-Correction" (GPOC) was developed for this purpose. This patented method evaluates the amplitude of the complex pointer described by the track signals, using special correlation methods. The dominant faults can thus be exactly determined and subsequently corrected, without being influenced by other encoder faults.

BUS	KEYPAD/ DRIVEMANAGER	Signal correction function
0	OFF	The track signals are corrected with fixed values. These values are individually determined for each device in the factory. Scattering of the individual encoders cannot be taken into account.
1	ON	The track signals are corrected with fixed values. These values can be determined by the GPOC using the ADAPT mode and stored in the positioning controller.
2	ADAPT	The optimal correction values are determined online with the GPOC. At low speeds the adaptation is switched off, thus to avoid drifting off of the error parameters. The minimum speed for an adaptation is calculated on the basis of (scanning frequency of the control x 60 / 500). With a 4 kHz scanning frequency of the control and a two-pole resolver the adaptation will take place from 480 rpm.
3	RESET	The correction parameters are reset to factory setting. RESET is not set as status, but leaves the current status unchanged.

Table 6.33 Parameter settings 685-ECCON for the signal correction

With TTL or SSI encoders the following parameters must be set:

DRIVEMANAGER	Value range	WE	Unit	Parameter
Lines per revolution (TTL-encoder)	32 ... 8192	1024	-	432_ECLN1 (_ENC)
Number of bits Multiturn (SSI encoder)	0 ... 16	12	-	448_SSIMU (_ENC)

DRIVEMANAGER	Value range	WE	Unit	Parameter
Number of bits Singleturn (SSI encoder)	0 ... 20	13	-	447_SSI1 (_ENC)
Transmission ratio n2/n1 (is encoder is not mounted on motor shaft)				
n1 (numerator)	-32768 ... 32767	1		435_ECNO1 (_ENC)
n2 (denominator)	1 ... 65535	1		436_ECDE1 (_ENC)



Attention: Only SSI absolute value encoders as specified in the operating instructions must be used. Setting the number of bits and other settings under the button "SSI-configuration" are reserved for special SSI encoders. Such encoders may only be used after express approval by Lust Antriebstechnik GmbH!

6.4.3 Motor protection

Function

Effect



- Monitoring of the motor temperature by temperature sensors or thermal switches.

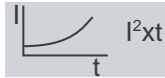

- I^2xt -monitoring. This function replaces a motor protection switch.



- Shut-down with an error message E-OTM, if the motor temperature exceeds the limit value.
- When using a linear temperature sensor the position controllers can emit a warning message at a defined temperature.
- Shut-down with an error message from E-OLM, if the applied current-time value exceeds the limit value.
- The positioning controllers are able to emit a warning message at a defined value of the I^2xt motor protection integrator.



Motor temperature monitoring

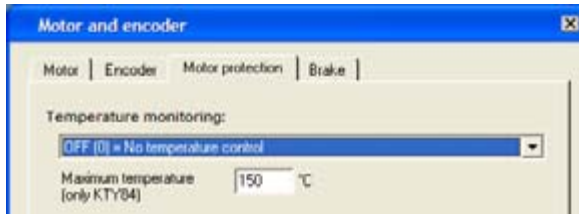

Fig. 6.43 Monitoring of the motor temperature by temperature sensors or thermal switches.

DRIVEMANAGER	Value range	WE	Unit	Parameter
Temperature monitoring (type of motor temperature monitoring)	OFF ... KTY	OFF		330_MOPTC (_MOT)
Maximum temperature (Only for linear PTC (KTY84-130))	10 ... 250	150	°C	334_MOTMX (_MOT)

Setting for parameter MOPTC:

BUS	DRIVEMANAGER	Function
0	OFF	Monitoring switched off
1	KTY	linear PTC (KTY84-130, tolerance band yellow)
2	PTC	Threshold value PTC with short-circuit detection (DIN 44081/44082) - recommended for "Triple-PTC" -
3	TSS	Klixon (normally closed temperature switch)
41	PTC1	Threshold value PTC without short-circuit detection (DIN 44081/44082) - recommended for "Single-PTC" -

Table 6.34 Setting for the type of motor PTC-evaluation MOPTC

Specification of temperature sensor connection X3

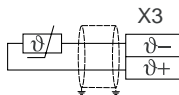

Specification:

- Measuring range max. 12 V
- Measuring range 100 Ω - 15 k Ω
- Short-circuit detection 18 Ω to 100 Ω
- Cycle time 5 ms

Explanations

- The following temperature sensors can be evaluated:
 - linear PTC (KTY84-130, tolerance band yellow)
 - Threshold value PTC (acc. to DIN 44081, DIN 44082)
 - temperature dependent switch (Klixon)
- If the temperature exceeds a limit value, the positioning controller switches the motor off with error message E-OTM. The reaction to the error "Overtemperature motor" can be parameterized. (see chapter 6.9.1).
- With "KTY84 -130"-evaluation the actual motor temperature is displayed in the actual value menu (button "Actual values").
- The „KTY84 -130“-evaluation has an adjustable "Motor temperature" warning threshold, to warn in case of an expected overtemperature shut-down (see chapter 6.9.2).
- With evaluations by means of KTY84-130 the limit value can be set with parameter 334-MOTMX "Maximum temperature".

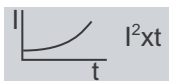

Motor current I^2xt -monitoring

The I^2xt -monitoring protects the motor against overheating over the complete speed range.

This is especially important with self-ventilated motors. In case of longer operation of IEC asynchronous standard motors with low speed the cooling provided by blower and housing is not sufficient. Self-ventilated asynchronous motors thus need a reduction of the maximum permissible permanent current in dependence on the rotation frequency. The rotation is calculated on basis of the actual motor speed.

Correctly adjusted, this function replaces a motor protection switch. The characteristic can be adapted to the operating conditions by means of interpolation points.

2.

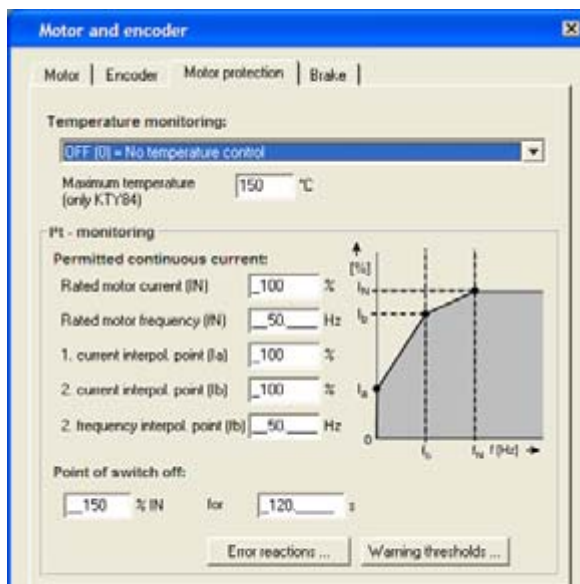

Fig. 6.44 I^2xt -monitoring

DRIVEMANAGER	Meaning	Value range	WE	Unit	Parameter
Permissible permanent current					
Rated motor current	Rated motor current (I_N) for motor protection (related to rated motor current)	0 ... 1000	100	%	335_MOPCN (_MOT)
Rated motor frequency	Rated motor frequency (f_N) for motor protection	0.1 ... 1000	50	Hz	336_MOPFN (_MOT)

DRIVEMANAGER	Meaning	Value range	WE	Unit	Parameter
1. Current interpolation point	1. Current interpolation point (I_a) of the motor protection characteristic (related to the max. characteristic current)	0 ... 1000	100	%	332_MOPCA (_MOT)
2. Current interpolation point	2. Current interpolation point (I_b) of the motor protection characteristic (related to the max. characteristic current)	0 ... 1000	100	%	331_MOPCB (_MOT)
2. Frequency interpolation point	2. Frequency interpolation point (f_b) for motor protection characteristic	0.1 ... 1000	50	Hz	333_MOPFB (_MOT)
Switch-off point (current - time area, maximum integrator value)					
IN	Overload factor (related to rated motor current)	0 ... 1000	150	%	352_MOPCM (_MOT)
for x s	Overload time Maximum time for maximum current	0 ... 600	120	s	353_MOPCT (_MOT)

Motor protection characteristic in factory setting

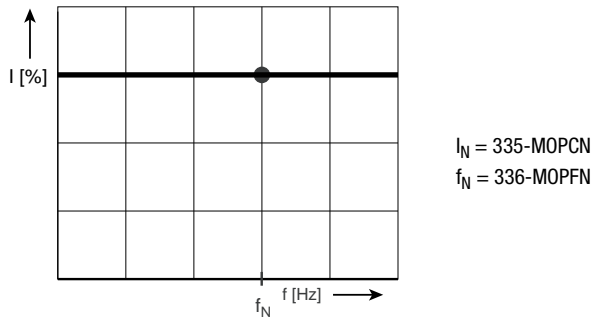

Fig. 6.45 Setting the motor protection characteristic in factory setting

Setting the motor protection characteristic

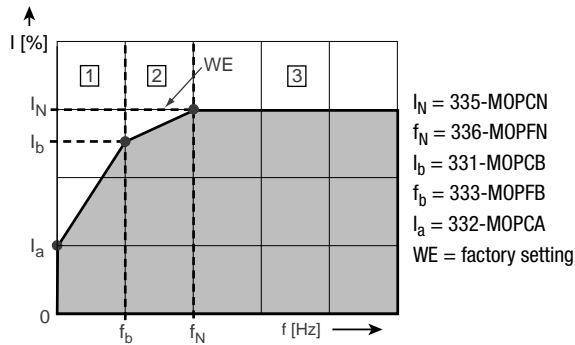

Fig. 6.46 Adaptation of characteristic by means of interpolation points below the rated frequency f_N for e. g. IEC asynchronous standard motors.

Explanations on the adjustment of the motor protection characteristic

- As a rule of thumb the motor protection characteristic or the operation of the IEC asynchronous standard motor should comply with the following limit values, in order to protect the motor.

Frequency (Hz)	Rated motor current (%)
0	30 (I_a)
25 (f_b)	80 (I_b)
50 (f_N)	100 (I_N)

Switch-off point acc. to VDE0530 at 150 % x I_N for 120 s

For servo motors setting a constant characteristic is recommended. The information provided by the manufacturer must be observed.

- The switch-off point defines the permissible current-time area up to switching off. For IEC asynchronous motors the switch-off point acc. to VDE0530 has been set to 150 % of the rated motor current for 120 s. For servo motors the information provided by the manufacturer must be observed.

Explanations on the function of the motor protection characteristic

- As long as the current value at a certain frequency is below the characteristic, the motor is in a safe operating state.
- If the current value at a certain frequency is above the characteristic, the motor is overloaded. The I²t-integrator becomes active. Integration always takes place with the square value of the motor current, according to the equation:

$$I^2t = \int_0^t (I_{Mot}^2 - I_{grenz}^2) dt \quad \text{for } 0 < I^2t < I^2t_{max}$$

- The I²t-integrator starts at 110% of the current limit value of the motor protection characteristic.

$$I_{renz} = 1,1 \times \text{Rated motor current (MOCNM)} \times \frac{I_N}{100\%} \times \frac{I(f)}{100\%}$$

I(f) results from the motor protection characteristic with I_N, I_a, I_b, f_N and F_b:

Condition	Section Fig. 6.46	Calculation I(f)
$ f_{ist} < f_b$	1	$I(f) = \frac{I_b - I_a}{f_b} \times f + I_a$
$f_b \leq f_{ist} < f_N$	2	$I(f) = \frac{I_N - I_b}{f_N - f_b} \times (f - f_N) + I_N$
$f_N < f_{ist} $	3	$I(f) = I_N$

- The limit value of the integrator is defined by a permissible overcurrent

$$\frac{\text{overload factor (MOPCM)}}{100\%} \times \text{Rated motor current (MOCNM)}^2 \times \text{overload time (MOI)}$$

However, this value only applies for the rated point. If the motor protection characteristic had been parameterized, the permissible overcurrent applies for other frequencies over the overload time MOPCT:

$$I_{max}(f) = \frac{\text{Rated motor current (MOCNM)}}{100\%} \sqrt{\text{overload factor (MOPCM)}^2 + I_N^2 \times \frac{I(f)^2 - 100\%^2}{100\%^2}}$$

- If the integrated current time value exceeds the motor dependent adjusted limit value, the positioning controllers switch off the motor with error message E-OLM. The reaction to the error "Ixt shut-down motor" can be parameterized. (see chapter 6.9.1). This function replaces a motor protection switch.
- A "Motor protection" warning threshold to signalize an expected shut-down can be adjusted as a percentage value of the maximum integrator value (see chapter 6.9.2).

Possible motor protections

	A	B	C	D	C+D
Type of overload	Motor protection switch (e.g. PKZM) ¹⁾	Thermistor protection relay	Motor PTC monitoring	Software function "Motor protection"	Motor PTC monitoring and motor protection
Overload in permanent operation ²⁾	●	●	●	●	●
Heavy starting ³⁾	●	◐	◐	●	●
Blocking ²⁾	●	●	●	●	●
Blocking ³⁾	●	◐	◐	●	●
Ambient temperature >50°C ²⁾	○	●	●	○	●
Restriction of cooling ²⁾	○	●	●	○	●
Converter operation <50 Hz	○	●	●	◐	●
○ No protection ◐ Limited protection ● Full protection					

1) Operation in motor line between positioning controller and motor not permitted

2) Controller and motor have the same power rating (1:1)

3) The controller is at least four times the rating of the motor (4:1)

4) Effective with warm motor, too long reaction with cold motor

5) No full protection, because only based on the permissible current.

Table 6.35 Possible motor protections

6.4.4 Motor holding brake

The following software functions are used in both the controlling as well as the regulating modes of operation.

Function	Effect
<ul style="list-style-type: none"> An electro-magnetic holding brake can be triggered in dependence on limit values. Time controlled releasing or applying of the holding brake can optionally be taken into account. 	<ul style="list-style-type: none"> The holding brake closes when falling below a speed limit.

The motor holding brake has the two modes BRK1 (only for U/f-characteristic control) and BRK2.

Parameter settings for the motor holding brake are made with the buttons "Outputs".

1.

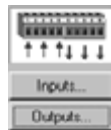

2.

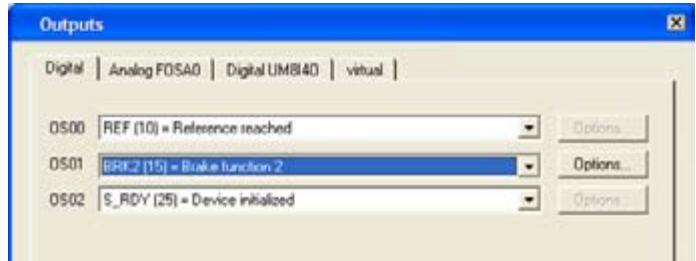

Motor holding brake BRK1

This function can only be used for the U/f-characteristic control. For a controlled variant the BRK2 function is to be used.

The following illustration shows the function of the motor holding brake within the adjustable speed range. The brake can be released in dependence on a setpoint by means of a digital output, that can be set by means of the function selector.

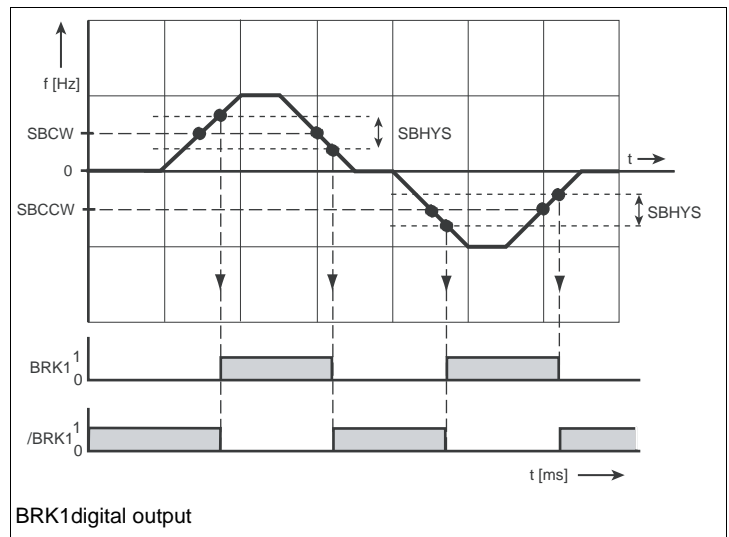
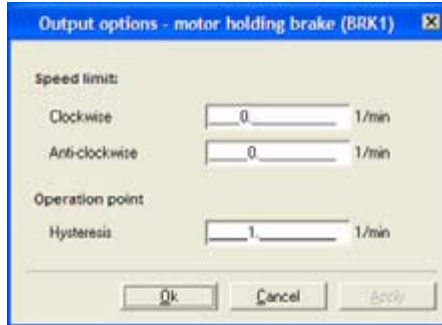

Fig. 6.47 Holding brake speed ranges with setting BRK1

3.



Parameters for motor holding brake BRK1

DRIVEMANAGER	Function	Value range	WE	Unit	Parameter
Clockwise rotation	BRK1: Speed limit for motor brake (clockwise rotation)	0 ... 32764	0	min ⁻¹	310-SBCW (_FEPRM)
Anti-clockwise rotation	BRK1: Speed limit for motor brake (anti-clockwise rotation)	-32764 ... 0	0	min ⁻¹	311-SBCCW (_FEPRM)
Hysteresis	BRK1: Switch-on hysteresis of motor holding brake	-32764 ... 32764	1	min ⁻¹	312-SBHYS (_FEPRM)

Table 6.36 Parameters for motor holding brake BRK1

Explanations

- The speed limit for application/release of the holding brake can be set independently for clockwise and anti-clockwise rotation. The switching hysteresis must be taken into consideration.
- The switching points for the motor holding brake BRK1 are coupled to the setpoint.



3.

Motor holding brake BRK2 for closed loop

The function is activated by selecting the braking function BRK2 through a digital output. The time for release and application of the motor holding brake can be accounted for by means of separate timing elements. The possibility of building up torque is a prerequisite for releasing the brake.

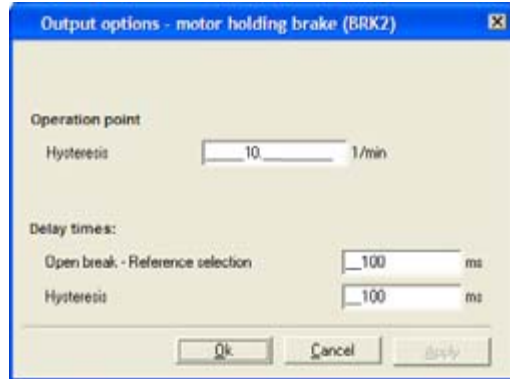

Parameters for motor holding brake BRK2

DRIVEMANAGER	Function	Value range	WE	Unit	Parameter
Hysteresis	-NO FUNCTION-	1 ... 32764	10	min ⁻¹	315-SSHYS (_FEPRM)
Release brake - setpoint specification	Delay of the setpoint specification with motor brake (brake application time)	0 ... 65535	100	ms	316-TREF (_FEPRM)
Apply brake - control off	Delay of deactivating the control with motor brake (releasing the brake)	0 ... 65535	100	ms	317-TCTRL (_FEPRM)

Table 6.37 Parameters for motor holding brake BRK2

Explanations

- The re-parameterization of digital output from or to the setting BRK2 does not work online. For parameterization the output stage must be inactive.
- If the brake control BRK2 is linked with the motor protection control ENMO, the timing element 247-TENMO „Time between motor contactor and active control“ is executed before or after the brake is triggered.

Time diagram for the motor holding brake BRK2

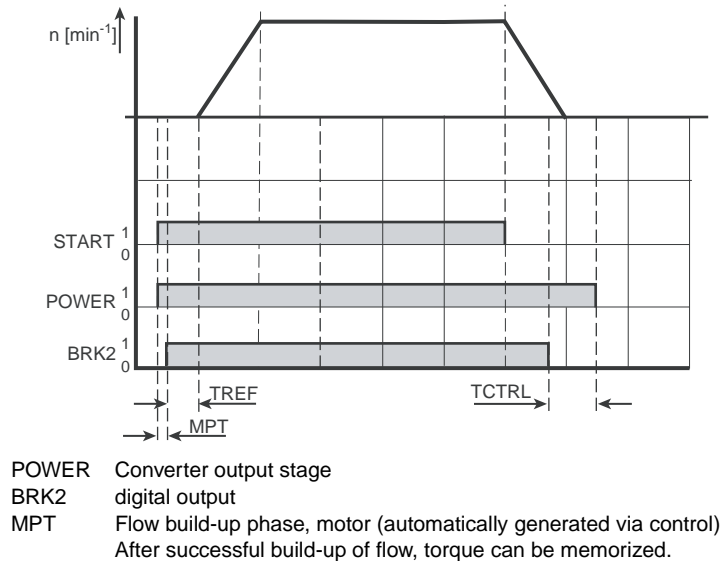

Fig. 6.48 Function of the motor holding brake BRK2

Erläuterungen

- Setpoint $\neq 0 \text{ min}^{-1}$

In the start phase the motor holding brake is switched in dependence on the setpoint. If the current setpoint specification is $\neq 0 \text{ min}^{-1}$, the magnetizing phase for the built-up of flow in the motor is executed over the time MPT. The output = BRK2 subsequently becomes active and the timing element 316-TREF is activated. The time 316-TREF must be parameterized to the brake application time. Upon expiration of the time 316-TREF the brake should be released and acceleration to the specified setpoint should take place. After the time 316-TREF has expired, the functionality of the motor holding brake BRK2, the message „Setpoint reached“ and the standstill detection is determined by the actual value of the rotor.

- Sollwert = 0 min^{-1}

If, with setpoint = 0 min^{-1} the actual value is in the window „Setpoint reached“ of the parameter 230-REF_R in parameterization, standstill of the motor is detected. At the same time the timing element 317-

TREF is started with setpoint specification = 0 min^{-1} . The time 317-TCTRL must be parameterized to the brake application time. After expiration of the time 317-TCTRL the brake must be reliably closed and hold the load. The output stage is subsequently locked.

- In case of fault all outputs are set to LOW and the motor holding brake will close.

1

2

3

4

5

6

7

8

A



Motor holding brake BKRK2 for "OpenLoop" speed control

By selecting the braking function BRK2 via a digital output the corresponding function is activated.

The time for releasing or applying the motor holding brake can be accounted for by using separate timing elements. The switching points of the brake control are triggered in a setpoint dependent way. The build up of torque is enabled by operating the motor at slip speed with the motor holding brake closed.

3.

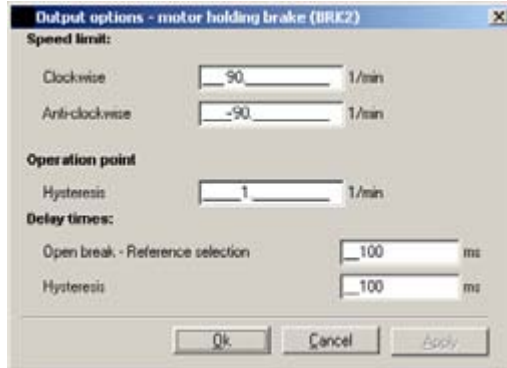

Fig. 6.49 Tab motor holding brake BRK2 for speed control „OpenLoop“

Parameters for motor holding brake BRK2

Erläuterungen

DRIVEMANAGER	Function	Value range	WE	Unit	Parameter
Clockwise rotation	Speed limit of motor holding brake (clockwise) enables torque building with ultimate speed.	0 ... 32764	90	min ⁻¹	636_SSCW (_VF)
Anti-clockwise rotation	Speed limit of motor holding brake (clockwise) enables torque building with ultimate speed.	-32764 ... 0	-90	min ⁻¹	637_SSCCW (_VF)
Hysteresis	- NO FUNCTION -	1 ... 32764	10	min ⁻¹	315-SSHYS (_FEPROM)
Release brake-setpoint specification	Delay of the setpoint specification with motor brake (brake application time)	0 ... 65535	100	ms	316-TREF (_FEPROM)
Apply brake - control off	Delay of deactivating the control with motor brake (releasing the brake)	0 ... 65535	100	ms	317-TCTRL (_FEPROM)

Table 6.38 Parameters for motor holding brake BRK2

Explanations

- The speed limit of speed control "OpenLoop" for releasing the motor holding brake is independently adjustable for clockwise or anti-clockwise rotation. Please consider the hysteresis.
- The speed of clockwise or anti-clockwise rotation is adjusted to the slip speed of the motor.
- The value of the speed hysteresis for the motor holding brake is half the value of the slip of the motor.
- The re-parameterization of a digital output from or to the setting BRK2 does not work online. For parameterization the output stage must be inactive.
- If the brake control BRK2 is linked with the motor protection control ENMO, the timing element 247-TENMO "Time between motor contactor and active control" is executed before or after the brake is triggered.

Time diagram for the motor holding brake BRK2 with speed control „OpenLoop“

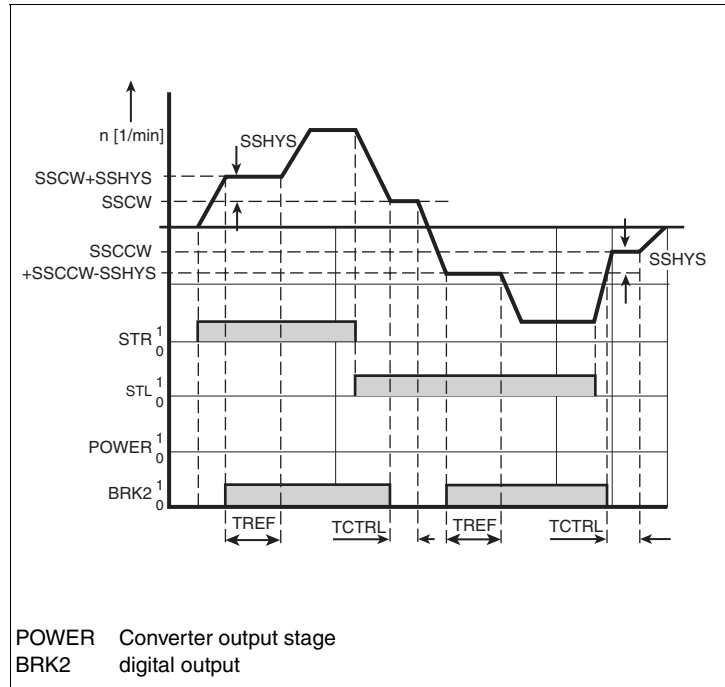

Fig. 6.50 Function of the motor holding brake BRK2 with speed control „OpenLoop“

Explanations

Speed set point > speed limit (SSCW or SSCCW)

- Setting the speed reference above the value "Speed limit + speed hysteresis" the motor accelerates on this value and the brake releases. The reference will be fixed up to expiration of time TREF. Parameterize time TREF to the opening time of the brake.
- After expiration of time TREF the brake shall be released and the reference will be accelerated to the set reference above "Speed limit + speed hysteresis" value.
- The adjustable speed limit will be fixed to the slip speed of the motor, so that the motor builds a torque against the brake. Immediately after releasing the brake a torque for the load is available.

Speed set point > speed limit (SSCW or SSCCW)

- Setting the reference below the adjustable speed limit the drive will be decelerated. Reaching the speed limit closes the brake. Reference will be fixed at the speed limit up to expiration of time TCTRL. Parameterize time TCTRL to the deceleration time of the brake.
- After expiration of time TCTRL the brake shall be closed safely. References below the speed limit, parameterized to the slip speed, results in low torque.
- The brake protect the load, if there is no sufficient torque available during operation of the motor below the slip speed

1

2

3

4

5

6

7

8

A

6.5 Bus systems

1.

Function	Effect
<ul style="list-style-type: none"> Configuration as field bus user 	<ul style="list-style-type: none"> Selection of important settings for the application



The positioning controllers can be integrated into a field bus network. The available bus systems are listed in Table 6.39.

Field bus	possible for positioning controller	Connection	Required documentation for commissioning
CANopen	CDE3000 CDB3000 CDF3000	device internal (standard) via X5	User manual CM-DPV1
PROFIBUS	CDE3000 CDB3000	external communication module CM-DPV1	CANopen user manual

Download of required documentation under <http://www.lust-antriebstechnik.de>

Table 6.39 Possible field bus systems

6.5.1 CANopen

2.

DRIVEMANAGER or KEYPAD are used to set field bus address and baud rate. An operating mode can be additionally selected. Further settings of the field bus configuration solely take place via the field bus system.

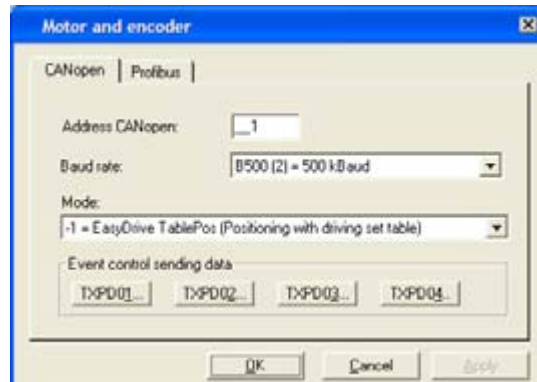



CANopen configuration parameter

The CANopen user manual is required when connecting, commissioning and diagnosing a drive controller in the CANopen network.

DRIVEMANAGER	Function	Value range	WE	Parameter
Address CAN _{open}	Set the software field bus address. The software address is added to the hardware address set with the coding switch	0 ... 127	1	580_COADR (_CAN)
Baud rate	Permissible data transmission frequencies (see Table 6.40).	B_1M ... B10	B500	581_COBDR (_CAN)
Mode of operation	Determination for DSP402 or EASYDRIVE modes with the definition of control and status channel (see Table 6.40). The operating mode is preset when selecting a preset solution.	-4 ... 6	-1	638_H6060 (_CAN)

Baud rate 581-COBDR		
BUS	Setting	Baud rate
0	B_1M	1 MBaud
1	B800	800 kBaud
2	B500	800 kBaud
3	B250	250 kBaud
4	B125	800 kBaud
5	B50	50 kBaud
6	B20	20 kBaud
7	B10	10 kBaud

Operating mode 638-H6060	
Setting	Mode of operation
-4	-
-3	EASYDRIVE ProgPos (PLC control)
-2	EASYDRIVE Basic
-1	EASYDRIVE TablePos (travel set table)
0	-
1	DSP402 - Profile position mode
2	-
3	DSP402 - Profile velocity mode
4	-
5	-
6	DSP402 - Homing Mode

Table 6.40 Setting the CANopen baud rate and operating mode

TxPDO-Event control



The 4 transmission PDOs are sent in asynchronous mode (factory setting, see CANopen user manual) in dependence on one or several events. The events for each individual PDO can be selected from individual function masks, see example in Fig. 6.51. The same event (e. g. input IS02) can be used several times, i.e. with each TX event control.

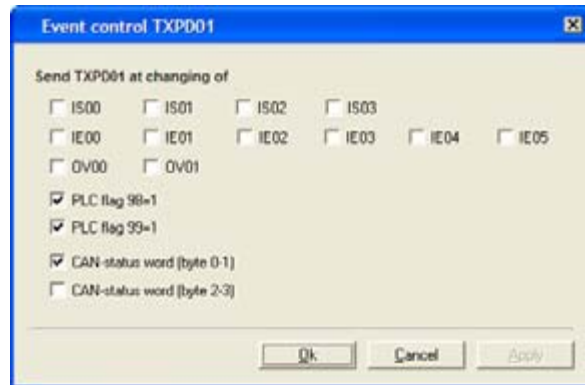

Fig. 6.51 Function mask event control for TxPDO1 with CDB3000

The events are saved bit by bit in the parameters TXEVn (n = 1 ... 4).

DRIVEMANAGER	Function	Value range	WE	Parameter
Button TxPDO1	Events for sending of the first transmission PDO (TxPDO1) Bit by bit coded acc. to Table 6.41	0h ... FFFFh	7000h	148-TXEV1 (_CAN)
Button TxPDO2	Events for sending of the second transmission PDO (TxPDO2) Bit by bit coded acc. to Table 6.41	0h ... FFFFh	7000h	149-TXEV2 (_CAN)
Button TxPDO3	Events for sending of the third transmission PDO (TxPDO3) Bit by bit coded acc. to Table 6.41	0h ... FFFFh	7000h	675-TXEV3 (_CAN)
Button TxPDO4	Events for sending of the fourth transmission PDO (TxPDO4) Bit by bit coded acc. to Table 6.41	0h ... FFFFh	7000h	676-TXEV4 (_CAN)

Bit	Default	TxPDO _n (n = 1 ... 4) send in case of change of ...
0	0	Input IS00
1	0	Input IS01
2	0	Input IS02
3	0	Input IS03
4	0	Input IE00
5	0	Input IE01
6	0	Input IE02
7	0	Input IE03
8	0	Input IE04
9	0	Input IE05
10	0	Virtual output OV00
11	0	Virtual output OV01
12	1	PLC-Flag M98=1
13	1	PLC-Flag M99=1
14	1	CAN status word
15	0	Extended CAN status word (only with EASYDRIVE operating modes)

Table 6.41 Bit by bit coding of parameters TXEV_n

Explanations

- The diagnose of the CANopen control and status word as well as the network status takes place in the function menu "Actual values", tab "CANopen", see chapter 6.8.4.

6.5.2 PROFIBUS

2.

DRIVEMANAGER or KEYPAD are used to set field bus address and configuration of the process data channel (operating mode).



For connecting the communication module CM-DPV1 as well as the commissioning and diagnose of a drive controller in the PROFIBUS network, the user manual CM-DPV1 is required.

PROFIBUS configuration parameters

DRIVEMANAGER	Function	Value range	WE	Parameter
Address PROFIBUS	Set the software field bus address. The software address is only evaluated, if the coding switches S1 and S2 for the hardware address are set to 0.	0 ... 127	0	582_PPADR (_OPT)
Process data channel - configuration	Determination of the EASYDRIVE operating modes with definition of the control and status channel (see Table 6.42). The process data channel is preset when selecting a preset solution.	0 ... 255	0	589_OPCFG (_OPT)

Process data channel - configuration 589-OPCFG	
Setting	Mode of operation
0 - 3	-
4	EASYDRIVE Basic
5	EASYDRIVE ProgPos (PLC control)

Table 6.42 Setting the PROFIBUS process data channel

Process data channel - configuration 589-OPCFG	
Setting	Mode of operation
6	EASYDRIVE TablePos (travel set table)
7	EASYDRIVE DirectPos
8	-

Table 6.42 *Setting the PROFIBUS process data channel*

Explanations

- A diagnose of the PROFIBUS control and status word takes place with plugged on and active PROFIBUS module CM-DPV1 in the function menu "Actual values", tab "Option", see chapter 6.8.3.

6.6 Cam controller

Function	Effect
<ul style="list-style-type: none"> • Electronic cam controller with up to 16 cams • Can be used with positioning or speed control 	<ul style="list-style-type: none"> • Replacement for mechanical cam controllers • Short set-up time by changing cams • Selection of important settings for the application

The cam controller implemented in the positioning controller can most simply be described as a cylinder with radially attached cams along the axis of the cylinder. Up to 16 cams with start and end position, related to the cylinder diameter (cycle), can be arranged in any order. Each cam has an action register assigned, which triggers the corresponding actions when the cam is reached. This status can be reported to a superordinate controls, e. g. by setting a flag CMx. The flag status CMx can be transmitted via outputs or the field bus. The cam status can be additionally used by describing a PLC-flag in the sequencing control.

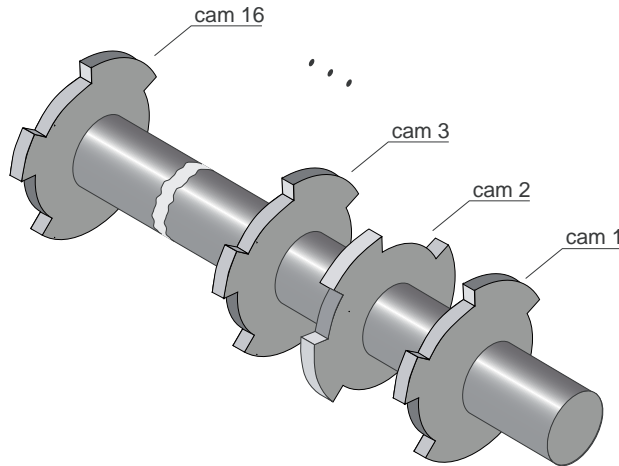

Fig. 6.52 Function of electronic cam controller

The cam controller is started and works if a cam number unequal zero is specified.



Cam settings

2.

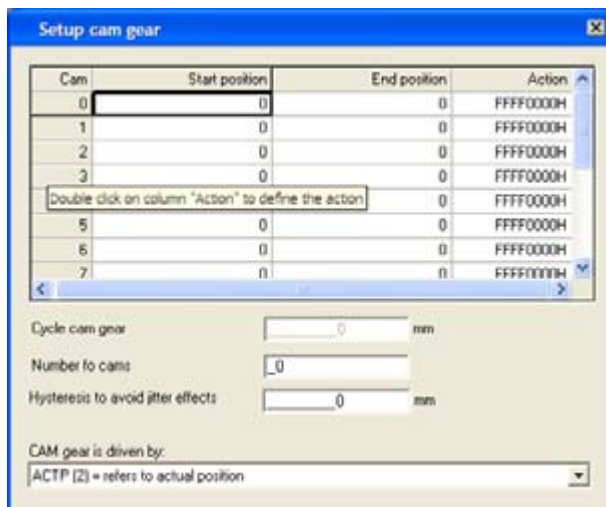

Pressing the button "Help" in the windows "Settings cam controller" and "Define action" opens the online help.

The corresponding configurations of the cam controller must be made with the following parameters:

DRIVEMANAGER	Meaning	Value range	WE	Parameter
Start position	The cam positions can be specified in any sequence, however, should always be inside the cycle, This condition is not checked!	0 ... 2147483647	0	743.x_CST AP (_CAM)
End position	Unit: Increments (65536/motor revolution) with speed control, user defined with positioning	0 ... 2147483647	0	744.x_CEN DP (_CAM)
Action	Setting switching points, setting PLC markers. Double-clicking on the column opens the action window. The parameter is bit coded acc. to Table 6.43.	00000000H ... FFFFFFFFH	FFFF0 000H	745.x_CAC TN (_CAM)

DRIVEMANAGER	Meaning	Value range	WE	Parameter
Cam controller cycle	<p>After the end of the defined cycle (revolution of the cam controller) the cycle is restarted.</p> <p>Permitted only with reference position CCENC = ENCD, EGEAR. With CCENC = ACTP the cycle depends on the actual position of the positioning controller (e.g. with endless positioning: Cycle = length of revolution).</p> <p>Unit: Increments (65536/motor revolution) with speed control, user defined with positioning</p>	0 ... 2147483647	0	741_CCCY C (_IN)
Number of cams	<p>Only the defined number of cams is evaluated. If the defined number of cams is zero, the cam controller will not be processed.</p>	0 ... 15	0	742_CCNUM M (_IN)
Hysteresis for avoidance of jitter effects	<p>It makes sense to select a bigger cam length than the hysteresis.</p> <p>Unit: Increments (65536/motor revolution) with speed control, user defined with positioning.</p>	0 ... 2147483647	0	747_CCHYS S (_IN)
Reference position	<p>Here the position source to feed the cam controller is set. The following settings are possible:</p> <p>"ENCD [0] = cam controller cycle related to the position encoder" := The cycle of the cam controller is determined by the current position of the position encoder.</p> <p>"EGEAR [1] = cam controller cycle related to the reference encoder" := The cycle of the cam controller is determined by the external reference encoder.</p> <p>"ACTP [2] = related to the actual position" := The cam controller cycle is determined by the actual position of the positioning controller.</p>	ENCD ... ACTP	ACTP	740_CCENC C (_CAM)

Defining the cam action



The following window opens when double-clicking into the column "Action":

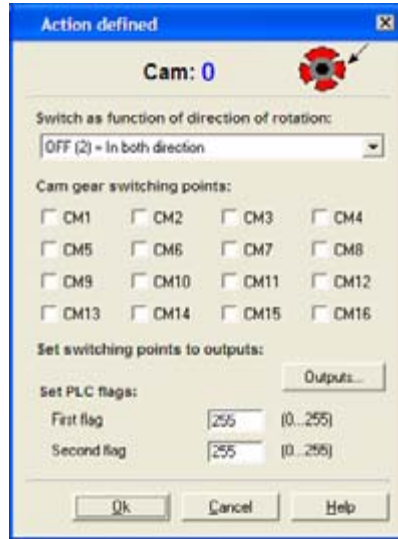

DRIVEMANAGER	Meaning	Value range	WE	Parameter
Sense of rotation dependent switching	Activation of cam only with defined travel direction. The following settings are possible: "NEG [0] = Only to negative direction" := The cam switches only in negative sense of rotation. "POS [1] = Only to positive direction" := The cam switches only in positive sense of rotation. "OFF [2] = To both directions" := The cam switches irrespective of the sense of rotation.	NEG ... OFF	OFF	750.x_CCDIR (_CAM)

The following actions (can also be multiply combined) are possible for each cam:

Bit	Default	Cam action
0	Inactive	Set/delete switch point CM1
1	Inactive	Set/delete switch point CM2
2	Inactive	Set/delete switch point CM3
3	Inactive	Set/delete switch point CM4
4	Inactive	Set/delete switch point CM5
5	Inactive	Set/delete switch point CM6
6	Inactive	Set/delete switch point CM7

Table 6.43 Action register for the individual cams 745.x_CACTN

Bit	Default	Cam action
7	Inactive	Set/delete switch point CM8
8	Inactive	Set/delete switch point CM9
9	Inactive	Set/delete switch point CM10
10	Inactive	Set/delete switch point CM11
11	Inactive	Set/delete switch point CM12
12	Inactive	Set/delete switch point CM13
13	Inactive	Set/delete switch point CM14
14	Inactive	Set/delete switch point CM15
15	Inactive	Set/delete switch point CM16
16 ... 23	255	Number of PLC-flag (00h - FFh)
24 ... 31	255	Number of PLC-flag (00h - FFh)

Table 6.43 Action register for the individual cams 745.x_CACTN



In order to avoid undefined conditions a flag (CMx or PLC-flag) must only be used in a cam or action register.

The switch points can be set to outputs. For this purpose the chosen output must be assigned to the cam controller (e.g.: OS02 := CM4 (46)). The assignment of the output takes place in the "Output" mask (button "Outputs").

Explanations

- Hysteresis

An hysteresis can be specified as a measure to avoid jitter effects. When the cam is reached the first time, the entry position is saved. If the cam is e.g. left at the same position, the cam condition will only

be deactivated when the hysteresis (747-CCHYS) has also been left. For a clear detection of the cam, the cam length must be adapted to the max. speed of the drive (detection in 1ms-cycle).

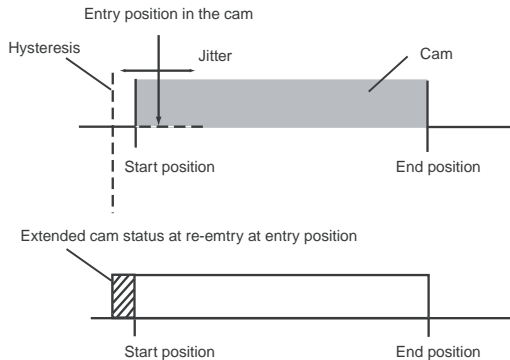

Fig. 6.53 Hysteresis with cam controller

- Synchronization of the cam controller
 - Synchronization of the cam controller to the current position via PLCMotion:

A positive flank of the flag M75 synchronizes the cam controller to the current position.
 - Synchronization of the cam controller to the current position via terminal:

A positive flank at the input parameterized to start "CAMRS (34 = reset cycle of cam controller)", synchronizes the cam controller to the current position.
- Stopping the cam controller

The cam controller is stopped by the sequencing program of the PLC or by the field bus. If the number of cams (parameter "742-CCNUM number of cams") is set to zero, the cam controller is stopped.
- Transmission of CAN-telegrams

The cam controller itself does not transmit any CAN-telegrams. Setting the markers 98 or 99, the virtual outputs OV00 und OV01, creates an event handling to CAN (see chapter 6.5.1, "TxPDO-Event control").

6.7 Setting KP200-XL

Function	Effect
<ul style="list-style-type: none"> • Determination of the permanent displays • Compilation of the user defined parameter subject area _11UA • Definition of additional actual values in the VAL menu 	<ul style="list-style-type: none"> • Selection of important actual values for permanent display • Selection of important settings for the application

User defined parameter subject area _11UA

- The user defined subject area _11UA is only visible in the PARA menu of the operation panel KEYPAD KP200-XL.
- The parameter 13-UAPSP is underlain by a data field, suitable for the input of max. 14 parameter numbers for display in the subject area _11UA.
- In the parameter subject area no actual value parameters can be displayed.
- All parameters displayed in this subject area can be edited in operation level 1.

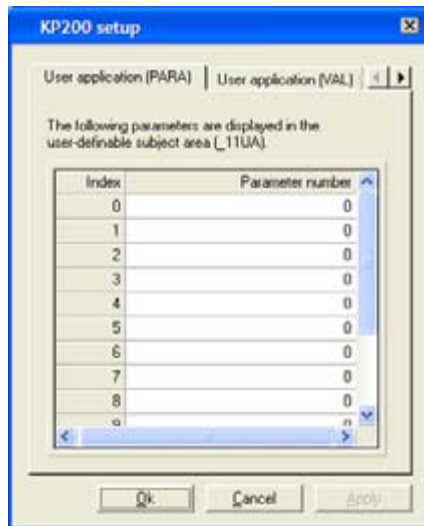

Fig. 6.54 Configuration of the user defined parameter subject area

DRIVEMANAGER	Value range	WE	Parameter
User application (PARA) for user defined parameter subject area	0 ... 999	0	13.x_UAPSP.x (_KPAD)

User defined actual value display

- User defined actual values are only visible in the VAL-menu of the KEYPAD operation panel KP200-XL.
- The parameter 12-UAVAL is underlain by a data field, suitable for the input of max. 14 parameter numbers for display in the VAL-menu.
- Editable parameters can also be displayed.
- All parameters entered here are also visible in operation level 1.

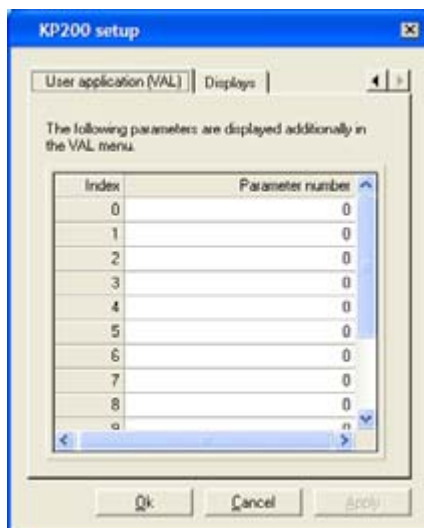

Fig. 6.55 Configuration of user defined actual values in the VAL-menu

DRIVEMANAGER	Value range	WE	Parameter
User application (VAL) for user defined actual value display	0 ... 999	0	12.x_UAVAL.x (_KPAD)

Display for permanent display of actual values and bar graph

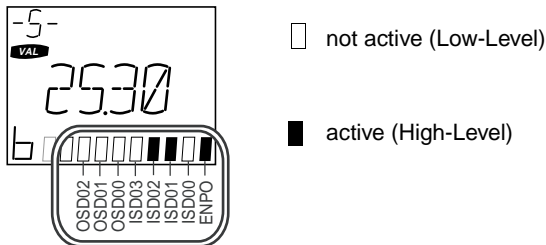

Fig. 6.56 Display for permanent display of actual values and bar graph

Permanent actual value display and bar graph can be used separately for the display of actual values. The bar graph is used for the status display of system values or to show the trend of individual actual values. The permanent actual value display is directly opened when accessing the VAL-menu (menu of actual values). The input of an index is only necessary for field parameters, i.e. a parameter with several entries. For all other parameters it must be set to 0.

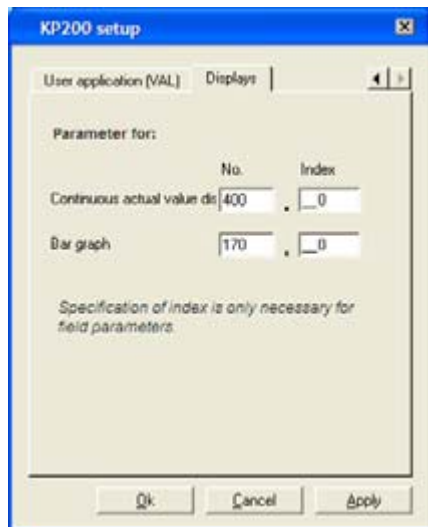

Fig. 6.57 Configuration of the permanent actual value and bar graph display

Adjustment possibilities for
360-DISP and 361-BARG

DRIVEMANAGER	Value range	WE	Parameter
Permanent actual value display No. / Index	1 ... 999 / 0 ... 255	400 / 0	360_DISP / 375_DPIDX (_KPAD)
Bar graph No. / Index	1 ... 999 / 0 ... 255	170 /	361_BARG / 374_BGIDX (_KPAD)

Function	Parameter		Operation level KP200	DISP	BARG
	DM	KP200			
Actual torque value	14	ACTT	2	✓	✓
Actual speed value	77	SPEED	2	✓	✓
d.c. link direct voltage	405	DCV	2	✓	✓
Current actual value of control	400	ACTV	2	✓	
Current setpoint of control	406	REFV	2	✓	✓
Effective value of apparent current	408	APCUR	2	✓	✓
System time after switching on	86	TSYS	3	✓	
Operating hours of positioning controller	87	TOP	3	✓	
States of digital inputs and outputs	419	IOSTA	2	✓	✓
Filtered input voltage ISA00	416	ISA0	4	✓	
Filtered input voltage ISA01	417	ISA1	4	✓	
Filtered input current ISA00	418	IISA0	4	✓	
Motor temperature with KTY84-evaluation	407	MTEMP	2	✓	
Internal temperature	425	DTEMP	2	✓	✓
Heat sink temperature	427	KTEMP	2	✓	✓
Filtered output voltage	420	OSA00	4	✓	

Table 6.44 Settings for permanent actual value and bar graph display

Standardization of parameters
with bar graph display

Parameter	Function	Effect/notes	Reference value
SPEED	current actual speed	only clockwise rotation (only positive values)	max. speed
APCUR	actual apparent current		2 ^{*N}

Table 6.45 Standardization of actual parameter values

Parameter	Function	Effect/notes	Reference value
ISA0	Voltage or current at analog input ISA00		10 V / 20 mA
ISA1	Voltage at analog input ISA01		10 V
MTEMP	actual motor temperature	Motor temperature only with linear evaluation (KTY)	200 °C
KTEMP	actual heat sink temperature	<p>≤ 15 kW: Temperatures > 100 °C in the output stage module correspond with temperatures > 85 °C on the heat sink and causes shut-down</p> <p>≥ 15 kW: Temperatures >85 °C cause shut-down, because the temperature sensor is directly mounted to the heat sink</p>	200 °C
DTEMP	actual inside temperature	Inside temperatures > 85 °C cause shut-down	200 °C
DCV	d.c. link direct voltage	Reference values depend on device design CDX32.xxx 500 V CDX34.xxx 1000 V	500 V / 1000 V
ACTT	current actual torque		max. torque

Table 6.45 Standardization of actual parameter values

6.8 Actual values



6.8.1 Temperature monitoring



Function	Effect
----------	--------

- Visualization of device and motor temperatures



Fig. 6.58 Actual temperature display

DRIVEMANAGER	Meaning	Unit	Parameter
Heat sink	Heat sink temperature of positioning controllers	°C	427-KTEMP (_VAL)
Inside	Inside temperature of positioning controllers	°C	425-DTEMP (_VAL)
Motor	<p>Motor temperature is only displayed if the motor is equipped with a linear temperature sensor KTY84-130 and the evaluation is parameterized, see chapter 6.4.3.</p> <ul style="list-style-type: none"> • The warning threshold can be programmed (see chapter 6.9.2) • If a temperature of 150°C is exceeded, a parameterizable error message will be displayed (see chapter 6.9.1) 	°C	407-MTEMP (_VAL)

Table 6.46 Temperature parameters

6.8.2 Device data

Function	Effect
<ul style="list-style-type: none"> Provision of all positioning controller data 	<ul style="list-style-type: none"> Clear identification of positioning controller and device software

The equipment data provide information about hardware and software, which should always be at hand when calling the support hotline.

The device data can partly also be read off the type plates.



Fig. 6.59 Tab "Device data"

DRIVEMANAGER	Meaning	Value range	Unit	Parameter
Software version	Software revision	*		92-REV (_STAT)
Software version - appendix -xx	Revision index as appendix to the revision number	*		106-CRIDX (_STAT)
CS:	Check sum XOR	*		115-CSXOR (_STAT)
Serial number	Serial number of the device	*		127-S_NR (_STAT)
Data set designation	Data set designation	0-28 characters		89-NAMDS (_CONF)
d.c. link direct voltage	Current d.c.link direct voltage	*	V	405-DCV (_VAL)

Table 6.47 Parameter Device data

6.8.3 Options

DRIVEMANAGER	Meaning	Value range	Unit	Parameter
Operating hours		*	h	87-TOP (_VAL)
Time after switching on		1 ... 65535	min	86-TSYS (_VAL)
*) With an actual value the value range is of no importance				

Table 6.47 Parameter Device data

Function	Effect
<ul style="list-style-type: none"> Provision of all data for a connected optional module 	<ul style="list-style-type: none"> Clear identification of the connected optional module Status display

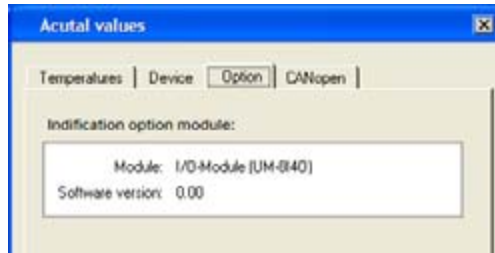

Fig. 6.60 Optional module status display, in this case the I/O-module UM-8140

The following modules can be used:

- PROFIBUS field bus module CM-DPV1
- Communication module UM-8140



Detailed information on optional modules can be found in the user manual (e. g. PROFIBUS user manual) or in the installation instructions.

The data of the optional module are displayed first. These consists of the detected module and, if present, of the software version of the module.

DRIVEMANAGER	Meaning	Parameter
Module	Identification of a connected module. Possible displays are: NONE: no module connected PROFI: PROFIBUS communication module CM-DPV1 IO1: I/O terminal extension module UM-8I40	579-OPTN1 (_OPT)
Software version	Software version of the connected optional module A value of 0.00 indicates that the module has no software.	576-OP1RV (_OPT)

Table 6.48 Parameters of the optional module identification

The rest of the display depends on the respective module.

Besides the option detection, the control and status word transmitted via field bus is also displayed when using PROFIBUS communication.

Status display for the PROFIBUS module CM-DPV1



Fig. 6.61 Status display for the PROFIBUS module CM-DPV1

DRIVEMANAGER	Function	Parameter
Process data channel - configuration	Active EASYDRIVE operation mode. Selection from menu "Bus systems/PROFIBUS", see chapter 6.5.2	589_OPFCFG (_OPT)
Control word PZD1-6	Display of the hexadecimal coded EASYDRIVE- control word with the PZD's 1-6. By clicking on the corresponding PZD, it is displayed bit coded, partly with text display, see Fig. 6.62.	589.x_PBCTR.x (_OPT)
Control word PZD1-6	Display of the hexadecimal coded EASYDRIVE- status word with the PZD's 1-6. By clicking on the corresponding PZD, it is displayed bit coded, partly with text display, see Fig. 6.62	599.x_PBSTA.x (_OPT)

Table 6.49 Parameters of the PROFIBUS module CM_DPV1 status display

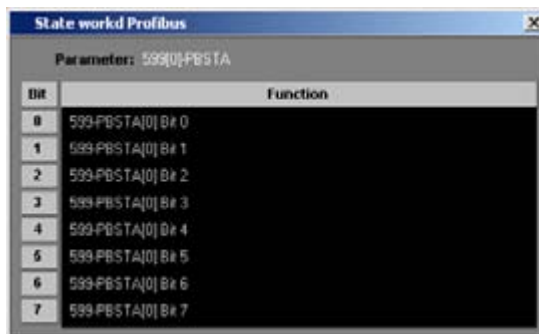

Fig. 6.62 Bit coded PZD-display

Explanations

- A detailed diagnose of the bus system is only possible with commercial bus analysers. Here only the control and status information can be checked.



For further information on PROFIBUS communication please refer to the CM-DPV1 user manual.

6.8.4 CAN_{open} Field bus

Function	Effect
<ul style="list-style-type: none"> Provision of the CAN_{open} communication status 	<ul style="list-style-type: none"> Clear identification of the correct data transfer



Fig. 6.63 CAN_{open} communication status

DRIVEMANAGER	Meaning	Parameter
Device address (partly not displayed in the function mask)	Device address, resulting from the sum of hardware coding and software setting (580-COADR).	571-CAADR (_CAN)
Active operation mode	Active (selected) CAN _{open} operation mode	653-H6061 (_CAN)
Network status	Current network status	588-NMT (_CAN)
Control word (byte1-0)	Hexadecimal coded control word for CANopen communication	573-H6040 (_CAN)
Extended control word (Byte 3-2)	Extended hexadecimal coded control word for CANopen communication with EASYDRIVE operation mode.	574-H223E (_CAN)

Table 6.50 Parameter CANopen field bus status

DRIVEMANAGER	Meaning	Parameter
Status word (byte1-0)	Hexadecimal coded status word for CANopen communication	572-H6041 (_CAN)
Extended status word (Byte 3-2)	Extended hexadecimal coded status word for CANopen communication with EASYDRIVE operation mode.	575-H223F (_CAN)

By clicking on the corresponding control or status word, it is displayed bit coded, partly with text display, see Fig. 6.62.

Table 6.50 Parameter CANopen field bus status

Explanations

- A detailed diagnose of the bus system is only possible with commercial bus analysers. Here only the control and status information can be checked.



For further information on CANopen communication please refer to the CANopen user manual.

6.9 Warnings/ errors

1.

6.9.1 Error messages



Function

- Display and resetting of drive system faults
- Setting of fault reactions

Effect

- Quick identification of fault cause and determination of the reaction of the drive to a fault

2.

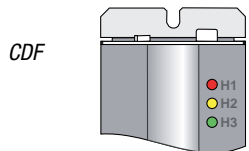
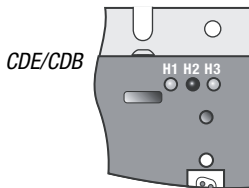

Fig. 6.64 Tab "Warnings/errors"

Error messages

Error messages can be detected and evaluated via the status LEDs of the controllers and the DRIVEMANAGER. A red flashing LED H1 indicates a fault.

The reaction to a fault can be parameterized in dependence on the cause of the fault.



Flash code of red LED (H1)	Display KeyPAD	Cause of fault
1x	E-CPU, various	Collective error message
2x	E-OFF	Undervoltage cut-off
3x	E-OC	Overcurrent cut-off
4x	E-OV	Overvoltage cut-off

Table 6.51 Error message signal

Flash code of red LED (H1)	Display KEYPAD	Cause of fault
5x	E-OLM	Motor overloaded
6x	E-OLI	Device overloaded
7x	E-OTM	Motor temperature too high
8x	E-OTI	Heat sink/device temperature too high

Table 6.51 Error message signal



Note: Further error numbers and possible causes can be found in the appendix.

Representation of the error history

The last four errors are stored in the history. Each error is saved with an error location number and the error time related to the operating hour meter.

After each error the error log rotates one step further and the error parameter will indicate the last fault.

View of the error history in the DRIVEMANAGER

The error history is displayed in the function mask "Error/Warning". When pressing button "Diagnose" the error cause is described in detail and remedial measures are suggested.

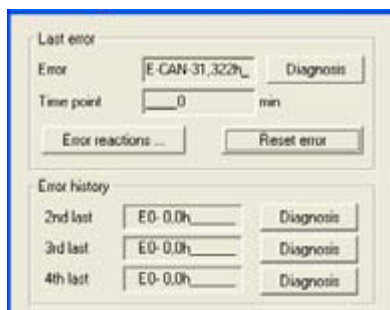
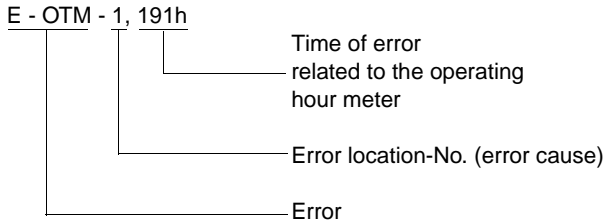

Fig. 6.65 Representation of the error history in the DRIVEMANAGER



DRIVEMANAGER	Meaning	Value range	WE	Unit	Parameter
Last error-Error	Last error	0 ... 65535	0	h	95-ERR1 (_ERR)
Last error-time	System time at occurrence of last error	0 ... 65535	0	min	94-TERR (_ERR)
Error history 2.-last	second last error	0 ... 65535	0	h	96-ERR2 (_ERR)
Error history 3.-last	third last error	0 ... 65535	0	h	97-ERR3 (_ERR)
Error history 4.-last	fourth last error	0 ... 65535	0	h	98-ERR4 (_ERR)

Table 6.52 Parameters of the error history

Error display with KEYPAD

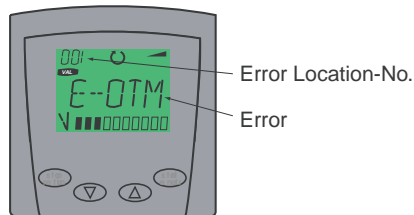

Fig. 6.66 Error display with KEYPAD



Note: A list of errors and warning messages displayed in the DRIVEMANAGER or KEYPAD can be found in the appendix.

resetting error

Error reactions ...

3.

Acknowledgement and resetting of errors

Errors can be acknowledged and reset in different ways:

- Rising flank at digital input ENPO
- Rising flank at a programmable digital input with setting of the function selector to RSERR
- Writing the first value to parameter 74-ERES via bus system or via corresponding bit in control word
- In DRIVEMANAGER under tab "Error/warnings" by pressing button "Reset error"
- In PLC-sequential program with command "SET ERRQ=1"

Errors and the related error reactions

Errors trigger different reactions. These can be set for any error.

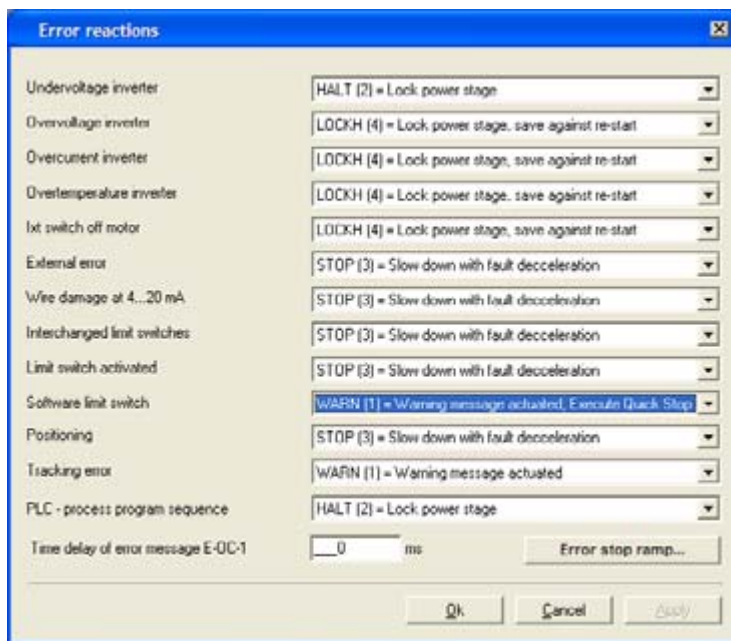

Fig. 6.67 Setting of fault reactions

DRIVEMANAGER	Value range	WE	Parameter
Converter undervoltage	HALT, LOCKH, RESET	HALT	512_R-OFF (_ERR)
Converter overvoltage	HALT, LOCKH, RESET	LOCKH	514_R-OV (_ERR)
Converter overcurrent	HALT, LOCKH, RESET	LOCKH	513_R-OC (_ERR)
Motor overtemperature	HALT ... RESET	LOCKH	516_R-OTM (_ERR)
lxl-motor cut-off	HALT ... RESET	LOCKH	519_R-OLM (_ERR)
External error message	WARN ... RESET	STOP	524_R-EXT (_ERR)
Wire breakage at 4 .. 20 mA	WARN ... RESET	STOP	529_R-WBK (_ERR)
Mixed up limit switches	HALT ... RESET	STOP	535_R-LSX (_ERR)
Limit switch contacted	HALT ... RESET	STOP	534_R-LS (_ERR)
Software limit switch	NOERR ... LOCKS	WARN	543_R-SWL (_ERR)
Positioning	HALT ... RESET	STOP	536_R-POS (_ERR)
Servo lag	WARN ... RESET	WARN	542_R-FLW (_ERR)
PLC-sequential program	WARN ... RESET	HALT	541_R-PLC (_ERR)
Time delay error message E-OC-1	0 ... 1000	0 ms	545_TEOC (_ERR)

Table 6.53 Parameters for error reactions in case of error messages

Explanations

- The functionality of the error reaction is described in Table 6.54.
- When switching in the motor line at the motor output to the positioning controller short-term high voltage peaks and currents will occur when the output stage is active or the motor is still excited. These will certainly not destroy the output stage of the positioning controller, but will occasionally cause E-OC-1 error messages. The output stage is already deactivated with message E-OC-1 when the overcurrent is detected. With the programmable time delay TEOC the error message is held back and after this time has expired the system will check whether the hardware release ENPO is still set. In this case the error message is signaled.
- The error stop ramp can be parameterized in a separate tab, see see chapter 6.2.3.

BUS	KP/DM	Function
0	NOERR	no reaction
1	WARN	Trigger warning (message), no further reaction concerning the drive. This warning is not of the same significance as the warning messages in chapter 6.9.2. NOTE: In contrast to the general definition, the error reaction "Software limit switch" causes a quick stop.
2	HALT	Lock output stage. If the error is no longer present, the device may be restarted after acknowledging the error message. With programmed auto start (7-AUTO=ON) the device starts automatically after the reset.
3	STOP	Brake drive with error stop ramp to 0 rpm, then block the output stage. If the error is no longer present, the device may be restarted after acknowledging the error message. With programmed auto start (7-AUTO=ON) the device starts automatically after the reset.
4	LOCKH	Block output stage and lock against restarting. If the error is no longer present, the device may be restarted after confirming the error message. With programmed auto start (7-AUTO=ON) automatic starting of the device is prevented.
5	LOCKS	Brake drive with error stop ramp to 0 rpm, then block the output stage. Secure against restarting. If the error is no longer present, the device may be restarted after acknowledging the error message. With programmed auto start (7-AUTO=ON) automatic starting of the device is prevented.

Table 6.54 Meaning of error reactions

BUS	KP/DM	Function
6	RESET	Lock output stages and wait for error reset by mains off/on.
		<p data-bbox="510 227 1116 254">Note: This error can only be reset by switching the mains supply</p> <div data-bbox="510 258 580 324" style="border: 1px solid black; padding: 2px; display: inline-block; text-align: center;">  </div> <p data-bbox="510 329 1116 355">off and on again!</p> <p data-bbox="510 394 1116 602">After a reset the device performs an initialisation and self-test phase. During this time the bus connection is interrupted and signal changes at the inputs are not detected. The outputs additionally take on their hardware rest position. The completion of an initialisation and self test phase can be displayed via a digital output as "Device operable". If the error is no longer present and the device reports to be operable after the reset, the device can be restarted. With programmed auto start (7-AUTO=ON) the device starts automatically.</p>

Table 6.54 *Meaning of error reactions*

6.9.2 Warning messages



Function	Effect
<ul style="list-style-type: none"> A warning is submitted when adjustable limits for various actual values of the positioning controllers or the motor are exceeded. 	<ul style="list-style-type: none"> EA forthcoming fault in the drive system will be signaled to the system at an early stage.



Fig. 6.68 Display of warnings in the tab "Warnings/errors"

Warning messages are automatically reset as soon as the reason for the warning no longer exists. They are reported or evaluated via:

- Digital outputs
- Field bus status word
- PLC-sequential program
- DRIVEMANAGER status display

The warning messages are displayed in the DRIVEMANAGER in parameter 122-WRN according to Table 6.55 hexadecimal coded.

Warning	Function	Hex-value	Bit
WOTI	Warning message, if the heat sink temperature exceeds the value specified in parameter 500-WLTI.	0001H	0
WOTD	Warning message, if the heat sink temperature exceeds the value specified in parameter 501-WLTD.	0002H	1
WOTM	Warning message, if the motor temperature has exceeded the value specified in parameter 502-WLTM.	0004H	2
WOV	Warning message, if the voltage in the d.c. link exceeds the value specified in parameter 504-WLOV.	0008H	3
WUV	Warning message, if the voltage in the d.c. link falls short of the value specified in parameter 503-WLUV.	0010H	4

Table 6.55 Hexadecimal representation of warning messages

Warning	Function	Hex-value	Bit
WLS	Warning message, if the output speed exceeds the value specified in parameter 505-WLS.	0020H	5
WIS	Warning message, if the apparent current has exceeded the value specified in parameter 506-WLIS.	0040H	6
WIIT	Warning message, if the I ² *t integrator of the device is active.	0080H	7
-	reserved	0100H	8
WIT	Warning message, if the Ixt-integrator of the motor is active.	0200H	9
WLTQ	Warning message, if the torque exceeds the value specified in parameter 507-WLTQ.	0400H	10

Table 6.55 Hexadecimal representation of warning messages

Warning messages come with a hysteresis:

Physical magnitude	Hysteresis
Voltages	Undervoltage - 0V / + 10 V Overvoltage - 10 V / + 10 V
Temperature	- 0 °C / + 5 °C
Frequency	+ 0 Hz / - 1 Hz

Table 6.56 Hysteresis for warning messages

Warning thresholds ...

Warning thresholds

Warning thresholds determine when a warning is to be submitted.



Fig. 6.69 Warning thresholds

DRIVEMANAGER	Value range	WE	Unit	Parameter
Heat sink temperature	5 ... 100	100	°C	500_WLTI (_WARN)
Internal temperature	5 ... 80	80	°C	501_WLTD (_WARN)
Motor temperature (only KTY84-130)	5 ... 250	180	°C	502_WLTM (_WARN)
Undervoltage	0 ... 800	0	V	503_WLUV (_WARN)
Motor protection (percentage of the maximum integrator value)	0 ... 100	0	%	337_WLITM (_WARN)
Overvoltage	0 ... 800	800	V	504_WLOV (_WARN)
Rotary speed	0 ... 32767	32767	rpm	505_WLS (_WARN)
Apparent current	0 ... 1000	1000	A	506_WLIS (_WARN)
Torque	-10000 ... 10000	10000	Nm	507_WLTQ (_WARN)
Switching-on delay (Option for the warning message "Torque")	0 ... 10	0	s	508_TWLTQ (_WARN)

Table 6.57 Parameter warning thresholds

Explanations

- Each warning can be emitted to any digital output.
- The motor temperature warning (WLTM) indicates an overloading of the motor.
- The device temperature warning (WLTi) takes the temperature value from the sensor mounted on the heat sink near the output stage transistors or, in case of small controllers, directly from the output stage module.
- Due to high break-away or starting torques it may be necessary to activate the torque warning threshold only if the threshold value is exceeded for a longer period of time. This can be accomplished with parameter 508-TWLTQ "Switch-on delay for torque warning threshold".
- Falling short of or exceeding the d.c. link direct voltage triggers the warning "Undervoltage" (WLUV) or "Overvoltage" (WLOV).
- The status word 122-WRN is made up of the existing warning messages. It is displayed in the window "Warnings/errors".

7 User programming

7.1	PLC functionality	7-3
7.2	PLC program	7-4
7.2.1	PLC editor	7-4
7.2.2	New programming	7-5
7.2.3	PLC program structure	7-5
7.2.4	Program testing and editing	7-7
7.2.5	PLC program files	7-7
7.2.6	Program handling	7-8
7.3	PLC command syntax	7-10
7.3.1	Overview	7-11
7.3.2	Detailed explanations	7-16
	Jump instructions sub-program invocations (JMP)	7-16
	Unconditional jump instructions	7-16
	Conditional jump instructions	7-16
	Actual value	7-16
	Setpoint	7-17
	Axis status	7-17
	Status of a digital input	7-17
	Status of a digital output	7-18
	Status of a logic marker	7-18
	Status of a special marker	7-18
	Value of an integer variable (direct comparison)	7-18
	Value of an integer variable (comparison with second variable)	7-18
	Value of a floating point variable (direct comparison)	7-18
	Value of a floating point variable (comparison with second variable)	7-19
	Status of a counter	7-19
	Status of a timer	7-19
	Sub-programs (CALL, RET)	7-20
	Setting a breakpoint (BRKPT)	7-20
	Blank instruction (NOP)	7-22
	Program end (END)	7-22
	Setting commands (SET)	7-23
	Setting a digital output	7-23
	Setting a logic marker	7-23
	Setting special markers – variables (status variables)	7-24

	Setting special markers – variables (control variables)	7-24
	Indexed assignment of a constant value	7-25
	Setting an integer variable	7-25
	Setting a special integer variable	7-28
	Setting a floating point variable	7-29
	Setting a special floating point variable	7-29
	Setting a counter	7-30
	Setting and starting a timer	7-30
	Setting parameters	7-30
	Setting field parameters	7-31
	Inverting (INV)	7-32
	Travel commands with positioning (GO)	7-32
	Travelling with or without continuation of program	7-32
	Travelling with continuation	7-33
	Travelling without continuation	7-33
	Referencing	7-34
	Travelling endless	7-34
	Speed synchronism	7-35
	Angular synchronism (electronic transmission)	7-35
	Path optimized positioning of a round table	7-37
	Braking the drive (STOP, SET HALT/BRAKE)	7-37
	Stop feed	7-37
	Quick stop	7-38
	Braking with deceleration ramp (only positioning)	7-38
	Braking with quick stop ramp (only positioning)	7-38
	Emergency stop (speed = 0) and shut-down of control (only positioning)	7-38
	Wait commands (WAIT)	7-39
	Time	7-39
	Axis status	7-39
	Parameter write access	7-39
	Example program	7-39
7.4	PLC control and parameters	7-41
7.4.1	PLC variables	7-42
7.4.2	PLC control parameters	7-43
7.5	PLC program examples	7-45
7.5.1	Conveyor belt	7-46
7.5.2	Absolute positioning	7-47
7.5.3	Relative positioning	7-49
7.5.4	Sequential program	7-50

7.1 PLC functionality

The PLC firmware contains a routine for the sequential processing of a user programmable sequential program.

Number of programs in the device memory:	1
Number of command lines per program:	254
Processing time per command line:	1 ...50 ms

The sequential program enables:

- Starting of the motor control
- Setpoint specification for motor control (torques, speeds, position)
- Setting/reading analog and digital outputs/inputs
- Reading/writing parameters
- Mathematical operations (+, -, *, :, ≠, £, ≥, modulo, abs, round)
- Logic operations (AND, OR, Exclusive OR)
- Time and counter functions
- Single axis positioning control

Work with the PLC functionality or the PLC editor requires an installed DRIVEMANAGER, because it is in integral part of this.

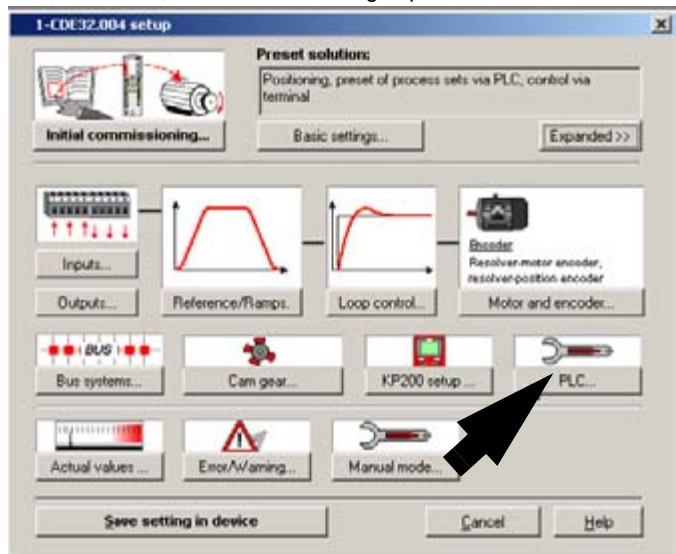

Fig. 7.1 DRIVEMANAGER main window

7.2 PLC program

The PLC editor is supplied as installation version on a separate CD-ROM. The languages German and English are available.

7.2.1 PLC editor

The PLC editor is an "Add-On" component of the DRIVEMANAGER and can thus only be used with the DRIVEMANAGER.

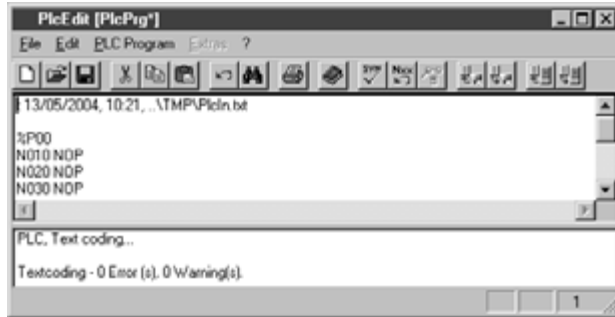
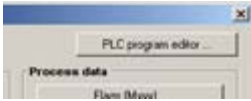

The PLC editor is only required for project planning or initial commissioning, series commissioning of the drive controller then takes place with the help of the DRIVEMANAGERdataset or the SMARTCARD.

The PLC program editor provides the functions:

- Program generation
 - Editor for program generation
 - Generation of a text declaration file <Project Name>.txt for the variables to display application specific texts in the DRIVEMANAGER.
 - Command code syntax check
 - Renumbering of line numbers
- Program handling
 - Loading/Saving/Printing/New generation of programs
 - Loading/Saving a program from/to the drive controller. Loading/Saving a program from/to DRIVEMANAGER dataset.
- Online help for PLC editor and command syntax with examples

All PLC functions can be selected via control buttons.

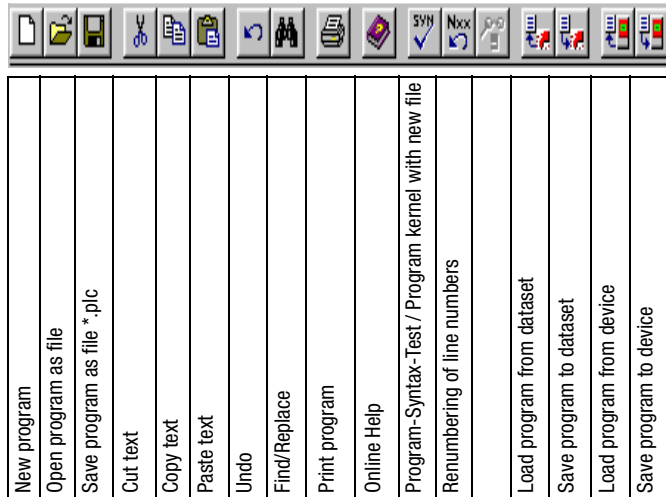

7.2.2 New generation of program

For a **quick start** or a **new generation** of a sequential program the syntax test is called up with an empty text field. The PLC editor now offers the generation of a program kernel.

7.2.3 PLC program structure

The PLC program editor supports the functions for program generation, program handling and online help for the PLC editor. These functions can be selected via control buttons, see chapter 7.2.1.

A program is divided into two parts:

1. Text declaration for variables, markers, counters and timers used
2. Sequential program

The **text declaration** serves the purpose of identifying the variables, markers, counters and timers used in the sequential program. The text declaration is used to generate a text file, which, after being evaluated in the DRIVEMANAGER, displays the values in the application specific texts.

The text declaration starts with a designator, which contains the project name of the text declaration file (for details please refer to "PLC program files").

```
%TEXT (Project name) ; Start of text declaration
```

This is followed by the assignment of parameter texts:



```

DEF M000 = Reference point_OK
DEF H000 = Setpoint position_1
DEF H001 = Setpoint position_2
DEF H002 = Actual position
DEF H003 = Zero offset
    
```

The end of the text declaration is always followed by the line:

```
END
```

The text declaration is optional. PLC parameters without declaration are not saved in the text file or are not displayed in the DRIVEMANAGER with their number.

Variable	Value
H000	360
H001	5000
H002	500
H003	0
H004	0
H005	0
H006	0
H007	0
H008	0
H009	0
H010	0

Flag	Value
M000	0
M001	0
M002	0
M003	0
M004	0
M005	0
M006	0
M007	0
M008	0
M009	0
M010	0

Fig. 7.2 Display of PLC values with application specific texts

The **Sequential program** follows the text declaration. It contains a program header, the actual program section and the program end.

The program header consists of a line with program number (at present only %P00 possible):

```
%P00
```

The lines of the actual program section are referred to as command lines. The maximum number of sets that can be saved in the positioning controller is limited to (N001 ... N254). Each command line consists of a line number, the command and the operand. After separation by means of a semicolon a comment can be inserted.

```
N030 SET M000 = 0;           Reference point not defined
```

The program end is always followed by the line (without line number):

```
END
```

Example programs can be found in the installed DRIVEMANAGER directory „..\userdata\samples\PLC“.

7.2.4 Program testing and editing

The **syntax test** checks the current program for errors in the command code. The test is automatically conducted when saving the program to the drive controller or, manually, by pressing the corresponding button. The result of this test is displayed in the status bar. In case of error messages one can jump directly to the faulty program line by simply double-clicking on the corresponding error message.

Renumbering the line numbers eases inserting program sets. With renumbering the first line is identified by number N010, all further lines are incremented with a step width of 10 (N020, N030, ...). If the representation of a program with the specified line range (001-254) is not possible this way, the step width will be automatically reduced.

7.2.5 PLC program files

The **program content** is saved in two files:

1. **Program file *.plc**

This file contains the sequential program as well as the text declaration, and therefore the complete program information. When passing on the PLC program it is thus enough to just copy this file.

2. **Text declaration file <Project name>.txt**

The file is used by the DRIVEMANAGER to display the application specific parameter designations.

It is automatically generated from the text declaration of the program file after successfully completed loading of the program into the drive controller or into a dataset. The file <Project name>.txt is copied into the DRIVEMANAGER directory "LUST

DriveManager\firmdata\<Projektname>.txt". This file is now available on the PC used to generate the program or to load the source code into the drive controller. However, it can also be copied to other PCs.



The complete sequential program is saved in two parameters as machine code. These parameters are contained in the device data set and can thus be loaded or saved via the DRIVEMANAGER or, in case of series commissioning, via the SMARTCARD.



For reproduction of all program information or data each program must be saved as *.plc file.

The comment lines in the sequential program and the text declarations are not saved in the controller or in the device dataset, i.e. they cannot be read back.

7.2.6 Program handling

Open / Edit

An existing PLC program can be opened in different ways:

1. Double-click on the file *.plc. This opens the DRIVEMANAGER, which in turn starts the PLC editor and opens the program.
2. Opening via the DRIVEMANAGER menu "File/Open/PLC Sequential Program ..."



Fig. 7.3 Opening a PLC program via DriveManager

3. Opening via the already started PLC editor



4. Opening of a program from a device dataset.



Saving after Create / Edit

An existing PLC program can be saved by the PLC editor in different ways.

1. Saving a program into a file

With this button a file *.plc is created on your PC; this file contains the PLC program and the text declaration.

2. Saving a program into a device

With this button the PLC program is saved as machine code into two parameters in the controller. The file <Project name.txt> generated from the text declaration is thus saved in the corresponding DRIVEMANAGER directory, see 7.2.5.

3. Saving a program into a dataset

With an existing device dataset this button can be used to save a PLC program into an existing device dataset. The file <Project name.txt> generated from the text declaration is thus saved in the corresponding DRIVEMANAGER directory, see 7.2.5.



Attention: It is not possible to generate a new dataset, which only contains the PLC program.

7.3 PLC command syntax

Operand	Comment
Cxx, Cyy	Counter index 00-10
Hxxx, Hyyy	Variable index 000-127
Fxxx, Fyyy	Variable index 000-127
Zxx, Zyy	Timer index 00-10
Ny	Line number 001-254
PARA[n, i]	Parameter number n 000-999 Parameter index i 000-255
Mxxx, Myyy	Flag index 000-255
Ippi	Inputs ppi = A00, A00, E00-E07, S00-S03 (CDB3000), S00-S06 (CDE3000), S00-S02 (CDF3000)
Oppi	Outputs ppi = E00-E03, S00-S02 (CDB3000), S00-S04 (CDE3000), S00, S03-S05 (CDF3000)

Operand	Comment
b	Value 1-32
d	Counter reading 0 ...65535 (16 bit)
t	Timer reading 0 ... 4.294.967.295 (32 bit)
f	Numerical floating point value (32 bit)
z	Integer numerical value ±2147483648 (32 bit)

Logic operands:

Operand	Comment
&	AND
	OR
^	Exclusive OR
!=	≠
<=	≤
>=	≥
ABS	Absolute-value generation

Mathematical operands:

Operand	Comment
+	Addition
-	Subtraction
*	Multiplication
:	Division
%	Modulo
ABS	Absolute-value generation
ROUND	Rounding

7.3.1 Overview

Command	Operand	Comment
Jump instructions		
JMP		Ny/END unconditional jump
	(ACTVAL = < > Hxxx,Fyyy)	Ny/END Actual value
	(ACTVAL <= >= Hxxx,Fyyy)	Ny/END
	(ACTVAL != Hxxx,Fyyy)	Ny/END
	(ACTVAL = != 0)	Ny/END
	(REFVAL = < > Hxxx,Fyyy)	Ny/END Setpoint
	(REFVAL <= >= Hxxx,Fyyy)	Ny/END
	(REFVAL != Hxxx,Fyyy)	Ny/END
	(REFVAL = != 0)	Ny/END
	(REF = 0/1, =Mxxx)	Ny/END Axis status setpoint reached
	(ROT_0 = 0/1, =Mxxx)	Ny/END Axis status standstill
	(Ippi = 0/1)	Ny/END Status of an input
	(Oppi = 0/1)	Ny/END Status of an output
	(Mxxx = 0/1, != Myyy)	Ny/END Status of a flag
	(spec. flag = 0/1, != Myyy)	Ny/END Status of a special flag, e. g. STA_REF
	(Mxxx & I ^ Ippi)	Ny/END Logic operation flag input
	(Mxxx & I ^ Oppi)	Ny/END Logic operation flag output
	(Hxxx = != 0)	Ny/END
	(Hxxx = != < <= > >= Hyyy)	Ny/END Value of integer variables
	Ny/END	
	(Fxxx = != 0.0)	Ny/END
	(Fxxx= != < <= > >= Fyyy)	Ny/END Value of floating point variables
	Ny/END	
	(Cxx = != d)	Ny/END Counter status
	(Zxx = != 0)	Ny/END Timer status
	END	Jump to program end
Sub-program invocation		
CALL	Ny	Sub-program invocation after line Ny Maximum nesting depth. 250
RET		Return to the line of sub-program invocation
BRKPT	SET BRKPT=1	Activates breakpoint; the set breakpoint is evaluated
	SET BRKPT=0	Deactivates breakpoint; the set breakpoint is not evaluated

Command	Operand	Comment
Setting commands		
SET	Opxx = 0/1, Mxxx	Output direct or with flag
	OUTPUT = Hxxx	Set output image
	Mxxx = 0/1, Ippi, Oppi, Myyy, M[Cxx]	Set flag
	Mxxx = Hxxx	Set flag (LSB of Hxxx)
	M[Cxx] = 0/1	
	M[Cxx] = Myyy	Set flag (indexed*)
	Mxxx & I ^ Myyy	Link flag logically
	Mxxx = STA_ERR	Read error status (1 -> error)
	Mxxx = STA_WRN	Read warning status (1 -> Warning)
	Mxxx = STA_ERR_WRN	Read warning/error status (1 -> Warning/Error)
	Mxxx = STA_ACTIV	Control active
	Mxxx = STA_ROT_R	Motor turning clockwise
	Mxxx = STA_ROT_L	Motor turning anti-clockwise
	Mxxx = STA_ROT_0	Motor standstill
	Mxxx = STA_LIMIT	Setpoint limitation
	Mxxx = STA_REF	Setpoint reached
	Mxxx = STA_HOMATD	Reference point defined
	Mxxx = STA_BRAKE	Quick stop active
	Mxxx = STA_OFF	Deenergized state
	Mxxx = STA_C_RDY	Control standby state
	Mxxx = STA_WUV	Undervoltage warning
	Mxxx = STA_WOV	Overvoltage warning
	Mxxx = STA_WIIT	Warning $I^2 \cdot t$
	Mxxx = STA_WOTM	Warning motor overtemperature
	Mxxx = STA_WOTI	Warning heat sink temperature
	Mxxx = STA_WOTD	Warning inside temperature
	Mxxx = STA_WIS	at present no function (always 1)
	Mxxx = STA_WFOUT	at present no function (always 1)
	Mxxx = STA_WFDIG	at present no function (always 1)
	Mxxx = STA_WIT	Warning $I \cdot t$ motor protection
	Mxxx = STA_WTQ	Warning torque
	Mxxx = STA_INPOS	Setpoint position reached
	ENCTRL = 0/1, Mxxx	Controller off / on
	INV = 0/1, Mxxx	Invert setpoint (only with speed and torque control)
	ERR = 1, Mxxx	Trigger error

Command	Operand	Comment
	ERRRQ = 1, Mxxx	Reset error
SET	BRKPT = 0/1, Mxxx	Breakpoints off / on
	BRAKE = 0/1, Mxxx	Quick stop off / on
	HALT = 0/1, Mxxx	Halt/Feed off / on
	PCTRL = 0/1, Mxxx	no function
	Hxxx = EGEARPOS, EGARSPEED	Read reference encoder increments, reference encoder speed
	F[CXX], H[Cxx], M[Cxx] = Value	Indexed assignment
	Hxxx = z, Hyyy, H[Cyy], Fxxx, Mxxx, Cyy, Zxx	Set variable
	H[Cxx] = z, Hyyy	Set integer variable (indexed*)
	Hxxx + - * : % z, Hyyy	Calculate variable
	Hxxx << >> z, Hyyy	Displace variable
	Hxxx = ABS Hyyy	Variable absolute-value generation
	Hxxx = PARA[n], PARA[n, i]	Set variable
	Hxxx, Fxxx = REFPOS	Position setpoint
	Hxxx, Fxxx = ACTPOS	Actual position value
	Hxxx, Fxxx = ACTFRQ	Assign actual frequency [Hz]
	Hxxx, Fxxx = ACTSPEED	Assign actual speed [min ⁻¹]
	Hxxx, Fxxx = ACTTORQUE	Assign actual torque [Nm]
	Hxxx, Fxxx = ACTCURRENT	Assign actual current (effective) [A]
	Hxxx = OSA0	Analog output value
	Hxxx = ISA0, ISA1	Assign analog input 0 / 1
	Hxxx = OUTPUT, INPUT	Read variable with output or input image
	EGEARPOS = Hxxx	Set reference encoder increments
	OSA0 = Hxxx	Assign analog value
	REFVAL = Hxxx, Fxxx	Assign setpoint (only with speed and torque control)
	INPOSWINDOW = Hxxx	Setpoint reaches window
	Fxxx = f, Hxxx, F[Cxx], Fyyy	Set floating point variable
	F[Cxx] = f, Fyyy	Set floating point variable (indexed)
	Fxxx + - * : f, Fyyy	Calculate floating point variable
	Fxxx = ROUND Fyyy	Round floating point variable
	Fxxx = ABS Fyyy	Floating point variable absolute-value generation
	Fxxx = PARA[n, i], PARA[n], PARA[Hyyy,Hzzz], PARA[Hyyy]	Set parameter
	Cxx = d, Cyy, Hyyy	Set counter
	Cxx + - d, Hyyy	Calculate counter
	Zxx = t, Hyyy	Set timer
	PARA[n] = Hxxx, Fxxx	Parameter number direct

Command	Operand	Comment
	PARA[Hxxx] = Hyyy, Fxxx	Parameter number via integer variable
SET	PARA[n,i] = Hxxx, Fxxx	Input parameter number, direct
	PARA[Hxxx, Hyyy] = Hzzz, Fxxx	Specification parameter number and index via integer variable
	ACCR = Hxxx	Change acceleration
	DECR = Hxxx	
	ACCR = 0 ...150%	Scaling
	DECR = 0 ...150%	Scaling
Wait commands		
WAIT	d, Hxxx	Wait time in ms (0 ... 4.294.967.295 ms)
	ROT_0	Setpoint position = target position
	REF	Actual position in position window
	PAR	Wait until parameter is written.
Travel commands (only with positioning)		
GO	W A Hxxx	Travel absolute by value of Hxxx with speed acc. to parameter 724_POSMX and wait with program processing, until target position is reached.
	W R Hxxx	Travel relative by value of Hxxx with speed acc. to parameter 724_POSMX and wait with program processing, until target position is reached.
	A Hxxx	Travel absolute by value of Hxxx with speed acc. to parameter 724_POSMX (program processing continues)
	R Hxxx	Travel relative by value of Hxxx with speed acc. to parameter 724_POSMX (program processing continues)
	0	perform selected referencing
	0+Hxxx	perform selected referencing and set reference position=Hxxx
	A Hxxx V Hyyy	Travel absolute by value of Hxxx with speed Hyyy (program processing continues)

Command	Operand	Comment
	R Hxxx V Hyyy	Travel relative by value of Hxxx with speed Hyyy (program processing continues)
GO	T[Hxxx]	Position via table
	T[Cxx]	Travel via table entry Cxx
	W T[Hxxx]	Travel via table entry Hxxx, wait
	W T[Cxx]	Travel via table entry Cxxx, wait
	T[xxx]	Travel via table entry xxx
	W T[xxx]	Travel via table entry xxx, wait until position is reached
	V Hxxx	Travel endless via variable
	W A Hxxx V Hyyy	Travel absolute by value of Hxxx with speed Hyyy and wait with program processing, until target position is reached
	W R Hxxx V Hyyy	Travel relative by value of Hxxx with speed Hyyy and wait with program processing, until target position is reached
	SYN 1 / SYN 0	Switching synchronous travel on and off
Command to stop the drive		
STOP	B	Braking with parameterized deceleration (only with positioning)
STOP	M	Braking with quick stop ramp (only with positioning)
STOP	0	Braking with quick stop ramp and shut-down of control, if control location=PLC (only with positioning)
SET	BRAKE = 0/1, Mxxx	Perform quick stop acc. to quick stop reaction (see 6.2.3): 1: Perform quick stop 0: End quick stop
SET	HALT = 0/1, Mxxx	Stop feed acc. to reaction (see 6.2.3): 1: Stop axis 0: Enable axis
Further commands		
NOP		Instruction without function
INV	Oppi, Mxxx, Hxxx	Inverting
END		Quits the program, all other lines will be ignored. Do not enter line number.

Command	Operand	Comment
BRKPT		Insert breakpoint into program line, evaluation with active breakpoints, see page 7-11

7.3.2 Detailed explanations



Unconditional jump instructions

Conditional jump instructions



Actual value

Jump instructions and sub-program invocation (JMP)

- Unconditional jump instructions will be executed in any case (without condition).
- Conditional jump instructions will only be executed when the specified condition is fulfilled. The condition for execution is specified in parenthesis (...).
- A line number or the end of the program is always specified as jump target.

Attention: If a JMP/SET command is set to non-existing inputs/outputs, no error message will be generated.

These commands are not linked to any prerequisites (axis position, status of programmed variables) and are thus executed directly and unconditionally.

```
JMP Ny      Jump to set with number y
JMP END     Jump to program end
```

Conditional jump instructions / sub-program invocations are linked with certain conditions, which are specified in parenthesis. If this condition is fulfilled, the jump to the specified set number or the end of the program will be executed. If the condition is not fulfilled, the program will continue with the next successive set.

Note: The execution of a conditional jump can be linked to one of the following conditions.

reached:

```
JMP (ACTVAL = Hyyy, Fyyy) Ny/END
```

exceeded:

```
JMP (ACTVAL > Hxxx, Fyyy) Ny/END
```

```
JMP (ACTVAL >= Hxxx, Fyyy) Ny/END
```

fallen short of:

```
JMP (ACTVAL < Hxxx, Fyyy) Ny/END
```

```
JMP (ACTVAL <= Hxxx, Fyyy) Ny/END
```

compare:

```
JMP (ACTVAL != Hxxx, Fyyy) Ny/END
```

```
JMP (ACTVAL = 0) Ny/END
```

```
JMP (ACTVAL != 0) Ny/END
```



Note: The command REFVAL is of relevance for the speed control. In case of positioning the command REF is processed, because this command refers to "Setpoint reached".

Setpoint

reached:

```
JMP (REFVAL = Hxxx, Fyyy) Ny/END
```

exceeded:

```
JMP (REFVAL > Hxxx, Fyyy) Ny/END
```

```
JMP (REFVAL >= Hxxx, Fyyy) Ny/END
```

fallen short of:

```
JMP (REFVAL < Hxxx, Fyyy) Ny/END
```

```
JMP (REFVAL <= Hxxx, Fyyy) Ny/END
```

compare:

```
JMP (REFVAL != Hxxx, Fyyy) Ny/END
```

```
JMP (REFVAL = 0) Ny/END
```

```
JMP (REFVAL != 0) Ny/END
```

Axis status

REF reached:

```
JMP (REF = 1) Ny/END Actual value in setpoint window
```

REF not reached:

```
JMP (REF = 0) Ny/END Actual value not in setpoint window
```

in dependence on a flag:

```
JMP (REF = Mxxx) Ny/END Flag: Mxxx=1; Mxxx=0
```

Axis stopped:

```
JMP (ROT_0 = 1) Ny/END
```

Axis moves:

```
JMP (ROT_0 = 0) Ny/END
```

in dependence on a flag:

```
JMP (ROT_0 = Mxxx) Ny/END
```

Status of a digital input

Status = 0:

```
JMP (Ippi = 0) Ny/END
```

Status = 1:

```
JMP (Ippi = 1) Ny/END
```

Status of a digital output

Status = 0:

JMP (Oppi = 0) Ny / END

Status = 1:

JMP (Oppi = 1) Ny / END

Status of a logic flag

JMP (Mxxx = Myyy) Ny / END
 JMP (Mxxx != Myyy) Ny / END
 JMP (Mxxx = 0) Ny / END
 JMP (Mxxx = 1) Ny / END
 JMP (Mxxx & Ippi) Ny / END
 JMP (Mxxx | Ippi) Ny / END
 JMP (Mxxx ^ Ippi) Ny / END
 JMP (Mxxx & Oppi) Ny / END
 JMP (Mxxx | Oppi) Ny / END
 JMP (Mxxx ^ Oppi) Ny / END

Status of a special flag

JMP (spec. flag = Mxxx) Ny / END
 JMP (spec. flag != Mxxx) Ny / END
 JMP (spec. flag = 0) Ny / END
 JMP (spec. flag = 1) Ny / END

Value of an integer variable (direct comparison)

compare:

JMP (Hxxx = 0) Ny / END
 JMP (Hxxx != 0) Ny / END

Value of an integer variable (comparison with second variable)

compare:

JMP (Hxxx = Hyyy) Ny / END
 JMP (Hxxx != Hyyy) Ny / END

exceeded:

JMP (Hxxx >= Hyyy) Ny / END
 JMP (Hxxx > Hyyy) Ny / END

fallen short of:

JMP (Hxxx <= Hyyy) Ny / END
 JMP (Hxxx < Hyyy) Ny / END

Value of a floating point variable (direct comparison)

compare:

JMP (Fxxx = 0.0) Ny / END
 JMP (Fxxx != 0.0) Ny / END



Value of a floating point variable (comparison with second variable)

compare:

```
JMP (Fxxx = Fyyy)      Ny / END
JMP (Fxxx != Fyyy)     Ny / END
```

exceeded:

```
JMP (Fxxx >= Fyyy)     Ny / END
JMP (Fxxx > Fyyy)      Ny / END
```

fallen short of:

```
JMP (Fxxx <= Fyyy)     Ny / END
JMP (Fxxx < Fyyy)      Ny / END
```

Status of a counter

```
JMP (Cxx = d)          Ny/END      Jump if value is reached
JMP (Cxx != d)         Ny/END      Jump if value is not reached
```

Status of a timer

```
JMP (Zxx = 0)          Ny/END      Timer run out?
JMP (Zxx != 0)         Ny/END      Timer not yet run out?
```



Note: A query for equality is only possible with a run-out timer (i.e. "= 0"), because it cannot be assured that a certain intermediate status ("=t") is reached at the time of the query.

Sub-programs (CALL, RET)

A sub-program is a part of the main program. No independent program header, e. g. P01, is generated. The invocation is not realized by means of JMP, but via CALL.

```
CALL Ny          Invocation of a sub-program, or a jump to
                  the first program line of the sub-program

RET             Return from the sub-program
```

Possible structure of the program
(the line numbers only serve as examples)

```
N010 ...          ; Start of main program
...
N050 CALL N110    ; Sub-program invocation
...
N100 JMP ...      ; End of main program

N110 ...          ; Start of sub-program
...
N200 RET          ; End of sub-program
```



After processing of the sub-program the program is continued with the set following the invocation (CALL). The maximum nesting depth for sub-programs is 250. If this number is exceeded an error message will be issued and the running program will be aborted.

Setting a breakpoint (BRKPT)

With this command the sequential program can be interrupted at any line.

How to use breakpoints in a sequential program:

Activating/deactivating breakpoints in the sequential program

```
Ny SET BRKPT = 1 / 0
```

Setting breakpoints in a line in the sequential program

```
Ny BRKPT
```

With activated breakpoints the program processing is interrupted in line Ny (parameter 450 PLCST = BRKPT).

By starting (parameter operation status on "Start" in the PLC window, 450-PLCST = GO) the program processing is continued with the next command line.



Note: Breakpoints can also be set via the user interface of the DRIVEMANAGER.

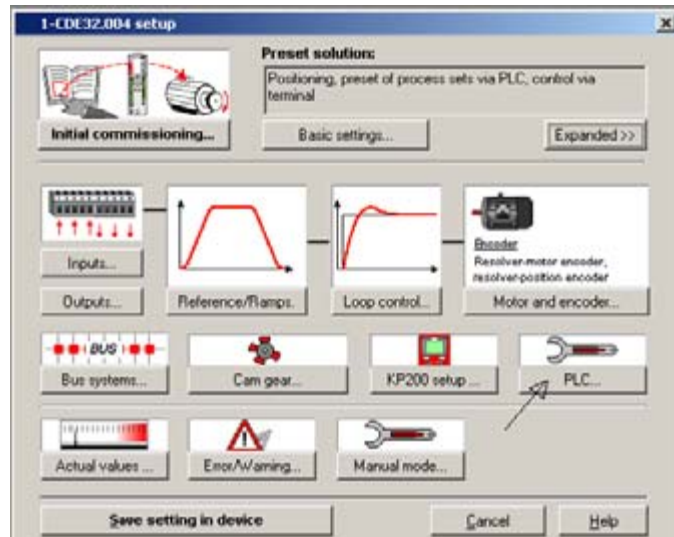

Switching off the PLC (e.g. via parameter 450 PLCST = OFF) the program processing is ended.

; Example program

```

%P00
N010  NOP                                ; no instruction
N020  SET BRKPT = 1                      ; activate breakpoints
N030  SET H000 = 0                       ; assign variable
N040  SET H001 = 10                      ; assign variable
N050  BRKPT                              ; breakpoint
N060  SET H000 + 1                       ; increment variable
N070  JMP (H000 < H001) N100            ; H000 smaller 10 ?
N080  SET BRKPT = 0                     ; deactivate breakpoints
N100  JMP N040                          ; continue incrementing
END
    
```

With deactivated breakpoints this function is similar to a blank instruction (NOP).

Blank instruction (NOP)

This is an instruction without function, i.e. the program processes the line, but no reaction will occur. The processing requires (as with other commands) computing time.

How to use this function in the sequential program:

```
Ny NOP Instruction without function
```

Program end (END)

Both the text declaration as well as the actual sequential program must be quit with this command. All subsequently following lines will be ignored. In case of a missing END an error message will be emitted.

How to use this function in the sequential program

```
END No line number is specified!
```

1

2

3

4

5

6

7

8

A

Setting commands (SET)



Note: The results of calculations etc. are always saved in the left variable.
 F001 = 10; F002 = 15, Set F001 - F002;
 "-5" is generated in F001

With the help of setting commands a vast variety of operations can be executed in the travel programs:

- Setting of outputs (direct, via flags)
- Setting of flags (direct, indexed, via logic operations, ...)
- Setting, calculation of variables, ...
- Setting, incrementing, decrementing of counters
- Setting and starting of timers
- Access to device parameters (e. g. controller settings, override functions, setpoint tables, etc.)
- Changing of acceleration parameters

Setting a digital output

direct:

```
SET Oppi = 0
SET Oppi = 1
```

via flag:

```
SET Oppi = Mxxx
```

Output image:

```
SET OUTPUT = Hxxx
```



Attention: Only the outputs will be set, which have their function selector FOppi=PLC set.

Setting logic flag

direct:

```
SET Mxxx = 0
SET Mxxx = 1
```

indexed:

```
SET M[Cxx] = 0
SET M[Cxx] = 1
```

via 2. flag:

direct:

```
SET Mxxx = Myyy      assign flag value
```

indexed:

```
SET M[Cxx] = Myyy
```

via logic operation:

```
SET    Mxxx & Myyy      Logic AND
SET    Mxxx | Myyy      Logic OR
SET    Mxxx ^ Myyy      Logic EXCLUSIVE-OR
```

via integer variable

```
SET Mxxx = Hxxx      Assignment of LSB for Hxxx
```

via digital inputs and outputs

```
SET Mxxx = Ippi      assign status input
SET Mxxx = Oppi      assign status output
```

Setting special markers – variables (status variables)

```
SET Mxxx = STA_ERR      Drive in error status
SET Mxxx = STA_WRN      Drive in warning status
SET Mxxx = STA_ERR_WRN  Drive in status error / warning
SET Mxxx = STA_ACTIV    Control active
SET Mxxx = STA_ROT_R    Motor rotating clockwise
SET Mxxx = STA_ROT_L    Motor rotating anti-clockwise
SET Mxxx = STA_ROT_0    Motor stopped
SET Mxxx = STA_LIMIT    Limit reached
SET Mxxx = STA_REF      Setpoint reached
SET Mxxx = STA_HOMATD   Axis referenced
SET Mxxx = STA_BRAKE    Drive in braking state
SET Mxxx = STA_OFF      Drive in de-energized state
SET Mxxx = STA_C_RDY    Drive in status "Controller ready"
SET Mxxx = STA_WUV      Warning undervoltage
SET Mxxx = STA_WOV      Warning overvoltage
SET Mxxx = STA_WIIT     Warning warning I^2*t
SET Mxxx = STA_WOTM     Warning motor overtemperature
SET Mxxx = STA_WOTI     Warning heat sink temperature
SET Mxxx = STA_WOTD     Warning inside temperature
SET Mxxx = STA_WIS      Warning apparent current - limit value
SET Mxxx = STA_WFOUT    Warning output frequency - limit value
SET Mxxx = STA_WFDIG    Warning setpoint master error
SET Mxxx = STA_WIT      Warning I*t motor protection
SET Mxxx = STA_WTQ      Warning torque
SET Mxxx = STA_INPOS    Position setpoint reached
                        (only with positioning controller
```

switched on)

Setting special flags – variables (control variables)

```
SET ENCTRL = 0 / 1, Mxxx Control off / on (only with control
location PLC)
SET INV = 0 / 1, Mxxx   Invert setpoint
                        (only with speed control, not with
                        endless positioning)
```

```

SET ERR    = 0 / 1, Mxxx  Trigger error
SET ERRRQ  = 0 / 1, Mxxx  Reset error
                                Attention: PLC must not be switched off
                                with controller. Observe the control
                                location when switching on via PLC!

SET BRKPT  = 0 / 1, Mxxx  Breakpoints off / on
SET ACCR   = 0 ... 150%   Scaling of acceleration from 0
                                percent to 150 percent
SET ACCR   = 0 ... 150%   Scaling of deceleration
                                from 0 percent to 150 percent
SET HALT   = 0/ 1, Mxxx   Stop feed acc. to stop reaction,
                                see 6.2.3 and
                                "Braking the drive (STOP, SET HALT/
                                BRAKE)", page 7-38
SET BRAKE  = 0/ 1, Mxxx   Trigger quick stop acc. to quick stop
                                reaction, see 6.2.3 and
                                "Braking the drive (STOP, SET HALT/
                                BRAKE)", page 7-38
SET EGEARPOS = Hxxx      Set run-in reference encoder
                                increments
SET Hxxx    = EGEARPOS   Read run-in reference encoder
                                increments
SET Hxxx    = EGARSPEED  Read reference encoder speed in rpm

SET F[Cxxx] = Value
SET H[Cxxx] = Value
SET M[Cxxx] = Value

```

Indexed assignment of a constant value

Setting integer variable

direct:

```
SET Hxxx = z
```

indexed:

```
SET H[Cxx] = z
```

with 2. variable:

direct:

```
SET Hxxx = Hyyy
```

indexed:

```
SET H[Cxx] = Hyyy
```

with 2. indexed variable:

```
SET Hxxx = H[Cyy]
```

with 2. floating point variable:

```
SET Hxxx = Fxxx
```

Assignment of a floating point variable with limitation to +/- 2147483647
no rounding

with flag:

```
SET Hxxx = Mxxx
```

with counter status:

```
SET Hxxx = Cyy
```

with timer status:

```
SET Hxxx = Zxx
```

via acceleration - direct: ²⁾

```
SET Hxxx +z      Addition
SET Hxxx -z      Subtraction
SET Hxxx *z      Multiplication
SET Hxxx :z      z ≠ 0 1)Division
SET Hxxx % z     Modulo
```

via displacement with constant:

to the right:

```
SET Hxxx >> z      Division Hxxx by 2z
```

to the left:

```
SET Hxxx << z      Multiplication Hxxx with 2z
```

Calculation via second variable - direct: ²⁾

```
SET Hxxx + Hyyy    Addition
SET Hxxx - Hyyy    Subtraction
SET Hxxx * Hyyy    Multiplication
SET Hxxx : Hyyy    Hyyy ≠ 0 1) Division
SET Hxxx % Hyyy    Modulo
```

Calculation via displacement with second variable:

Right:

```
SET Hxxx >> Hyyy    Division Hxxx by 2Hyyy
```

Left:

```
SET Hxxx << Hyyy    Multiplication Hxxx with 2Hyyy
```

Calculation by means of absolute-value generation:

```
SET Hxxx = ABS Hyyy
```

- 1) z or $H_{YYY} = 0$ is not permitted (division by 0)! (error message will be triggered).
- 2) With this operation one must make sure that no value range overflow takes place.

Setting special integer variable

with value of parameter:

direct:

```
SET Hxxx = PARA[n]
```

with value of field parameter:

direct:

```
SET Hxxx = PARA[n,i]
```

with actual values:

direct:

```
SET Hxxx = ACTPOS      Assign actual position value
SET Hxxx = ACTFRQ      Assign actual frequency value (only for U/f)
SET Hxxx = ACTSPEED    Assign actual speed value
SET Hxxx = ACTTORQUE   Assign actual torque
SET Hxxx = ACTCURRENT Assign actual current value
```

with setpoints:

direct:

```
SET Hxxx = REFPOS      Assign position setpoint
```

with input and output functions:

```
SET Hxxx = OSA0        Read value of analog output
                        (0..10.000 = 0V..10V)
SET Hxxx = ISA0        Assign value of analog input 0
                        (0 ... 1.000 = 0V ... 10V).
SET Hxxx = ISA1        Assign value of analog input 1
                        (0 ... 1.000 = 0V ... 10V)
SET Hxxx = Input       Assign input image
SET Hxxx = Output      Assign output image

SET OSA0 = Hxxx        Assign CDB3000 analog output (0..10.000 =
0V..
                        10V).
SET Oppi = 0           Set digital output to Low
SET Oppi = 1           Set digital output to High
SET Oppi = Mxxx        Assign flag value to digital output
```

The function selector of the outputs must be set to PLC.

```
SET REFVAL = Hxxx      Assign setpoint
                        (only for torque/speed control=
SET INPOSWINDOW = HxxxAssign window setpoint reached
                        (only with positioning)
```

Setting floating point variable

direct:

```
SET Fxxx = f
```

with 2. variable:

direct:

```
SET Fxxx = Fyyy      Assignment of floating point variable
```

indexed:

```
SET F[Cxx] = Fyyy    Indexed assignment
```

with 2. indexed variable

```
SET Fxxx = F[Cxx]    Indexed assignment
```

with 2. integer variable:

```
SET Fxxx = Hxxx      Assignment of integer variables
```

via calculation - direct:

```
SET Fxxx + f          Addition of floating constants
SET Fxxx - f          Subtraction of floating constants
SET Fxxx * f          Multiplication of floating constants
SET Fxxx : f          Division of floating constants
```

Calculation via 2. variable - direct:

```
SET Fxxx + Fyyy       Addition of floating variables
SET Fxxx - Fyyy       Subtraction of floating variables
SET Fxxx * Fyyy       Multiplication of floating variables
SET Fxxx : Fyyy       Division of floating variables
```

Calculation by rounding:

```
SET Fxxx = ROUND Fyyy      Mathematically rounded
                           2.8 -> 3.0    -2.8 -> -3.0
```

Calculation by means of absolute-value generation:

```
SET Fxxx = ABS Fyyy       Absolute-value generation -2.8 -> 2.8
SET Fxxx = PARA[Hyyy, Hzzz] Assign field parameter value
SET Fxxx = PARA[Hyyy]     Assign parameter value
SET Fxxx = PARA[n, i]     Assign field parameter value
SET Fxxx = PARA[n]        Assign parameter value
SET Fxxx = ACTFRQ         Actual frequency value (only with U/f)
SET Fxxx = ACTSPEED       Actual speed value
SET Fxxx = ACTTOURQUE     Actual torque value
SET Fxxx = ACTTOURQUE     Actual current value
SET Fxxx = ACTPOS         Assign actual position value
SET Fxxx = REFPOS         Assign position setpoint
SET REFVAL= Fxxx          Assign setpoint via
                           floating point variable
                           (only for torque/speed control)
```

Setting special floating point variable

Set counter

direct:

```
SET Cxx = d
```

with variable:

```
SET Cxx = Hyyy
```

with counter:

```
SET Cxx = Cyy
```

Incrementing / decrementing counter:

```
SET Cxx + d
SET Cxx - d
```

Incrementing / decrementing counter via variable:

```
SET Cxx + Hyyy
SET Cxx - Hyyy
```

Setting and starting timers

After assigning a timer (time counting element) with a value, this value is automatically reduced by 1 every millisecond, until finally the value of 0 is reached.



The timer Z11 must not be used when working with the command WAIT, because this timer is used to execute the WAIT commands.

direct:

```
SET Zxx = t
```

with variable:

```
SET Zxx = Hyyy
```

The timer value is specified in ms.

Set parameter

with integer variable:

```
SET PARA[n] = Hxxx    Direct specification of parameter number
SET PARA[Hxxx] = Hyyy Specification of parameter number via
                      floating point variable
```

with floating point variable

```
SET PARA[n] = Fxxx    Direct specification of parameter number
SET PARA[Hxxx] = Fyyy Specification of parameter number via
                      integer variable
```



Note: Saving the sequential program, the parameters and the travelling data into the Flash-EPROM may also be triggered by the program. (SET PARA [150] =1).

Setting field parameters

with integer variable:

SET Para [n,i] = Hxxx Direct specification of parameter number
 and index
 SET PARA [Hxxx,Hyyy] = Hzzz Specification of parameter number and index via integer variables

with floating point variable:

SET PARA [n,i] = Fxxx Specification of parameter number and index direct
 SET PARA [Hxxx, Hyyy] = Fxxx Specification of parameter number and index via integer variables



Note: The data type must be observed during read / write operations.
 Example: Do not assign floating point values to an integer type parameter (value range violations possible).

Data types	Value range	Function	Suitable for PLC variable
USIGN8	0 ... 255	unsigned	Hxxx, Fxxx
USIGN16	0 ... 65535		
USIGN32	0 ... 4294967295		
INT8	-128 ... 127	Integer, signed	
INT16	-32768 ... 32767		
INT32	-2147483648 ... 2147483647		
INT32Q16	-32767,99 ... 32766,99	32 bit number with standardization 1/65536, i. e. the low-word indicates the fractional digits.	Fxxx
FIXPOINT16	0,00 ... 3276,80	Fixed-point number with standardization 1 / 20, i. e. increment value 0.05	
FLOAT32	see IEEE	32 bit floating point number in IEEE-format	

Table 7.1 Data types

Inverting (INV)

The INV-command can be used to logically invert an integer variable, a flag or the status of a digital output. With this e. g. an output with Low-Level is inverted to High-Level, whereby it can be used in the program as a status indicator.

How to use this function in the sequential program:

Ny INV Hxxx	Logic inverting of an integer variable
Ny INV Mxxx	Logic inverting of a flag
Ny INV Oppi	Logic inverting of a digital output

Travel commands in positioning (GO)

These commands can be used to move the driven positioning axis. These commands must only be used in positioning mode, the setpoint channel must be set to PLC (preset solution with setpoint via PLC). With torque/speed control GO-commands are evaluated as NOP. Effect of the individual positioning modes see chapter 5.2.1.

There are generally five methods to move the axis:

- **Absolute positioning:** Travelling to a certain position (GO A ..)
- **Relative positioning:** Travelling over a certain distance (GO R ..)
- **Endless positioning:** Travelling with defined speed (GO V ...)
- **Start referencing:** (GO 0)
- **Synchronous travel:** Electronic transmission (GO SYN ..)
- with continuation of program (GO ...)

If this command is submitted within the program, the program will immediately continue with the following program line, after the axis has been started. In this way several commands can be processed parallel to an ongoing positioning.

If this command is submitted during an ongoing positioning, the travel to the new target position will be continued with the changed

Travelling with or without continuation of program

speed. The new command is executed immediately, i.e. the position specified in the previous command is no longer approached. Reference for relative positioning is always the last position setpoint.

- without continuation of program (GO W ...)

With this command the next successive program line is only processed after the actual position has reached the position window. As long as the axis is not in the positioning window - e.g. due to a trailing error - the program is not continued.

The "W" is an abbreviation for "Wait", GO W = "go and wait".

Travelling with continuation

Position or path via variable / speed via variable

```
GO A Hxxx V Hyyy      Absolute travel by value of Hxxx
                       with speed Hyyy
                       (program processing continues)
GO R Hxxx V Hyyy      Relative travel by value of Hxxx
                       with speed Hyyy
                       (program processing continues)
```

Position via variable / speed via parameter

```
GO A Hxxx      Absolute travel by value of Hxxx
                (program processing continues)
GO R Hxxx      Relative travel by value of Hxxx
                (program processing continues)
```

Relative travel commands with continuation must not be processed in a "short" endless loop, as this would lead to a position overflow. See following example:

```
N010 SET H001 = 360
N020 GO R H001
N030 JMP N020
```

Position or path from table

```
GO T[Hxxx]      Travel acc. to table entry
                 (program processing continues)
GO T[Cxx]       Travel acc. to table entry
                 (program processing continues)
GO T[xxx]       Travel acc. to table entry
                 (program processing continues)
```

Travelling without continuation

Position or path via variable / speed via variable

```
GO W A Hxxx V Hyyy  Absolute travel by value of Hxxx
                    with speed Hyyy
                    and wait for further program processing until
                    target position is reached
GO W R Hxxx V Hyyy  Relative travel by value of Hxxx
                    with speed Hyyy
                    and wait for further program processing until
                    target position is reached
```

Position via variable / speed via parameter

```
GO W A Hxxx      Absolute travel by value of Hxxx
                  and wait for further program processing until
                  target position is reached
GO W R Hxxx      Relative travel by value of Hxxx
                  and wait for further program processing until
                  target position is reached
```

Position or path from table

```
GO W T[Hxxx]     Travel acc. to table entry Hxxx,
                  wait until position is reached
GO W T[Cxxx]     Travel acc. to table entry Cxxx,
                  wait until position is reached
GO WT[xxx]       Travel acc. to table entry,
                  wait until position is reached.
```

Referencing

Referencing is performed using the specified referencing type and the associated speeds (727 HOSPD).

If this command is submitted within a program, the next successive set will only be effective, after referencing has been completed.

```
GO 0             Referencing is performed,
                  in dependence on the method specified in parameter
730
                  depending on software status
GO 0 + Hxxx      Referencing is performed, position
                  0 results from this. Thereafter this zero
                  position is set to the value specified in Hxxx.
```

The GO 0 - command is flank triggered. Referencing can therefore only be stopped by a cancellation condition (e. g. STOP B).

The status of referencing can be monitored with the special flag STA_HOMATD:

Example for referencing with status query:

```
N010 SET H000 = 30           ; (30 degree zero offset)
N020 GO 0 + H000
N030 JMP (STA_HOMATD = 1) N050 ; HOMATD = 1 -> Reference point
                              ; defined
                              ; HOMATD = 0 -> Reference point
                              ; not defined
N040 JMP N030                ; Return in query
N050 ....                    ; further program run
```

after referencing the thus detected zero position will have the value 30° assigned (in the device)

Endless travel

via variable:

```
GO V Hxxx      Hxx= Index of variables with speed value
```

The sign of the value in Hxxx determines the travel direction.

Speed synchronism

Switching on synchronous travel:

```
GOSYN 1
```

Switching off synchronous travel:

```
GOSYN 0
```

With speed synchronism (configuration of input see chapter 6.2.4) the speed of the reference encoder in rpm is switched to the setpoint structure. The speed acceleration ramps (see chapter 6.2) are active, i.e. "soft" coupling and decoupling.



Note: Speed synchronism is only active with speed control.

The speed setpoint of the reference sensor always refers to the motor shaft. When using a gearbox on motor and target and the drive shaft speed is to be determined by the reference sensor, the gearbox ratio must be parameterized in the reference sensor configuration.

*Angular synchronism
(electronic transmission)*

With angular synchronism (configuration of input see chapter 6.2.4) the drive controller converts the incoming square wave pulses of a reference encoder directly to a position setpoint and approaches this point in a position controlled manner.

The configuration of the reference encoder input is described in detail in chapter 6.2.4.

Switching on synchronous travel:

```
GOSYN 1
```

Switching off synchronous travel:

```
GOSYN 0
```

After switching on synchronous travel with the command GOSYN 1 the sequential program is immediately continued with the next successive set.



Note: Switching synchronous travel on / off occurs abrupt, without limitation of the axis dynamics by ramps. Soft coupling / decoupling on a rotating leading axis is not possible.

The reference sensor position refers to the motor shaft. The unit is always in increments (65536 Incr = 1 motor revolution). If the reference sensor position is to be directly related to the output shaft, the transmission ration must be entered for the reference sensor. A transmission ratio in the standardizing assistant will be ignored when using the reference sensor.

Example for the CDB3000:

System structure:

- HTL reference sensor as setpoint specification connected to terminal X2 on CDB3000.
- CDB3000 with gear motor ($i = 56/3$)
- A transmission ratio of 56/3 was entered in the standardizing assistant (under basic settings).

Conclusions:

- with a reference sensor transmission ratio of 1/1 the reference sensor setpoint refers to the motor shaft of the gear motor.
- with a reference sensor transmission ratio of 56/3 the reference sensor setpoint refers to the output shaft of the gear motor.

Position and speed of the reference encoder can be read with the help of special PLC variables:

```
SET Hxxx = EGEARPOS; Reading the reference encoder position in increments
```

The submitted reference encoder increments are the actual increments of the reference encoder, multiplied with the transmission ratio of the reference encoder.

```
SET Hxxx = EGARSPEED; Reading the reference encoder speed in rpm
```

The output is the reference encoder speed, multiplied with the transmission ratio of the reference encoder.

The position of the reference encoder can also be changed via the PLC:

```
SET EGEARPOS = Hxxx; Setting the reference encoder position in increments
```

A GOR-command (relative positioning) during synchronous travel results in a superimposed positioning.

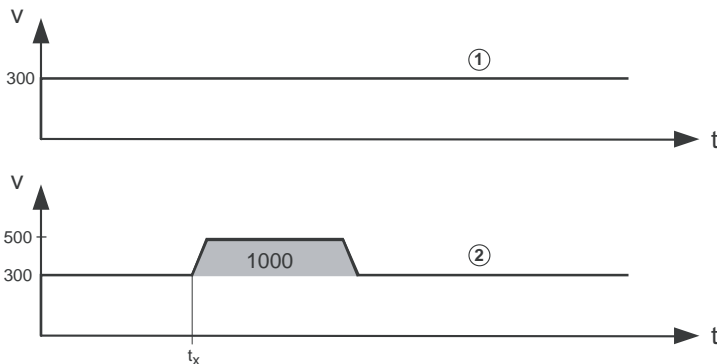

(1) leading axis, (2) following axis

Fig. 7.4 Relative positioning during synchronous travel. t_x =time of command `GO R H000 V001` with $H000 = 1000$ and $H001 = 200$

A GOA-command (absolute positioning) during synchronous travel aborts this travel. The axis continues travelling with the transmitted travelling speed and performs the requested absolute positioning, by observing the set ramps.

GO A and GO R positions, as always, refer to the output shaft. The required transmission ratio can be configured through the standardizing assistant.

Path optimized positioning of a round table

The target position is specified as an absolute value and the positioning controller moves the axis in the direction with the shortest path. Relative movements do not take place in a path optimized way. See also chapter 5.2.3.



This type of positioning assumes that an endless travel path has been selected. For the round table function the settings in the travel profile are decisive. If round table function, direction optimization and length of circumference are specified there under, the commands will be executed in a path optimized manner.

Braking the drive (STOP, SET HALT/BRAKE)

Various commands with and without controller stop are available to brake the drive.

Stop feed

With the command

```
SET HALT = 1
```

the drive is braked to standstill according to the reaction "Stop Feed" (see chapter 6.2.3). The drive thus remains energized.

With the command

```
SET HALT = 0
```

the drive is set in motion again with the previously specified travel set. The braking process can be terminated at any time.

Quick stop

With the command

```
SET BRAKE = 1
```

the drive is braked according to the reaction "Quick Stop" (see chapter 6.2.3). The drive controller is in "Quick stop" system state. The controller is now switched off, if switching off has been parameterized in the quick stop reaction and if it has been enabled via PLC (SET ENCTRL = 1, control location PLC).

With the command

```
SET BRAKE = 0
```

the quick stop condition is terminated. This command must always be executed before the drive can be switched on again. Termination of the quick stop and return to the previous travel set is possible, as long as the drive is energized.

Braking with deceleration ramp (only positioning)

For normal braking with programmed deceleration ramp the command

```
STOP B
```

is available. The braking process cannot be aborted. The travel set that had been valid when the STOIP command was triggered, becomes invalid. The command is valid with positioning.

Braking with quick stop ramp (only positioning)

For quick braking with quick stop ramp the command

```
STOP M
```

is available. The braking process cannot be aborted. The travel set that had been valid when the STOIP command was triggered, becomes invalid. The command is valid with positioning.

Emergency stop (speed = 0) and shut-down of control (only positioning)

for quickest possible braking (speed setpoint=0) and subsequent shut down of the control the command

```
STOP 0
```

is available. The control is only switched off if it had been switched on via PLC (SET ENCTRL = 1, control location PLC).

The braking process cannot be aborted. The travel set that had been valid when the STOIP command was triggered, becomes invalid. The command is valid with positioning.

Wait commands (WAIT)

Time

This command can be used to realize a certain time delay in milliseconds. After expiration of this time the program will continue with the next successive program line. The WAIT command is executed via the timer Z11.

direct:

```
WAIT d
```

via variable:

```
WAIT Hxxx
```

Axis status

The program is continued, if the following condition is fulfilled.

Position window reached

```
WAIT REF      Actual position in position window 1)
```

Axis stopped:

```
WAIT ROT_O    Position setpoint = Target position 2)
```

- 1) Positioning finished,
Output "Axis in position" will be set
- 2) Positioning mathematically finished,

Parameter write access

```
WAIT PAR      Wait until parameter write access has taken place.
```

If the parameter write access is mandatory for the further processing of the program, a WAIT PAR should be inserted after the parameter assignments.

Example program

```
%P00
N010 SET H000 = 1           ; Assign value 1 to variable H000
N020 SET PARA[460,1] = H000 ; Write (field) parameter 460,
                           ; Index 1
N030 SET PARA[460,2] = H000 ; Write (field) parameter 460,
                           ; Index 2
N040 SET PARA[270] = H000  ; Write parameter 270
N050 WAIT PAR              ; Wait with program processing until
                           ; all parameter write access
                           ; have taken place
END                         ; End of program
```

7.4 PLC control and parameters

An uncomplicated setting of the specified PLC control parameters enables the PLC function mask (extended main window -> PLC or via "Basic settings/PLC with the corresponding PLC presetting):

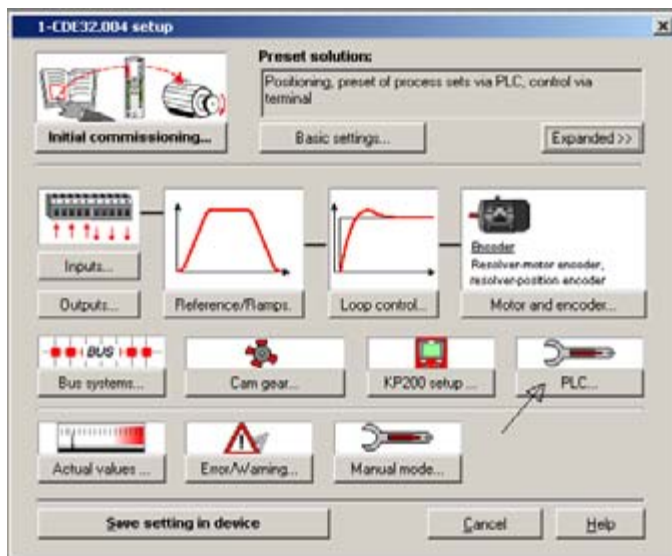

Fig. 7.5 DRIVEMANAGER - PLC function mask

7.4.1 PLC variables

All PLC variables are shown by means of parameters. These parameters can be edited via the DRIVEMANAGER in a PLC function mask (see Fig. 7.5).

DRIVEMANAGER	Meaning	Value range	Changing ONLINE	Parameter
Integer variables (32 bit)	Integer variables are integer numerical values. In combination with floating point variables or parameters the digits after the decimal point are not taken into consideration. Rounding will also not take place. Access in the sequential program H000...H127	2^{-31} to 2^{31}	yes	460-PLC_H (_PLCP)
Flag (0/1)	Access in the sequential program M000...M255	0/1	yes	461-PLC_M (_PLCP)
Timer (32 bit)	Time base 1 ms Access in the sequential program Z00...Z11 Timers are set to a certain value and run back to 0.	0 to 2^{32}	yes	462-PLC_Z (_PLCP)
Counter for indexed addressing (8 bit)	Access in the sequential program C00...C10	0 to 65535	yes	463-PLC_C (_PLCP)
Image of the digital outputs (bit coded)	The image can also be written in the program as special variable OUTPUT. OSD00-OSD02 Bit 0 - Bit 2 OED00-OED03 Bit 4 - Bit 6 OV00-OV01 Bit 7 - Bit 8 In order to set outputs from within the program, the corresponding function selector must be set to F0ppi = PLC.		yes	464-PLC_O (_PLCP)
Floating point variables	Access in the sequential program F000...F127	$-3,37 \times 10^{38}$ to $3,37 \times 10^{38}$	yes	465-PLC_F (_PLCP)
Image of digital and analog inputs (bit coded)	The image can also be written in the program as special variable INPUT. ISD00-ISD03 Bit 0 - Bit 3 IED00-IED07 Bit 4 - Bit 11 ISA00 - ISA01 Bit 12 - Bit 13		read only	466-PLC_I (_PLCP)

Table 7.2 PLC Variables and flags

7.4.2 PLC control parameters

The PLC control parameters enable a flexible configuration of the PLC-program or of its sequence.

DRIVEMANAGER	Meaning	Changing ONLINE	Parameter
Name of the PLC program (Project name)	The project name is defined when generating the sequential program (text declaration). The name directly designates the text declaration file (project name.txt) (max. 32 characters without special characters, spaces will be ignored)	yes	468-PLCPJ (_PLCC)
Operating status of the sequencing control	This parameter enables the starting/stopping (depending on parameter 452-PLCCT=PARA) or indicates the current operating status of the sequential program.	yes	450-PLCST (_PLCC)
	OFF (0) PLC program sequence shut-down / switched off		
	GO(1) Start PLC program sequence / in progress		
BRKPT(2)	PLC program sequence interrupted The GO command continues the operation. The program processing can be interrupted (BRKPT) or ended (OFF) with the parameter at any time, irrespective of the control location. With GO the processing of the program can be resumed from the cancellation line, as long as the control location is still valid (e.g. terminal still set). If this conditions is no longer fulfilled, the parameter is set to OFF.		
Current program line	Shows the currently processed program line. The line number is also visible in the digital oscilloscope.	read	451-PLCPL (_PLCC)

Table 7.3 PLC control parameters

DRIVEMANAGER	Meaning		Changing ONLINE	Parameter
Start conditions of the sequencing control	Parameter PLCCT defines the location from which the sequential program is started.		yes	452-PLCST (_PLCC)
	TERM(0)	PLC start via input The function selector for an input must be set to Fixxx = PLCGO. (0 -> Program stopped, 1 -> Program started)		
	PARA(1)	PLC start via parameter "Operation status" Manual change of operation status PLCST		
	AUTO(2)	Automatic PLC start when starting the device, parameter "Operation status" is set to GO and serves as status indicator		
	CTRL(3)	PLC start together with activation of controller PLC start together with deactivation of controller		
	BUS(4)	PLC is started via field bus in EasyDrive-ProgPos control word with the bit "Start PLC". When resetting the bit the PLC-sequence is directly terminated by jumping to line 0.		
Program stop in line x (breakpoint)	The program is interrupted at the line specified under PLCBN; the parameter 450-PLCST changes to status BRKPT. The program is restarted with 450-PLCST=GO(1).		yes	455-PLCBN (_PLCC)
Start with program line (0 = first program line).	Processing of the program starts with the line specified in PLCSN. This is very sensible, if a program contains different independent routines.			456-PLCSN (_PLCC)

Table 7.3 PLC control parameters

7.5 PLC program examples

The examples in this chapter are solely intended as programming exercises. Neither the problem definitions, nor the suggested solutions have been checked under the aspects of safety.

The examples shall demonstrate the possible solutions with the integrated sequencing control and what a typical program section could look like. A preset solution, which access the PLC, must be set up, e.g. "PCT_3 (18) positioning, travel set specification via PLC, control via terminal".

The specified values for path unit, speed and acceleration are only examples and should strictly be adapted to the application described hereunder.

Basis for these examples is a gear motor with a rated speed of 1395 min⁻¹ and a transmission ratio of $\ddot{u}=9,17$.

Lust Antriebstechnik GmbH therefore does not assume any responsibility and will not accept any liability for damage resulting from the type of use of this programming material or of parts thereof.

The numerical values for path, speed and acceleration solely refer to the programming units specified in the positioning controllers.

7.5.1 Conveyor belt

After the start the conveyor belt drive shall advance the belt by 1m (corresponds with 10 revolutions of the output shaft) with a speed of 35 mm/s. After a waiting time of 5 s the process shall be repeated, until the input is reset. (Input used ISD03).

Setting units and standardization in the standardization assistant:

Position:	mm
Speed	mm/s
Acceleration:	mm/s ²
Feed constant:	1000 mm corresponds with 10 revolutions of the output shaft
Gear:	Motor shaft revolutions 917 Output shaft revolutions 100

Adapting the travel profile:

Max. speed:	250 mm/s
Max. starting acceleration:	50 mm/s ²
Max. braking acceleration:	50 mm/s ²

The example program can be transferred to the controller, after referencing has been parameterized as described in chapter 5.2.4.

```
%TEXT (Conveyor Belt)
DEF H001 = Path
DEF H002 = Speed
END

%P00
N001 SET H001 = 1000 ; Path in mm
N002 SET H002 = 35 ; Speed in mm/s

N010 GO 0 ; Perform referencing
N020 JMP (IS03=0) N020 ; continue, if input = high
N030 GO W R H001 V H002 ; Travel to position direction with 35
mm/s
N040 WAIT 5000 ; Wait 5 s
N050 JMP N020 ; Restart cycle
END
```

7.5.2 Absolute positioning

The fourth position is to be approached with a speed of $v=80$ mm/s absolute, followed by a wait period of always 1 s. The travel back to initial position is to take place with three times the speed (240mm/s).

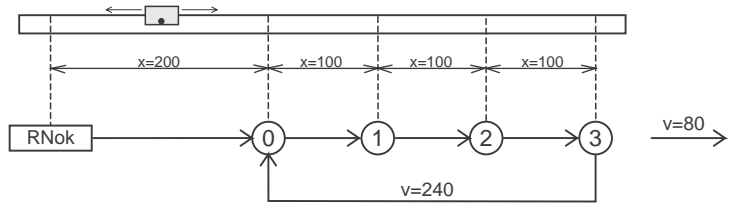

Fig. 7.6 Approach position

Setting units and standardization in the standardization assistant:

Position:	mm
Speed	mm/s
Acceleration:	mm/s ²
Feed constant:	100 mm corresponds with 1 revolution of the output shaft
Gear:	Motor shaft revolutions 917 Output shaft revolutions 100

Adapting the travel profile:

Max. speed:	250 mm/s
Max. starting acceleration:	50 mm/s ²
Max. braking acceleration:	50 mm/s ²

The example program can be transferred to the controller, after referencing has been parameterized as described in chapter 5.2.4.

Positions and speeds are directly transferred as values, the specification of the acceleration takes place according to the machine parameters.

```
; Standardization in s=mm and v=mm/s
%TEXT (Absolute Positioning)
DEF H000 = Position_0
DEF H001 = Position_1
DEF H002 = Position_2
DEF H003 = Position_3
DEF H004 = Speed_v1
DEF H005 = Speed_v2
END

%P00
N001 SET H000 = 200
N002 SET H001 = 300
N003 SET H002 = 400
N004 SET H003 = 500
N005 SET H004 = 80
N006 SET H005 = 240

N020 GO 0 ; Referencing
N030 GO W A H000 V H004 ; Approach initial position
N040 WAIT ROT_0 ; Wait until axis has stopped
N050 WAIT 1000 ; Wait 1 s
N060 GO W A H001 V H004 ; Approach position 1 and wait until
; axis has stopped

N070 WAIT 1000
N080 GO W A H002 V H004 ; Position 2
N090 WAIT 1000
N100 GO W A H003 V H004 ; Position 3
N110 WAIT 1000
N120 GO W A H000 V H005 ; return to initial position

N130 JMP N050
END
```

7.5.3 Relative positioning

In the previous example the axis has always travelled further by the same distance, this opens the possibility for a solution with relative positioning. A counter always holds the actual position; units and standardization see previous example.

```
%TEXT (Relative Positioning_1)
DEF H000 = Position_0
DEF H001 = Distance_between_positions
DEF H002 = Speed_v1
DEF H003 = Speed_v2
END

%P00
N001 SET H000 = 200           ; Position 0 in mm
N002 SET H001 = 100          ; Distance between two positions in mm
N005 SET H002 = 80           ; Speed in mm/s
N006 SET H003 = 240          ; Speed in mm/s

N010 GO 0                    ; Referencing
N020 GO W A H000 V H002      ; Approach initial position and wait
N030 SET C00 = 0             ; Set counter = 0
N040 WAIT 1000
N050 GO W R H001 V H002      ; Approach next position
N060 SET C00+1               ; Count position counter
N070 WAIT 1000
N080 JMP (C00 != 3) N050     ; Position 3 not yet reached
N090 GO W A H000 V H003      ; return to initial position
N100 JMP N030
END
```

The solution is even simpler and more elegant when doing without the counter and the comparison is made with the position setpoint (SP).

```
%TEXT (Relative Positioning_2)
DEF H000 = Position_0
DEF H001 = Distance_between_positions
DEF H002 = Speed_v1
DEF H003 = Speed_v2
END

%P00
N001 SET H000 = 200           ; Position 0 in mm
N002 SET H001 = 100          ; Distance between two positions in mm
N003 SET H002 = 80           ; Speed in mm/s
N004 SET H003 = 240          ; Speed in mm/s
N005 SET H004 = 500          ; Position setpoint 3, used for comparison

N010 GO 0                    ; Referencing
N020 GO W A H000 V H002      ; Approach initial position and wait
N030 WAIT 1000

N040 GO W R H001 V H002      ; Approach next position
N050 WAIT 1000
N060 JMP (REFVAL < H004) N040 ; Position 3 not yet reached

N070 GO W A H000 V H003      ; return to initial position

N080 JMP N030
END
```

7.5.4 Sequential program

Here the positioning controller is used as a freely programmable sequencing control for a speed profile.

An endless conveyor belt is operated with two speeds. The belt is to be stopped when a target position (≥ 10000) has been reached. The cycle is repeated by a new release input. In order to maintain the structure clear, sub-programs are used. The main program takes over the initialization and call up the sub-programs 1 to 3 in an endless loop.

Parameterization of inputs (DRIVEMANAGER):	IS00	Start(1) = Start of control
	IS01	PLC (35) = Input can be used in sequential program
	IS02	PLC (35) = Input can be used in sequential program
	IS03	/HALT (Feed release, must have High-Level)
Input (Program):	ISD01	Selection of speed $0 = v1 / 1 = v2$
	ISD02	Release
Output (Program)	OSD00	Target position reached

Setting units and standardization in the standardization assistant:

Position:	Degree
Speed	Degree/s
Acceleration:	Degrees/s ²
Feed constant:	360° corresponds with 1 revolution of the output shaft
Gear:	Motor shaft revolutions 917
	Output shaft revolutions 100

Adapting the travel profile:

Max. speed:	900 degree/s
Max. starting acceleration:	320 Degrees/s ²
Max. braking acceleration:	320 Degrees/s ²

The example program can be transferred to the controller, after referencing has been parameterized as described in chapter 5.2.4.

```

%TEXT (Sequencing control)
DEF H000 = Speed
DEF H001 = Position
END

%P00                                ; Main program

N005 GO 0                            ; Perform referencing
N010 SET M000 = 1                    ; Flag = 1:
                                     ; Axis is not to be started
N015 SET M001 = 0                    ; Flag = 0: Axis is not moving
N020 SET H001 = 10000                ; Target position for comparison

N025 CALL N045                       ; Sub-program query inputs
N030 CALL N080                       ; Sub-program start axis
N035 CALL N105                       ; Sub-program position comparison
N040 JMP N025                        ; Repeat

; Sub-program 1: Query inputs

N045 JMP (M001 = 1) N075 ; If drive is in motion, jump to RET
N050 JMP (IS02 = 0) N075 ; no query
N055 SET M000 = 0        ; Start took place, set flag = 0

N060 SET H000 = 300     ; Set speed 1
N065 JMP (IS01 = 0) N075 ; Speed 1 selected
N070 SET H000 = 600     ; Speed 2 selected + set
N075 RET

; Sub-program 2: Start axis

N080 JMP (M000 = 1) N100
N085 GO R H001 V H000 ; Axis starts with
                       ; speed H000, target position H001
N090 SET M000 = 1    ; Release detected, reset flag
N095 SET M001 = 1    ; Drive in motion
N100 RET

; Sub-program 3: Position comparison

N105 JMP (REF = 1) N120
N110 SET OS00 = 0
N115 JMP N135
N120 SET M000 = 1
N125 SET M001 = 0    ; Drive stopped
N130 SET OS00 = 1
N135 RET

END

```

8 Speed Control "OpenLoop" for CDE/CDB3000

8.1	Preset solutions	8-2
8.2	General functions	8-3
8.2.1	Data set changeover	8-3
8.2.2	Speed profile generator "OpenLoop"	8-5
8.2.3	Limitations/Stop ramps	8-8
8.3	"OpenLoop" motor control method	8-10
8.3.1	Start current controller	8-11
8.3.2	Vibration damping controller	8-13
8.3.3	Current limit controller	8-14
8.3.4	DC-holding current controller	8-16
8.3.5	v/f-characteristics curve	8-17
8.4	Speed control "OpenLoop" with 0-10 V or fixed speeds	8-19
8.5	Speed control "OpenLoop" with setpoint and control via field bus	8-22

8.1 Preset solutions

Pre-set solutions are complete parameter datasets which are provided to handle a wide variety of typical application movement tasks. The positioning controllers are automatically configured by setting a preset solution. The parameters for

- the control location of the positioning controller,
- the reference source,
- the assignment of signal processing input and outputs and
- the type of control

are the focal points of the setting.

The use of a pre-set solution considerably simplifies and shortens the commissioning of the positioning controller. By changing individual parameters, the preset solutions can be adapted to the needs of the specific task.

A total of three preset solutions covers the typical areas of application for "OpenLoop" speed control with the closed-loop controllers.

Abbreviation	Reference source	Control location/ Bus control profile	Chapt .	Additionally required Documentation
VSCT1	0-10V analog	I/O-terminals	8.4	
VSCC1	CAN _{open} field bus interface	CAN _{open} field bus interface - EasyDrive-Profile "Basic"	8.5	CAN _{open} data transfer protocol
VSCB1	Field bus communication module (Profibus)	Field bus communication module (Profibus) - EasyDrive-Profile "Basic"	8.5	Profibus data transfer protocol

Table 8.1 Preset solutions - in speed controlled operation

All pre-set solutions have an individual window for basic settings in DRIVEMANAGER. Tabs or control buttons contained therein differ in their general and special functions. The general functions are described in chapter 8.2, the motor control method in chapter 8.3 and the special functions for the respective presettings in chapters 8.4 and 8.5.

8.2 General functions

8.2.1 Data set changeover

Function	Effect
<ul style="list-style-type: none"> Online switching between two data sets is possible 	<ul style="list-style-type: none"> Matching the dynamics of the motor to the application Operation of two different motors with one positioning controller

The "OpenLoop" speed control contains two data sets. Switching to the second data set CDS2

- via terminals,
- when reaching the speed limit,
- when reversing the sense of rotation or
- access by bus

is possible.



Note: Online changeover between data sets CDS1 and CDS2 is possible.



Fig. 8.1 Function mask "Data set changeover"

Parameters for data set changeover

DRIVEMANAGER	Function	Value range	WE	Unit	Parameter
Changeover	Control location for changeover of data set (CDS)	see Table 8.4	OFF		651-CDSSL (_VF)
Speed threshold SLIM	Speed limit for changeover to CDS	-32764 ... 32764	600	min ⁻¹	652-FLIM (_VF)
-	Display of active data set (CDS) (not shown in DRIVEMANAGER)	see Table 8.5	0		650-CDSAC (_VF)

Table 8.2 Parameters for data set changeover

Explanations

- An overview of function areas with parameters for the second characteristics curve data set can be found in Table 8.3.

Function areas with parameters for characteristics curve data sets

Function area	Parameter
Fixed CDS speeds	all parameters
Speed profile generator "OpenLoop"	Acceleration and deceleration ramps
Current limit controller	Limit value and function selector
v/f-characteristics curve	all parameters
Start current controller	Setpoint, reduced setpoint and timer
Vibration damping controller	Amplification

Table 8.3 Function areas with parameters in the second data set (CDS)

Possibilities of data set changeover

BUS	KP/DM	Function
0	OFF	no changeover <ul style="list-style-type: none"> CDS 1 active
1	SILIM	Changeover when exceeding the speed setpoint of the value in parameter SILIM <ul style="list-style-type: none"> CDS 2, is speed > SLIM, otherwise CDS 1
2	TERM	Changeover via digital input <ul style="list-style-type: none"> CDS 2, if IxDxx = 1, otherwise CDS 1

Table 8.4 Settings for variants of data set changeover

BUS	KP/DM	Function
3	ROT	Changeover when reversing the sense of rotation <ul style="list-style-type: none"> CDS 2, if ccw-rotation, otherwise CDS 1
4	SIO	Changeover via SIO <ul style="list-style-type: none"> CDS 2, if control bit is set, otherwise CDS 1
5	CAN	Control via CANopen interface <ul style="list-style-type: none"> CDS 2, if control bit is set, otherwise CDS 1
6	OPTN	Changeover via field bus to optional slot <ul style="list-style-type: none"> CDS 2, if control bit is set, otherwise CDS 1
7	SLABS	Changeover when exceeding the speed setpoint of the absolute value (value formation) in parameter SILIM <ul style="list-style-type: none"> CDS2, if speed > (SILIM), otherwise CDS1

Table 8.4 Settings for variants of data set changeover

Active characteristics curve data set display with 650-CDSAC

BUS	KP/DM	Function
0	CDS1	characteristics curve data set 1 (CDS1) active
1	CDS2	characteristics curve data set 2 (CDS2) active

Table 8.5 Display of active data set

8.2.2 Speed profile generator "OpenLoop"

Function	Effect
<ul style="list-style-type: none"> Setting of acceleration and deceleration ramps for the rotary speed profile Setting of a slip for the start and end points of the linear ramp 	<ul style="list-style-type: none"> Matching the dynamics of the motor to the application Jerk reduced moving of the drive

The ramps can be selected separately for each data set.

The parameter MPTYP (linear/jerk limited) and JTIME can be used to slip linear ramps at their end points to limit the appearance of jerks.

Type of movement	Setting
dynamic, jerky	MPTYP = 0, linear ramp without slip
Protecting mechanics	MPTYP = 3, smoothened ramp by slip by JTIME [ms].

Table 8.6 Activation of the jerk limitation

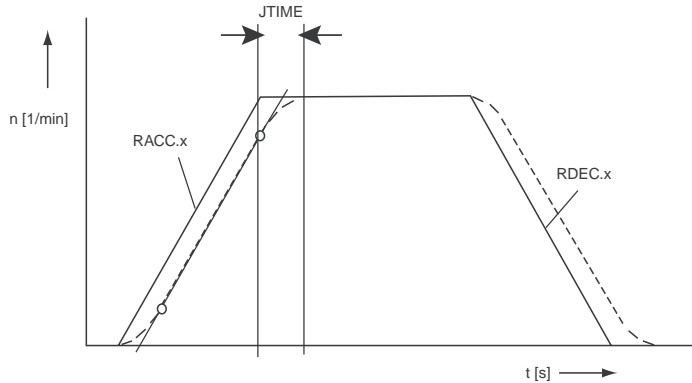

Fig. 8.1 Speed profile generator for "OpenLoop" speed control

Due to the jerk limitation the acceleration and deceleration times rise by the slip time JTIME. The rotary speed profile is set in the DRIVEMANAGER according to Fig. 8.2.

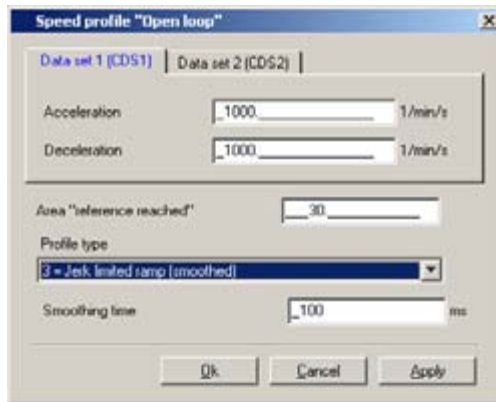

Fig. 8.2 Function mask speed profile "OpenLoop"

DRIVEMANAGER	Value range	WE	Unit	Parameter
Acceleration (Data set dependent)	0 ... 32760	1000	min ⁻¹ /s	620.x_RACC ¹ (_VF)
Deceleration (Data set dependent)	0 ... 32760	1000	min ⁻¹ /s	621.x_DECR ¹ (_VF)
Area "Reference reached"	0 ... 32760	30		230_REF_R (_OUT)

Table 8.7 Parameters speed profile generator "OpenLoop"

DRIVEMANAGER	Value range	WE	Unit	Parameter
Type of profile 0: Linear ramp 3: Jerk limited ramp 1, 2: not supported	0 ... 3	3	-	597_MPTYP (_SRAM)
Slip	0 ... 2000	100	ms	596_JTIME (_SRAM)

1) Field parameters; Index "x" = 0: Data set CDS1, index "x" = 1: Data set CDS2

Table 8.7 Parameters speed profile generator "OpenLoop"

Parameter 230-REF_R can be used to define a speed range in which the setpoint after the profile generator may differ from the input setpoint, without the message "Reference value reached" (REF) becomes inactive. Setpoint fluctuations caused by setpoint specification via analog inputs can therefore be taken into account.

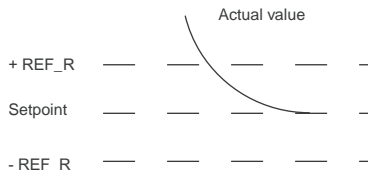

Ramp settings can be made independently from each other. A ramp setting of zero means jump in setpoint.

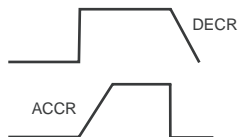

8.2.3 Limitations/ Stop ramps

Function	Effect
<ul style="list-style-type: none"> Limitation of motor current and speed 	<ul style="list-style-type: none"> Setting maximum and minimum values

The maximum permissible currents are limited to a percentage of the nominal device current and the maximum speed to the nominal motor speed.

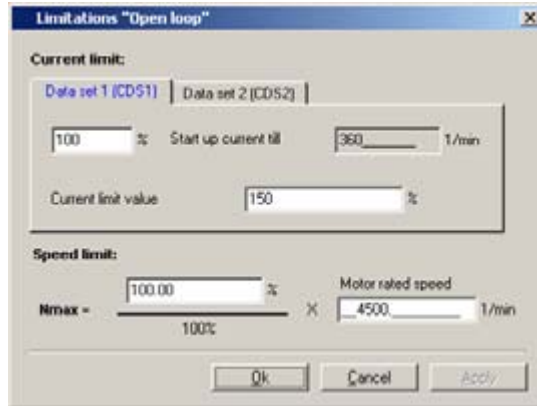

Fig. 8.3 Function mask "OpenLoop" limitations

DRIVEMANAGER	Function	Value range	WE	Unit	Parameter
Start current	The start current (motor control function "start current controller") is controlled up to a defined speed in a data set dependent way.	0 ... 180 of the nominal device current	100	%	601.x_CLCN ¹⁾ (_VF)
Current limit value	The current limit (motor control function "current limit controller") is limited in a data set dependent way.	0 ... 180 of the nominal device current	150	%	632.x_CLCL ¹⁾ (_VF)
Speed limitation	Percentage limitation of the speed setpoint	0.00 ... 999.95 of the rated motor speed	100.00	%	813_SCSMX (_CTRL)
Rated motor speed		0 ... 100000	1500	rpm	157_MOSNM (_MOT)

¹⁾ Field parameters; Index "x" = 0: Data set CDS1, index "x" = 1: Data set CDS2

Table 8.8 Parameters for the "OpenLoop" limitation function

The stop ramps are described with the general software function in chapter 6.2.3 (stop ramps). Various stop ramps or reactions can be adjusted:

- Switching off of closed-loop control
- Stop feed
- Quick stop
- Error

1

2

3

4

5

6

7

8

A

8.3 "OpenLoop" motor control method

With default setting "OpenLoop" for speed control the drive controller uses the motor control method VFC. This control method does not require any speed feedback, because the drive controller works with v/f - characteristics curve control. Function, see control technological block diagram (Fig. 8.4).

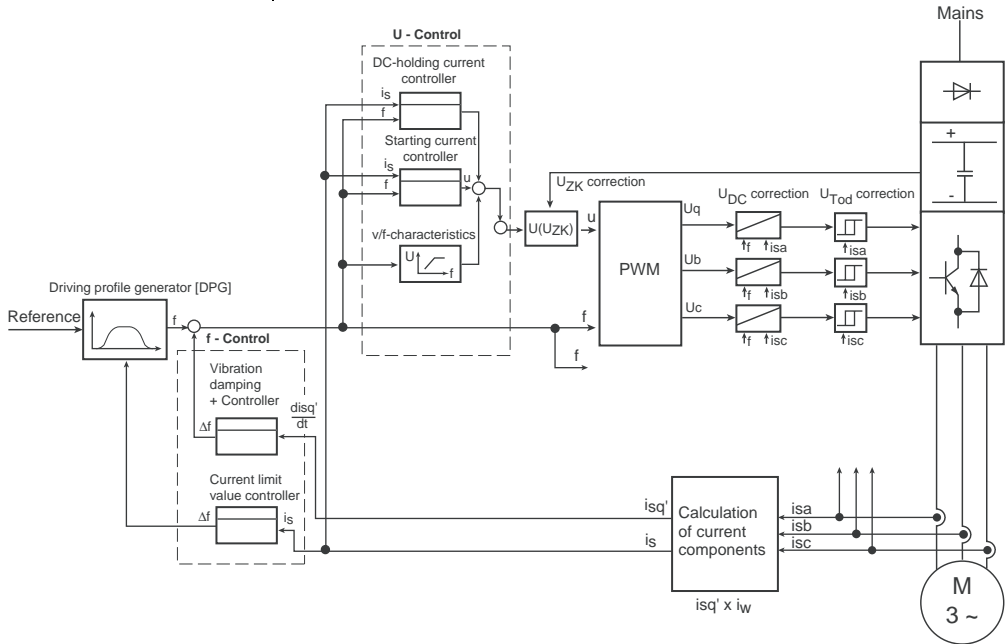

Fig. 8.4 Control technological block diagram for "OpenLoop" motor control method

1.

All settings are made in the "Control" function.



2.

In the function mask all active functions are shown with a green status display.

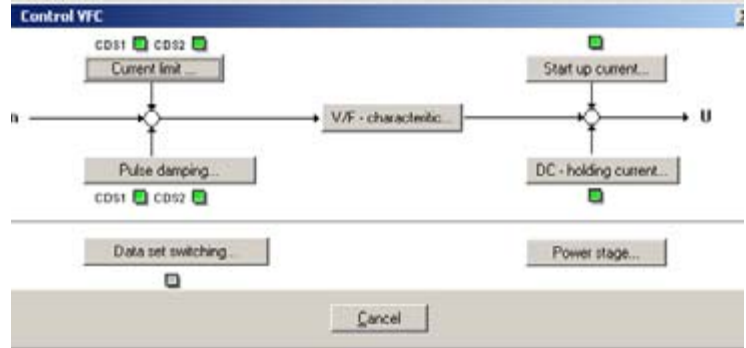

Fig. 8.5 Function mask "OpenLoop" control

8.3.1 Start current controller

Function	Effect
<ul style="list-style-type: none"> The motor is "preloaded" with a certain current via a P-controller 	<ul style="list-style-type: none"> Increase of starting torque up to the preset speed limit



Fig. 8.6 Function mask "Start current controller"

DRIVEMANAGER	Meaning	Value range	WE	Unit	Parameter
Function	Controller OFF/ON	OFF/CIACC	OFF(0)	-	600_CISEL (_VF)
Start current ²⁾	Start current in % of the drive controller rated current	0 ... 180 of the nominal device current	100	%	601.x_CICN ⁴⁾ (_VF)
Automatic changeover to ...	Timer for changeover to the reduced start current. Changeover to the reduced start current setpoint after the time has run out.	0 ... 60	2	s	605.x_CITM ⁴⁾ (_VF)
to start current ³⁾	Reduced start current after time CITM has run out	0 ... 180	50	%	602.x_CICNR ⁴⁾ (_VF)
Speed limit ¹⁾	Speed at which the P-controller is switched off.	% of rated motor speed MOSNM	8	%	603_CISM (_VF)
<p>1) From cut-off speed the controlled start current is controlled back to the normal operating current of the v/f - characteristics curve. The transition range is fixed to 5% of the rated motor frequency (MOFN).</p> <p>2) The start current setting can also be found in the basic setting mask under the option "Limitation".</p> <p>3) The changeover can be deactivated by setting the start current and the reduced start current to the same value.</p> <p>4) Field parameter; index "x" = 0: Data set CDS1, index "x" = 1: Data set CDS2</p>					

Table 8.9 Parameters for start current controller



Note Start current setpoint:

Please remember that the start current setpoint must always be lower (at least 25%) than the rated current of the current limit controller.

8.3.2 Vibration damping controller

Function

- The controller reduces the oscillation propensity by means of automatic dynamic speed or frequency changes.

Effect

- This control function dampens the vibration behaviour of motors with rotor shafts which are susceptible for bending.
- This control function has an additional dampening effect on acceleration processes with mechanical components having high elasticity and/or lots.

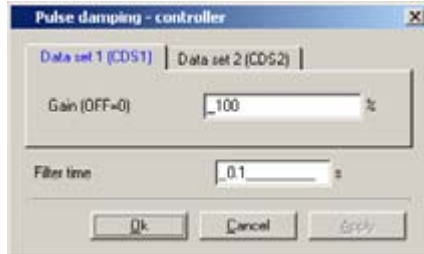

Fig. 8.7 Function mask "Vibration damping controller"

DRIVEMANAGER	Meaning	Value range	WE	Unit	Parameter
Amplification	P-proportion of controller. Setting "0" is used to switch off the controller. (Suitable value for basic setting: 100%)	-500 ... +500	0	%	611.x_APGN ¹⁾ (_VF)
Filter time	Filter for actual current	0,1 ...10	0,1	s	612_APTF (_VF)

1) Field parameter; index "x" = 0: Data set CDS1, index "x" = 1: Data set CDS2

Table 8.10 Parameters for vibration damping controller

8.3.3 Current limit controller

Function	Effect
<ul style="list-style-type: none"> The drive accelerates along the set acceleration ramp. When an adjustable current limit is reached the acceleration process is decelerated in dependence on the selected function, until sufficient current reserves are available again. In stationary operation the speed is reduced, if the motor current is too high. 	<ul style="list-style-type: none"> Protection against overcurrent shut down when accelerating excessive moment of inertia. Protection against chopping of the drive. Acceleration processes with maximum dynamics along the current limit.



Fig. 8.8 Function mask "Current limit controller"

DRIVEMANAGER	Meaning	Value range	WE	Unit	Parameter
Function	Controller OFF/ON OFF: Function disabled CCWFR: see Table 8.12	OFF/CCWFR	OFF(0)		631.x_CLSL ¹⁾ (_VF)
Current limit value	see Table 8.12	0 ... 180 of the nominal device current	150	%	632.x_CLCL ¹⁾ (_VF)
Application speed	Note: In the speed range from 0 to application speed the value of the acceleration ramp RACC is reduced to 25%. With setting 0 min ⁻¹ this function is disabled.	0 ... 30.000	0	min ⁻¹	634_CLSR (_VF)
Lowering speed	If the apparent motor current is 100% of the set current limit (CLCL), the speed will be lowered to the lowering speed along the adjusted deceleration ramp.	0 ... 1000	150	min ⁻¹	633_CLSLR (_VF)
Deceleration ramp		0 ... 32000	1000	min ⁻¹ /s	635_CLRR (_VF)

1) Field parameter; index "x" = 0: Data set CDS1, index "x" = 1: Data set CDS2

Table 8.11 Parameters for setting the current limit controller

Status	Function
Accelerations with activated current limit controller	<p>During the acceleration process with acceleration ramp (RACC) the acceleration (RACC) is reduced in a linear way from the the set value to 0 rpm/s, when 75% of the current limit is reached. This means that the drive is no longer accelerated when the current limit is reached.</p> <p>If the current limit is exceeded, the speed setpoint will be reduced. This reduction takes place with the steepness of the deceleration ramp (CLRR). This steepness increases linear from 0 to the preset value CLRR at current limit 125% CLCL. This process only takes place in the range of the lowering speed (CLSLR).</p> <p>If the apparent current of the motor drops below the current limit, the drive will again be accelerated along the acceleration ramp (RACC). The conditions mentioned before do thereby apply.</p>
Stationary operation with active current limit control	<p>The controller is still active after the acceleration process.</p> <p>If the motor load, and thus the current, increases during stationary operation, the speed will be reduced when the motor current exceeds the current limit. The motor speed is reduced along the deceleration ramp (CLRR) down to the maximum lowering speed CLSLR.</p>
Deceleration with active current limit control	<p>The current control has no effect on the deceleration ramp. I.e. the speed ramp does not change if the motor current exceeds the current limit.</p>

Table 8.12 Behaviour of the current limit controller at CLSL=CCWFR

8.3.4 DC-holding current controller

Function	Effect
<ul style="list-style-type: none"> After the deceleration ramp (RDEC) an adjustable direct current is injected into the motor. 	<ul style="list-style-type: none"> This counteracts a rotation of the motor shaft without load. No stall torque is applied against a loaded motor shaft.



Fig. 8.9 Function mask DC holding current controller

DRIVEMANAGER	Meaning	Value range	WE	Unit	Parameter
DC holding current	DC holding current related to the rated current of the drive controller	0 ... 180	50	%	608_HODCN (_VF)
Holding time	The output stage will be shut off after the set time has run out. With setting "0" the controller is switched off. (Suitable value for basic setting: 0,5 s)	0 ... 4	0	s	609_HODCT (_VF)

Table 8.13 Parameters of the DC holding current controller



Note: The function is **ineffective** in device status "Quick stop", i. e.:

- with reaction "Controller off" = "-1= acc. to reaction Quick Stop" (see chapter 6.2.3)
- when triggering quick stop via terminal (Flxx=/STOP) or field bus control bit.

8.3.5 v/f-characteristics curve



The v/f - characteristics curve is automatically adapted during initial start-up or via the motor identification. Further optimization of the motor control method VFC does not take place with the help of the v/f - characteristics curve, but via the P-controllers described in chapter 8.3.

The VFC control method has been optimized for asynchronous standard motors or asynchronous geared motors acc. to VDE 0530.

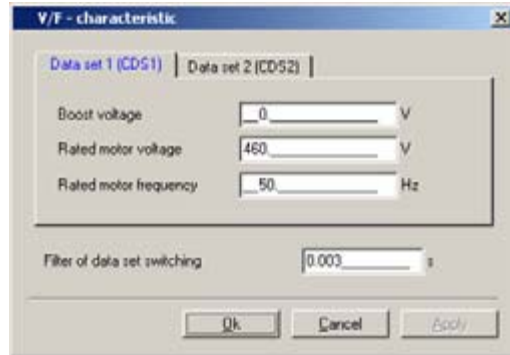

Fig. 8.10 v/f-characteristics curve

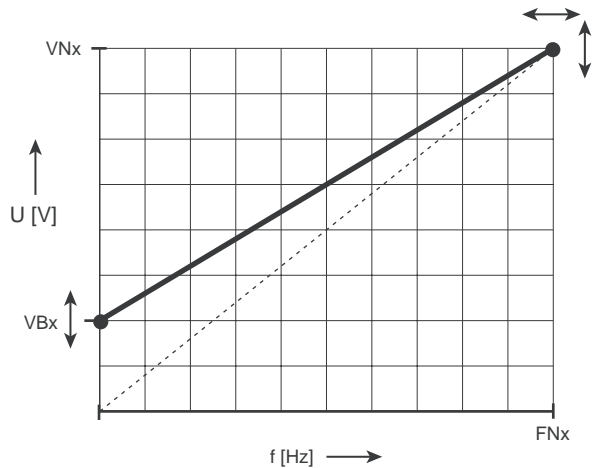

Fig. 8.11 v/f - characteristics curve with two supports

DRIVEMANAGER	Meaning	Value range	WE	Unit	Parameter
Boost voltage	Start voltage at 0 min ⁻¹ . This is automatically adapted via the start current controller.	0 ... 100	0	V	615.x_VB ¹⁾ (_VF)
Rated motor voltage	The values related to the connected motor are detected by the motor identification.	0 ... 460	460	V	616.x_VN ¹⁾ (_VF)
Rated motor frequency		0 ... 1600	50	Hz	617.x_FN ¹⁾ (_VF)
Filtering in data set changeover	When changing data sets the motor voltage is filtered to avoid sporadic changes in the transition area.	0 ... 1P	0.003	s	704_VTF (_VF)

1) Field parameter; index "x" = 0: Data set CDS1, index "x" = 1: Data set CDS2

Table 8.14 Parameters for v/f-characteristics curve

8.4 Speed control "OpenLoop" with 0-10 V or fixed speeds

Selecting the pre-set solution

This chapter describes the preset solution of speed control "OpenLoop" with 0-10V or fixed speeds. This chapter describes the inputs and outputs and the generation of setpoints.

The preset drive solution is selected via the "1st step" during initial start-up.



Fig. 8.12 Selecting the pre-set solution VSCT1

All other standard settings are made via the DRIVEMANAGER mask "Basic settings".



see chapter 6.1.3

see here in chapter - "Selection of setpoint"

see chapter 8.2.2

see chapter 8.2.3

see chapter 6.2.3

Fig. 8.13 Basic setting "Speed control "OpenLoop", 0-10 V or fixed speeds, control via terminal"

Assignment of control terminal

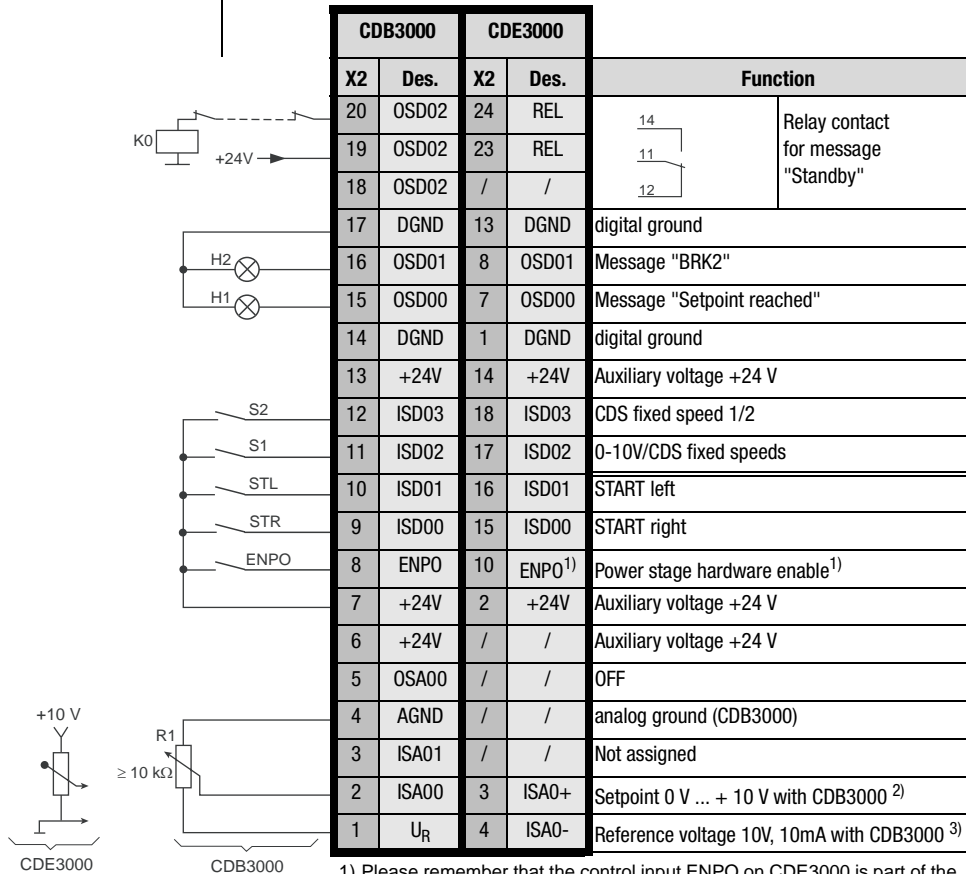

1) Please remember that the control input ENPO on CDE3000 is part of the control function "Safe Stop"

2) Analog input, differentially + at CDE3000

3) Analog input, differentially - at CDE3000

Fig. 8.14 Assignment of control terminals CDE/CDB3000

Selection of setpoint

The setpoint specification can either take place via n analog setpoint or via two fixed speeds. The logic in Table 8.15 does thereby apply.

S1 ISD02	S2 ISD03	Actual setpoint	Factory setting [min ⁻¹]
0	0	Analog input active	variable
0	1	Analog input active	variable
1	0	Changeover analog input/CDS fixed speed if S2 = 0 - fixed speed 1 if S2 = 1 - fixed speed 2	500
1	1	Changeover analog input/CDS fixed speed if S2 = 0 - fixed speed 1 if S2 = 1 - fixed speed 2	100

Table 8.15 Truth table for setpoint specification (S1, S2)

The CDS fixed speeds are set by means of a function mask.



Fig. 8.15 Function mask CDS fixed speeds

DRIVEMANAGER	Meaning	Value range	WE	Unit	Parameter
Fixed speed 1	Fixed speed at TB0 = 0	-32764 ... 32764	500	min ⁻¹	613.0_RCDS1 ¹⁾ 614.0_RCDS2 ²⁾ (_VF)
Fixed speed 2	Fixed speed at TB0 = 1	-32764 ... 32764	100	min ⁻¹	613.1_RCDS1 ¹⁾ 614.1_RCDS2 ²⁾ (_VF)

1) Parameter for data set CDS1
2) Parameter for data set CDS2

Table 8.16 Parameters CDS fixed speeds

8.5 Speed control "OpenLoop" with setpoint and control via field bus

With the preset solutions VSCC1 and VSCB1 the field bus is preset as setpoint source.

The reference value specification for the speed control is either accomplished via the device internal CAN_{open} field bus interface (VSCC1), or via the Profibus communication module (VSCB1).



see chapter 8.2.2

see chapter 8.2.3

see chapter 6.2.3

Fig. 8.16 Basic setting "Speed control "OpenLoop", setpoint and control via bus"

Assignment of control terminal

All inputs and outputs are set to 0-OFF. They can be set as described in chapter 6.1 "Inputs and outputs".

CAN_{open}

The drive controllers are integrated into the automation network via the device internal electrically isolated CAN_{open} interface X5.

Communication takes place in accordance with profile DS301. Control and target position specification is in accordance with the proprietary EasyDrive profile "Basic".

Detailed information on configuration of the drive controller in the network can be found in the separate documentation "CAN_{open} data transfer protocol".

Profibus

The speed specification and control via Profibus requires the external communication module CM-DPV1.

Control and speed specification is in accordance with the EasyDrive profile "Basic".

Detailed information on configuration of the drive controller in a network can be found in the separate documentation "Profibus data transfer protocol".

Appendix A

A.1	Overview of all error messages	A-2
-----	--------------------------------------	-----

A.1 Overview of all error messages

The error messages are divided into error including error number and fault location. Detailed explanations on error history and reactions can be found in chapter 6.9.1

Error-No.	Error	Fault location	Description
1	E-CPU	Hardware or software error	
		0	Unidentifiable error in control print
		6	Error in self-test: Parameter initialization failed due to incorrect parameter description.
		10	Insufficient RAM area for Scope function
		16	Error in program data memory (detected during run time)
		17	Error in program data memory (detected when starting device)
2	OFF	Mains failure	
		1	D.C. link direct voltage < 212 V / 425 V (is also displayed with normal mains off)
3	E-OC	Overcurrent cut-off	
		0	Overcurrent due to: 1. Incorrectly set parameters 2. Short circuit, earth leakage or insulation faults 3. Device internal defect
		1	Ixt-shut-down below 5 Hz (quick Ixt) to protect the output stage (permissible current-time area exceeded) reported by self status monitoring
		43	Output stage protection has tripped The max. permitted motor current was exceeded in dependence on the ZK-voltage and the heat sink temperature
		46	Overcurrent shut-down after wiring test Short circuit, earth leakage or insulation faults detected
		48	Overcurrent detected: 1. Incorrectly set parameters 2. Short circuit, earth leak or insulation fault in operation 3. Device internal defect
		49	Overcurrent detected 1. Incorrectly set parameters 2. Short circuit, earth leak or insulation fault in operation 3. Device internal defect
		50	Internal fault in overcurrent monitoring

Error-No.	Error	Fault location	Description
4	E-OV		Overvoltage cut-off
		1	Overvoltage caused by 1. Overload of brake chopper (too long or too many brake operations) 2. Mains overvoltage
5	E-OLM		Ixl-motor cut-off
		47	Ixt-shut-down to protect the motors (Permissible current-time area exceeded)
6	E-OLI		Ixt-converter cut-off
		48	i ² xt-shut-down to protect the output stage (permissible current-time area exceeded)
7	E-OTM		Motor overtemperature
		47	Motor overtemperature (temperature sensor in motor has responded) due to: 1. Temperature sensor not connected or incorrectly parameterized 2. Motor overloaded
8	E-OTI		Drive unit overtemperature
		44	Output stage (heat sink) overheated due to: 1. Too high ambient temperature 2. Too high load (output stage or brake chopper)
		45	Overtemperature inside the device caused by 1. Too high ambient temperature 2. Too high load (output stage or brake chopper)

Error-No.	Error	Fault location	Description
9	E-PLS		Plausibility error with parameter or program sequence
		0	Unidentifiable runtime error
		4	Unknown switching frequency or unknown device type detected
		6	The parameter list could not be initialized in the device start list. Possibly incorrect table with device class parameters.
		7	Runtime monitoring detected invalid parameter object (incorrect data type or incorrect data width)
		8	The current operation level does not contain a readable parameter, or parameter access error via KP200
		11	Runtime monitoring detected invalid length of the automatically saved memory area.
		12	Runtime error when activating an assistance parameter
		13	Unidentifiable parameter access level
		42	An exception message (Exception) was triggered.
		54	Runtime error when checking an assistance parameter
		100	Internal parameter access error during controller initialization
		101	Unknown switching frequency during initialization of the PWM
		130	Error in current controller tuning
		133	Error in performance of Macro-State-Machine
255	Userstack exceeded the maximum size		

Error-No.	Error	Fault location	Description
10	E-PAR		Parameterization error
		0	Invalid parameter setting
		5	After the device boot phase the value of a parameter is outside the valid range.
		6	Fault when initially initializing the parameter list. A parameter could not be reset to default.
		7	Error when initializing a parameter with its saved setting.
		8	Error during internal parameter access via KP200. A parameter could not be read or written.
		47	Error when initializing the motor protection module
		55	Internal error in status machine control
		100	Error in controller initialization
		101	Error when initializing the modulation
		102	Error when initializing the brake chopper
		103	Error when initializing the current model
		104	Error when initializing the current control
		105	Error when initializing the speed calculation
		106	Error when initializing the speed controller
		107	Error when initializing the torque calculation
		108	Error when initializing the position detection
		109	Error when initializing the position controller
		110	Error when initializing the V/f-characteristic control
111	Error when initializing current controlled operation		
112	Error when initializing the flow control in field weakening range		
113	Error when initializing the mains failure support		
114	Error when initializing the current and voltage detection		
115	Error when initializing the TTL encoder evaluation, lines per revolution or transmission ratio are not supported		
116	Error when initializing the HTL encoder evaluation, lines per revolution or transmission ratio are not supported		
117	Error when initializing the SSI-interface and encoder evaluation, lines per revolution or transmission ratio are not supported.		

Error-No.	Error	Fault location	Description
10	E-PAR	Parameterization error	
		118	Error when initializing the encoder function prohibited combination of encoders (e.g. a transducer is used as encoder and reference encoder)
		119	Error when initializing the control Invalid values for main inductance (zero or negative)
		120	Error when initializing the analog output
		121	Error when initializing the analog inputs
		122	Error when initializing the resolver evaluation
		123	Error when initializing the fault voltage compensation
		124	Error when initializing the speed control without sensor (SFC)
		125	Error when initializing the speed control without sensor (U/I-model)
		126	Error when initializing the external AD-converters
		127	The desired method for commutation finding is not supported.
		128	Error when initializing the GPOC error correction method
		129	Error in configuration of HTL encoder. HTL-encoder was parameterized as position-speed or reference encoder, but the input terminals FIS02 and FIS02 are not set to HTL-evaluation.
		130	Error in current controller tuning
		131	Error in self-setting (test signal generator)
132	Error in UZK-calibration		
133	Error in performance of Macro-State-Machine		
11	E-FLT	Floating point error	
		0	General error in floating point calculation
12	E-PWR	Unknown power circuitry	
		4	Power section not correctly detected
		6	Power section not correctly detected
13	E-EXT	external error message (input)	
		1	Error message from an external device is present
15	E-OPT	Error on module in options module location	
		26	BUSOFF
		27	Unable to send Transmit Protocol
		28	Guarding error
		29	Node-Error
		30	Initialization error

Error-No.	Error	Fault location	Description
16	E-CAN	CAN bus error	
		0	CAN bus error
		31	BUSOFF detected
		32	Unable to send Transmit Telegram
		33	Guarding error
		34	Node-Error
		35	Initialization error
		36	PDO object outside value range
		37	Error in initialization of communication parameters
		38	Target position memory - overflow
		39	Heartbeat - Error
		40	invalid CAN-address
		41	Insufficient memory to save communication objects
		42	Guarding error in monitoring of a Sync/PDO object
17	E-PLC	Error in processing of PLC sequential program	
		0	Error in sequencing control (PLC)
		210	Error triggered through PLC (SET ERR = 1, Mxxx with Mxxx = 1)
		211	Error in sub-program invocation / return with CALL / RET. Stack underflow: unexpected RET without previous CALL- invocation. Stack overflow: max. nesting depth (250 CALL - invocations) reached
212	Error when writing parameters (buffer full) Writing from the interrupt takes place via a buffer for max.30 entries, whereby the buffer itself is processed in the main loop. If this message occurs, the buffer capacity has been reached, i.e. the main loop was unable to process all assigned parameters.		
	The command WAIT PAR has the effect, that the program processing is stopped, until all parameters have been written and the buffer has been emptied. With a high number of parameter access operations (more than 30 successive parameter assignments) or when assuring the parameter write access during the further processing of the program, a WAIT PAR should be inserted.		
213	Error when writing parameters. Parameter does not exist, is no field parameter. Value range violation, value cannot be written, etc.		

Error-No.	Error	Fault location	Description
		214	Error when reading parameters. Parameter does not exist or is no field parameter.
		215	Internal error: No code available or program instruction cannot be executed.
		216	Internal error: No code available, program instruction cannot be executed or jump to next unused address. This error occurs when a sequential program is loaded while a sequential program is still active in the controller, whereby the new program has different line numbers. If not absolutely necessary, you should switch off the PLC when loading a program.
		217	During a division operation in the program a division by zero has occurred.
		220	Error in floating point operation in sequencing control. The sequencing control is in wait state and shows the faulty program line. Check the cancellation conditions (value ranges) for floating point operations. If necessary correct the sequencing program or the faulty program line. Note: In floating point calculations value range violations (0...3.37E+38) can occur. When comparing two floating point variables the cancellation condition may probably not be reached. Make sure to use unambiguous and plausible value ranges in programming.
		221	The cycle time of the sequencing control has been exceeded, i.e. the processing of the program takes more time than permitted.
		223	Error in indexed addressing, e.g. SET H000 = H[C01]
18	E-SIO		Error in serial interface
		9	Watchdog for monitoring of communication via LustBus has tripped.
19	E-EEP		Faulty EEPROM
		0	Error when accessing the parameter ROM
		2	Error when writing to the parameter ROM
		4	Error when reading the parameter ROM in the device boot phase
		7	Error when writing a String parameter to the parameter ROM
		11	Checksum error when initializing the AutoSave parameters
		15	Checksum error when initializing the device setting
20	E-WBK		Open circuit at current input 4-20 mA
		1	Wire breakage at current input 4 to 20mA detected
		127	Phase failure on motor detected

Error-No.	Error	Fault location	Description
30	E-ENC		Error in rotary position transducer interface
		0	Error in encoder interface
		1	Error in encoder interface: Wire breakage in track signals detected
		117	Initialization of SSI-interface
		127	Error in commutation finding The commutation angle has not been determined accurately enough.
		137	Wire breakage SSI encoder
32	E-FLW		Servo lag
		240	Servo lag
33	E-SWL		Software limit switch evaluation has responded.
		0	Error in internal setpoint limitation
		243	Positive software limit switch has responded.
		244	Positive software limit switch has responded.
		246	Internal setpoint limitation Travel set rejected by the contacted hardware or software limit switch due to a limitation of the travel range.
36	E-POS		Positioning error
		0	Error in positioning and sequencing control
		241	Error of hardware limit switch detected during referencing or no reference cam found
		242	Error of hardware limit switch interchanged during referencing.
		245	No reference point defined
		247	Timeout reached at target position
		248	Feed release missing (technology not ready, feed release missing (HALT active), quick stop active)
		249	Positioning currently not permitted (referencing active, step mode active, positioning inactive)
		250	Initialization of standardization block: the total transmission ratio (numerator/denominator) can no longer be displayed in 16 bit.
		251	Standardization: the standardized position can no longer be displayed in 32-bit.
38	E-HW		Hardware limit switched has been approached
		51	Left hardware limit switched has been contacted
		52	Right hardware limit switched has been contacted

Error- No.	Error	Fault location	Description
39	E-HWE	Hardware limit switched mixed up	
		1	Hardware limit switched mixed up negative setpoint for positive limit switch or positive setpoint for negative limit switch
41	E-PER		
		4	Internal error in CPU periphery.

Appendix B Index

A

Action register	6-106
Active characteristic curve data set display	8-5
Actual value	4-5
Adaptation of the application	
data set	3-14
Adjustment in minimized view	3-5
Amplification	6-66
analog input, options	6-27
Angular synchronism	7-36
Automation network	
Integration	4-9, 8-22
Auto-Start	6-55
Axis status	7-40

B

Bar graph, KP200-XL	6-114
Basic function with reset	6-60
Breakpoints	7-11
Bus systems	6-100

C

Calculation	
Current limit values with adapted motor protection	
characteristic	6-89
Switch-off point of the lxt-monitoring	6-89
Calling up the	

travel set table	5-41
CANopen	4-9, 6-100, 8-22
Changing the operation level	3-2, 3-3
Changing the password for an operation level ..	3-3
Chopping protection	8-14
Circulation length	5-11
CM-ProfibusDPV1	4-10, 8-22
Commissioning	3-14
Concentricity	6-62
Conditional jump instructions	7-17
Connection an start	3-4
Connection via RS232 interface cable	3-4
Control and display elements	3-10
KP200-XL	3-10
Control location	4-2, 6-55, 8-2
Drive controller	4-2, 5-2, 8-2
OPTN	6-57
PLC	4-10, 5-41
Serial interface	6-57
Control location selector	
Settings	6-56
Control off	6-38
Control terminal designation	2-9
Controller initialization	6-35
Current-time value	6-83

D

Danger (symbols)	0-2
Dangers	1-1
Dead band function with bipolar operation	6-25
Deceleration ramp	6-37
Device data	6-118
Device protection	2-18
Digital output with setting "Setpoint reached" .	6-21
Direction optimization	5-11
Display	

650-CDSAC	8-5
DS301	4-9, 8-22
DSP402	4-9
Dynamics, maximum	8-14

E

EasyDrive profile	4-10, 8-22
Einstellung	
digitale Ausgänge für BRK2	6-93
Electronic transmission	6-45, 7-36
EMC (Electromagnetic Compatibility)	1-2
Emergency Stop facility	1-4
Encoder	6-74
Encoder for CDB3000	6-75
Encoder for CDE3000/CDF3000	6-78
Encoder combination	6-76, 6-79
Encoder offset	6-80
Error	
Reactions	6-40
reset	6-127
error history	6-125
Error log	6-125
Error messages	2-15, 6-124
Error reactions	6-127, 6-129
Error stop ramp	6-40
Event control, TxPDO	6-101
Example	
Setting F1 motor potentiometer function ..	6-60
Exponential representation in the KP200 display	3-13
Exponential value as "Decimal point displacement factor"	3-13

F

Factory setting	2-16
Feed constant	5-7
Feed enable	4-8, 5-30
field oriented control	6-62
Fixed speed	
Selection	4-8
Flag	6-106
Flußaufbauphase	
Motor	6-94
Following axis	6-40
Follow-up order	5-34

activation	5-35
defined delay time	5-35
Effect of start condition	5-35
in dependence on the mode	5-33
Priority	5-34
Signal for activation	5-35
Start condition	5-34
Target position	5-35
WSTP	5-35
Frequency response analysis	6-72
Function	
BRK2	6-98
Function areas	
Parameters for characteristic curve data set	8-4
Function block	
Adaptation of digital outputs	6-13
Adaptation of the analog output	6-30
Function of motor contactor control	6-22
Function selector	6-7
digital outputs	6-15
Functions	
the most important ones	3-14
Funktion	
BRK2	6-94

G

Gear factor	5-7
Guide through this manual	0-1

H

Hardware release	6-23
Hexadecimal representation of	
warning messages	6-131
Holding brake	6-90
Speed range	6-91
HTL reference encoder	
input	6-40
Hysteresis	6-97, 6-132

I

I2xt-monitoring	6-83, 6-85
Inputs	
analog	6-25
digital	6-4

of positioning controllers	6-3
Terminal extension module UM-8140	6-5
virtual	6-6
Inputs and outputs	
Assignment	4-2, 8-2
Installation	
Connecting the KeyPad	3-9
Integral-action time	6-66
Interference suppression	6-28

J

Jerk limitation	4-3, 8-5
Jitter effects	6-110
Jog mode	5-26
Jump in reference value	4-5

K

KeyPad KP200-XL, operation	3-9
----------------------------------	-----

L

Leading axis	6-40
Light emitting diodes	2-15
Limit switch	5-25
Hardware	5-26
Software	5-25
Limit switch evaluation	6-10
Limit values	
Travel set	5-9
Limitation	4-5, 6-35, 8-8
Rotary speed	8-8
rotary speed	6-35
Torque	8-8
torque	6-35
Loading device software	2-17
Low voltage directive	1-3

M

Manual operation	5-26
Master-Slave operation	6-40
Measures for your safety	1-1
Menu level	3-11
Menu structure	3-10
KeyPad at a glance	3-12

KP200-XL, overview	3-10
Mode	5-32
Moment of inertia	6-70
of the system	6-65
reduction	6-65
Moments of inertia	6-70
Motor	
selection	6-68
type designation	6-70
Motor contactor control	6-22
Motor control	
control location	6-55
Motor data	6-67
Motor database	6-68
Motor holding brake	6-90
BRK1	6-91
Time diagram	6-98
Motor identification	6-69
Motor potentiometer function	6-58
Motor power contactor	6-22
Motor protection	6-83
Motor protection characteristic	
Factory setting	6-86
Setting	6-87
Motor shaft	5-7
Motor temperature monitoring	6-83
Motorhaltebremse BRK2	6-93, 6-96
movement tasks	4-2, 8-2

N

Nominal motor data	6-69
--------------------------	------

O

Operation and data structure	3-1
Operation levels in the parameter structure	3-2
Operation levels, parameter structure	3-2
Operation panel KP200-XL	6-57
Optional board slot	6-57
Output shaft	5-7
Output, analog	6-30
Outputs	
digital	6-13
Terminal extension module UM-8140	6-14

virtual	6-15
Outputs of positioning controllers	6-3
Overcurrent protection	8-14
Override	5-10

P

Parameter	
Characteristic curve changeover	8-4
Characteristic curve data set changeover ...	8-4
Device data	6-118
Motor holding brake	6-92
Motor potentiometer function	6-59
Subject area _51ER Error messages	6-126
parameter datasets	4-2, 8-2
Parameters	
digital outputs	6-15
Setpoint structure	6-54
Path optimized positioning of a round table	7-38
Permanent actual value display, KP200-XL ...	6-114
Pictograms	0-2
Pin assignment of the serial interface X4, CDE	2-13
PLC	
Command syntax	7-10
Control parameters	7-43
Line renumbering	7-7
New generation of program	7-5
PLC editor	7-4
PLC program structure	7-5
Program file	7-7
Program handling	7-8
Sequential program	7-6
Syntax test	7-7
Text declaration	7-5
Text declaration file	7-7
Variables and flags	7-42
Position Control	6-62
Position control	6-62
Block diagram	6-50
Position plan CDB3000	2-7
Positioning	

Pre-set solution	5-2
Possibilities of characteristic curve data set	
changeover with 651-CDSSL	8-4
Possible motor protections	6-89
Power terminal designation CDB	2-8
Pre-set solution	4-2, 8-2
Positioning	5-2
Reset	2-16
Speed control "OpenLoop"	8-2
Speed regulation	4-2
Procedure	
Commissioning	3-14
Profibus	4-10, 6-104, 8-22
Profile	5-10
Profile Velocity mode	4-9
PTC	
Evaluation	6-84

Q

Qualification, user	1-2
Quick stop	
Reactions	6-39
Quick stop ramp	5-30

R

Ramp, linear	6-34, 8-5
Ramps	
linear	4-3, 8-5
Reactance coil	6-23
Reference encoder	6-40
as speed setpoint source	6-44
Configuration HTL	6-44
Configuration TTL	6-43
Example for reference encoder configuration	6-46
in positioning operation	6-45
in speed controlled operation	6-44
Selection for CDB3000	6-42
Selection for CDE/CDF3000	6-42
Reference encoder input	
Configuration	7-36
Reference encoder input, configuration	6-40
Reference source	4-2, 8-2
Field bus	4-9
PLC	4-10

Pre-set solution	4-2, 8-2
Speed regulation	4-7
Travel set table	5-28
Reference value	
reached	4-5
Referencing	5-13, 5-15
Absolute encoder	5-16
General	5-13
Homing Mode with CANopen	5-40
start conditions	5-15
Tab	5-4
Type 1	5-17
Type 11 to 14	5-21
Type 17 to 30	5-23
Type 2	5-18
Type 3+4	5-18
Type 33 and 34	5-24
Type 35	5-24
Type -4 to type 0	5-16
Type 5+6	5-19
Type 7 to 10	5-20
Re-initialization	2-16
Relative positioning	7-38
Repairs	1-3
Repetition	5-34
Representation	
error history	6-125
Reset	
Parameters	2-16
Resetting parameter settings	2-16
Responsibility	1-4
Reversing lock	5-11
Round table configuration	5-12
Rotary speed profile generator	4-3, 6-34
Round table configuration	5-11
RS232	2-4
 S	
Safety	1-1
Sequential program	
PLC	6-57
Serial interface, as control location	6-57
Set counter	7-31
Setpoint	
generation	6-33
reached	8-7
Setpoint fluctuation	6-21
Setpoint generation	6-33
Setpoint jump	8-7
Setpoint reached	6-21
Setpoint source	
Field bus	8-22
Setpoint specification	
Block diagram	6-50
Setpoint structure	
Display parameter	6-54
Setting	
digital outputs for BRK2	6-97
Motor protection characteristic	6-87
Setting and starting timers	7-31
Setting operation levels via "_36KP-KeyPad" ...	3-2
Settings	
360-DISP and 361-BARG	6-115
651-CDSSL	8-4
Control location selector	6-56
Control location selector 260-CLSEL	6-56
Function selector for digital outputs	6-15
Inputs motor potentiometer functions	6-60
Motor potentiometer function	6-59
Motor protection characteristic	6-86
settings	
240-FOS00 ... 246-FOE03	6-15
Short circuit	2-19
Slave	6-40
Slip	6-34, 8-5
Jerk limitation	5-28
Slip time	
JTIME	4-4, 8-6
with jerk limitation	5-11
Specification	
Interface contacts	2-9
Interface contacts CDE	2-4, 2-13
Speed Control	6-62
Speed control	6-62
+/- 10V reference value	8-19
via CANopen	8-22
via Profibus	8-22
Speed limit	6-90
Speed override	5-10
Speed regulation	
+/- 10V reference value	4-6

Block diagram	6-52
via CANopen	4-9
via Profibus	4-9
with fixed speed	4-7
with PLC	4-10
with reference encoder setpoint source ...	6-44
Speed synchronism	7-36
Standardization	5-6
Standardization of actual parameter values ...	6-115
Standardization of the analog output	6-30
Standardizing with unipolar operation	6-25
Standards	1-3
Start	
flank triggered	6-55
Level triggered	6-55
Stop feed	6-38
Reactions	6-38
Stop ramp	4-5, 8-8
Switching point	5-36
Switch-off limits	2-19
Synchronism	6-40
Synchronization	6-111

T

Table of fixed speeds	4-7
Tabular travel set	
PCT_2, PCC_2, PCB_2	5-2
Target position	5-32
Teach in	5-39
Temperature sensor	6-83
Temperature sensors, types	6-84
Terminals	
as control location	6-57
Time diagram for the motor holding brake	
BRK2	6-98
Time diagram for the motor holding brake BRK2	6-94
Torque Control	6-62
Torque control	6-62
Block diagram	6-52
Torque limitation	
via analog input	6-36
via parameter	6-36
Track signal correction GPOC	6-81
Trailing distance	

permissible	5-9
Travel profile	5-9
Travel set	
Display and selection	4-8
Limit values	5-9
Repetition	5-34
see follow-up order	5-34
Switching points	5-36
Travel set selection	5-28
Travelling	
endless	7-36
with continuation	7-34
Truth table for	
control via terminals	6-9
TTL reference encoder input	6-40

U

Units	5-6
User defined subject area _11UA	6-112

V

Value display in exponential representation	3-13
Value ranges	5-8
View of device and terminals	2-7

W

Wait commands	7-40
Warning messages	
Hysteresis	6-132
Warning thresholds	6-132



Lust Antriebstechnik GmbH

Gewerbestraße 5-9 • 35633 Lahnau • Germany

Phone +49 (0) 64 41 / 9 66-0 • Fax +49 (0) 64 41 / 9 66-137

Internet: <http://www.lust-antriebstechnik.de> • e-mail: info@lust-tec.de



Lust DriveTronics GmbH

Hansastraße 120 • 59425 Unna • Germany

Phone +49 (0) 23 03 / 77 9-0 • Fax +49 (0) 23 03 / 77 9-3 97

Internet: <http://www.lust-drivetrronics.de> • e-mail: info@drivetrronics.de

ID no.: 1001.22B.1-00 • 06/2005

We reserve the right to make technical changes.