

Technical Manual

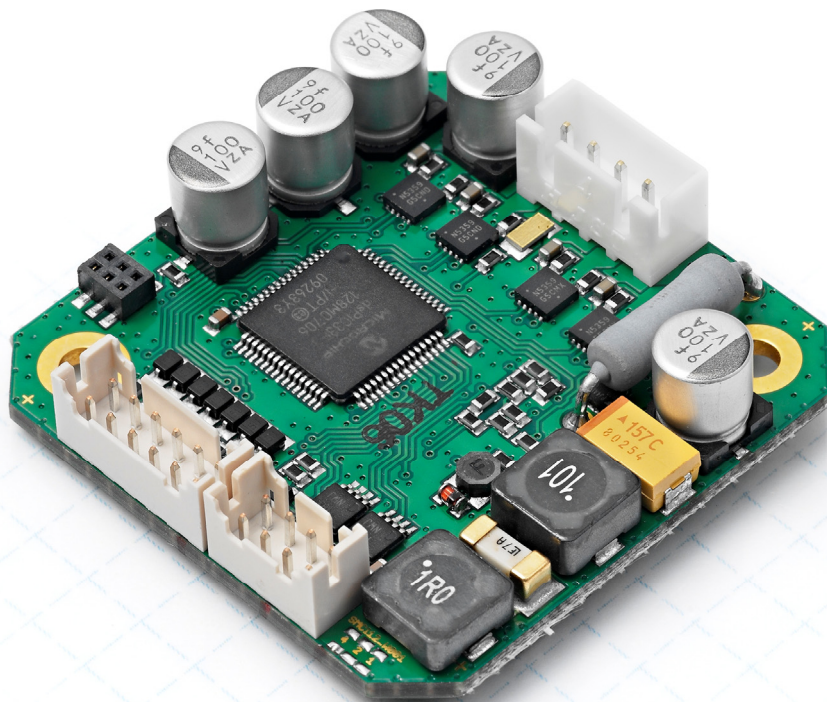

Stepper controller SMCI12

NANOTEC ELECTRONIC GmbH & Co. KG
Gewerbstraße 11
D-85652 Landsham near Munich, Germany

Tel. +49 (0)89-900 686-0
Fax +49 (0)89-900 686-50
info@nanotec.de

Editorial

© 2010

Nanotec[®] Electronic GmbH & Co. KG

Gewerbestraße 11

D-85652 Landsham / Pliening, Germany

Tel.: +49 (0)89-900 686-0

Fax: +49 (0)89-900 686-50

Internet: www.nanotec.de

All rights reserved!

MS-Windows 2000/XP/Vista are registered trademarks of Microsoft Corporation.

Version/Change overview

Version	Date	Changes
1.0	11/02/2010	New issue C+P

About this manual

Target group

This technical manual is aimed at designers and developers who need to operate a Nanotec stepper motor without much experience in stepper motor technology.

Important information

This technical manual must be carefully read before installation and commissioning of the stepper motor control.



Nanotec[®] reserves the right to make technical alterations and further develop hardware and software in the interests of its customers to improve the function of this product without prior notice.

This manual was created with due care. It is exclusively intended as a technical description of the product and as commissioning instructions. The warranty is exclusively for repair or replacement of defective equipment, according to our general terms and conditions; liability for subsequent damage or errors is excluded. The warranty is exclusively for repair or replacement of defective equipment, according to our general terms and conditions; liability for subsequent damage or errors is excluded. Applicable standards and regulations must be complied with during installation of the device.

For criticisms, proposals and suggestions for improvement, please contact the above address or send an email to: info@nanotec.com

Additional manuals

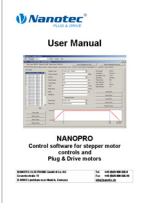
Please also note the following manuals from Nanotec:

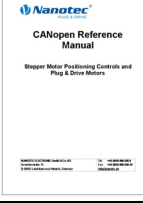
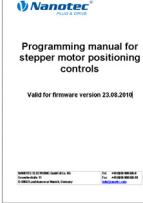
NanoPro User Manual	Configuration of controllers with the NanoPro software	
NanoCAN User Manual	Configuration of the CAN communication for CANopen-capable controllers with the NanoCAN software	
Nanotec CANopen reference	Detailed documentation of the CANopen functions	
Programming manual	Controller programming <ul style="list-style-type: none"> • Command reference • NanoJ • COM interface 	

The manuals are available for download at www.nanotec.com.

Contents

1	Overview	5
2	Connection and commissioning	7
2.1	Overview	7
2.2	Connection diagram	8
2.3	Commissioning.....	9
3	Connections and circuits	12
3.1	Inputs and outputs: connector X11	12
3.2	Stepper motor connection: Connector X10.....	14
3.3	Power supply and RS485/CANopen interface: Connector X12.....	15
3.3.1	Pin assignment.....	15
3.3.2	Power supply connection	15
3.3.3	RS485 network/CANopen interface	16
4	Operating modes.....	18
4.1	Serial operating modes	18
4.2	CANopen operating modes.....	20
5	Troubleshooting.....	21
6	Technical data	23
	Index.....	25

1 Overview

Introduction

The stepper motor control SMCI12 is an extremely compact and cost-effective constant current power output stage with integrated Closed-Loop current control.

Due to the great capacity and functions available, it offers designers and developers a rapid and simple method of resolving numerous drive requirements with less programming effort.

It is used for controlling standard stepper motors. BLDC motors are not supported.

Variants

The stepper motor control is available in the following variants:

- SMCI12: For control via RS485
- SMCI12-3: For control via CANopen

Unless otherwise specified, the term "SMCI12" is used for both variants in this manual.

SMCI12 functions

The stepper motor control SMCI12 contains the following functions:

- Microstep -1/1 – 1/64 final output stage (step resolution of up to 0.014° in motors with a step angle of 0.9° in 1/64 step mode)
- Powerful DSP microprocessor for flexible I/O
- RS485/CANopen interface for parameterization and control
- Application program with NanoJ (SMCI12 with RS485)
- Network capability with up to 254 motors (SMCI12) or 127 motors (SMCI12-3)
- Easy programming with Windows software NanoPro (SMCI12) or NanoCAN (SMCI12-3)

dspDrive[®]

With dspDrive[®], the motor current is controlled directly by a digital signal processor. Unlike conventional ICs, which resolve the winding current measurement and the target current value with only 6 or 8 bit, the new dspDrive[®] performs the entire control with a resolution of 12 bit. The parameters of the PI current controller can be adjusted to the motor and by the user as a function of the rpm.

This has the following application advantages:

- Very smooth, low-resonance operation with a sinusoidal current in the windings, even at low speeds.
- Very good step angle accuracy and synchronization, even in open-loop operation.

NanoJ

The integrated programming language NanoJ, based on the Java standard, means complete application programs can be realized on the drivers that can be executed independently without a higher-order controller.

The programs can be created, compiled directly and written to the controller with the free NanoJEasy editor.

NanoJ is only supported by the RS485 firmware.

More detailed information can be found in the separate programming manual.

Settings

The operating behavior of the motor can be set and optimized according to individual requirements by setting the motor-related parameters. The parameters can be set using the NanoPro software and significantly reduce commissioning time.

More detailed information on this can be found in the separate NanoPro user manual.

2 Connection and commissioning

2.1 Overview

Plug connections

The controller has the following connectors:

X10 (JST-XH): stepper motor connection

X11 (JST-PHD): inputs and outputs

X12 (JST-PHD): power supply and interface RS485 or CANopen

Configuration

The following figure shows the configuration of the connectors on the printed circuit board.

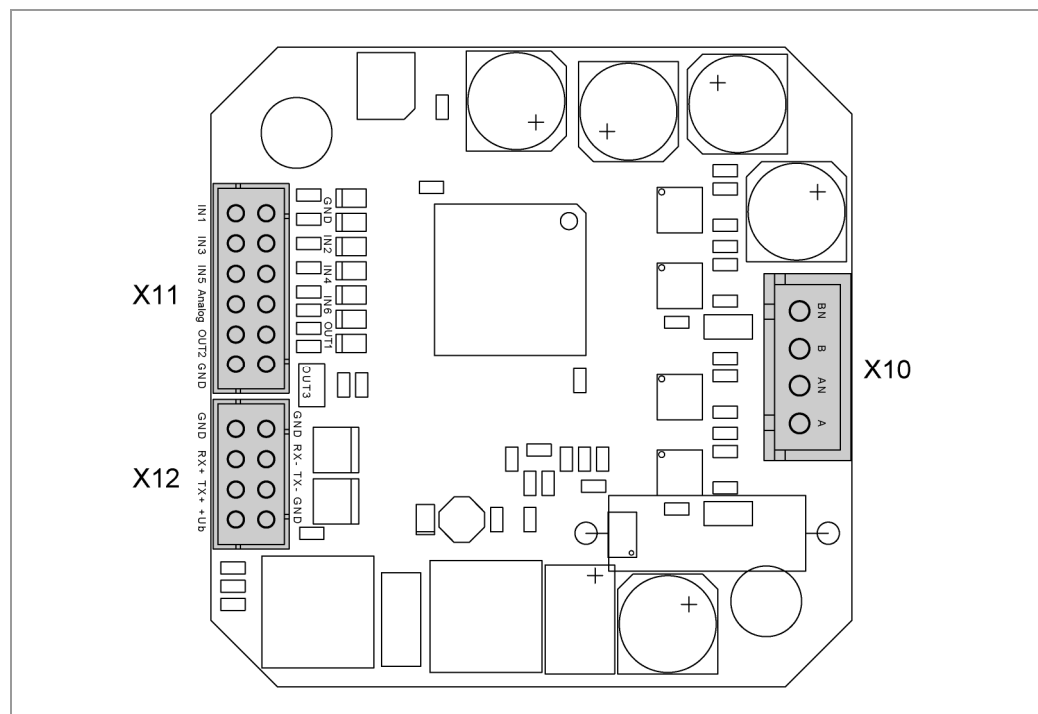

2.2 Connection diagram

To operate a stepper motor with the SMC112 stepper motor control, the wiring must be implemented according to the following connection diagram.

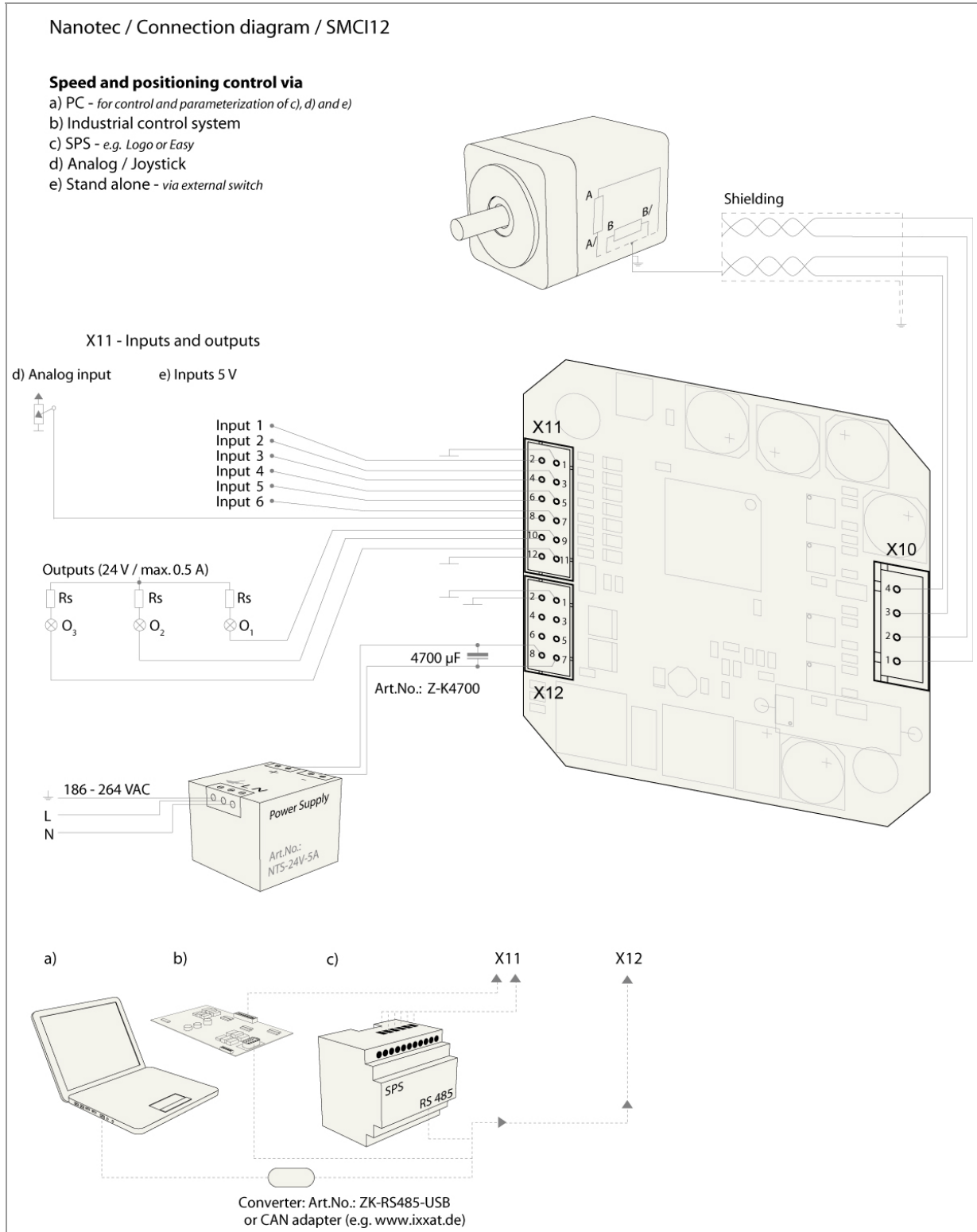

2.3 Commissioning

Introduction

The connection and commissioning of the SMCI12 stepper motor are described below.

This section describes the main first steps you need to take to be able to quickly begin working with the SMCI12 if you are using the NanoPro (SMCI12) or NanoCAN (SMCI12-3) software from a PC. You will find more detailed information in the separate NanoPro and NanoCAN manuals.



If you want to work with a PLC or your own program later, you will find the necessary information in the separate programming manual.

Familiarize yourself with the SMCI12 stepper motor control and the corresponding NanoPro or NanoCAN control software before you configure the controller for your application.

Commissioning with NanoPro (SMCI12 with RS485 firmware)

Proceed as follows to commission the controller with the RS485 firmware:

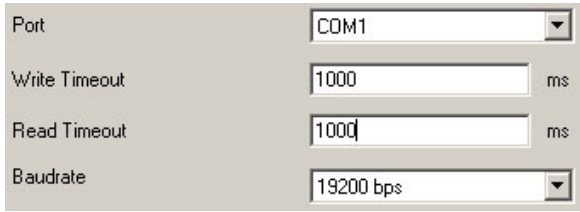
Step	Action	Note
1	Install the NanoPro control software on your PC. See the NanoPro separate manual.	Download of www.nanotec.com
2	Connect the controller to the stepper motor according to the connection diagram.	Connection diagram, see Section 2.2. Detailed information on connections can be found in Chapter 3.
3	Switch on the operating voltage (12-24 V DC).	
4	If necessary, install the driver for the converter cable ZK-RS485-USB.	Download www.nanotec.com in the Accessories/Converter menu item
5	Connect the controller to the USB port of your PC. Use the converter cable ZK-RS485 and the cable set ZK-SMCI12.	Order identifier: <ul style="list-style-type: none"> • ZK-RS485-USB • ZK-SMCI12
6	Start the NanoPro software.	The NanoPro main menu appears.
7	Select the <Communication> tab.	

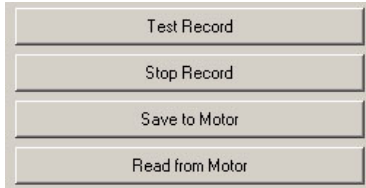
Step	Action	Note
8	<p>In the "Port" field, select the COM port to which the SMCI12 is connected.</p> 	The number of the COM port to which the controller is connected can be found in the device manager of your Windows PC (System Control/System/Hardware).
9	Select the "115200 bps" entry in the "Baudrate" selection field.	
10	Check the current setting using the motor data sheet.	Under no circumstances may the current be set to a value higher than the rated current of the motor.
11	Select the <Movement Mode> tab. 	
12	Click on the <Test Record> button to carry out the pre-set travel profile. 	The connected motor operates with the pre-set travel profile (default travel profile after new installation).
13	You can now enter your required settings. For instance, you can enter a new travel profile.	See the NanoPro separate manual.

Commissioning with NanoCAN (SMC112-3 with CANopen firmware)

Proceed as follows to commission the controller with the CANopen firmware. More detailed information can be found in the separate NanoCAN manual.

Step	Action	Note
1	Install the NanoCAN control software on your PC.	Download of www.nanotec.com
2	Connect the controller to the stepper motor according to the connection diagram.	Connection diagram, see Section 2.2. Detailed information on connections can be found in Chapter 3.
3	Switch on the operating voltage (12-24 V DC).	
4	Install and configure your CANopen adapter.	Details can be obtained from the manufacturer of the CANopen adapter.
5	Start the NanoCAN software.	
6	Select the desired node ID, the baud rate 115200 bps and, if necessary, the CAN card in the <Configuration & NMT> tab.	
7	Select the desired operating mode (e.g. PP mode) by selecting the appropriate tab.	
8	Click on the <Power on> button.	
9	Enter the desired target position in the <target> field.	
10	Click on the <Start> button.	

3 Connections and circuits

3.1 Inputs and outputs: connector X11

Introduction

An overview of the assignments can be found in the connection diagram in Section 2.1. This section looks in detail at the assignment, functions and circuits of the connector X11.

Pin assignment

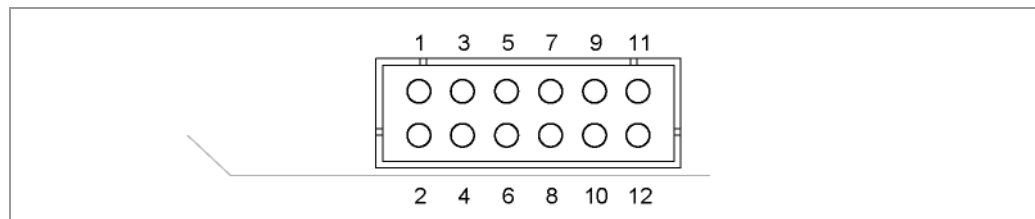

Pin no.	Name	Observations
1	GND	Mass (0 V)
2	Input 1	Digital inputs (max. 5 V)
3	Input 2	
4	Input 3	
5	Input 4	
6	Input 5	
7	Input 6	
8	Analog In	Analog input (–10 V ... +10 V)
9	Output 1	Digital outputs
10	Output 2	
11	Output 3	
12	GND	Mass (0 V)

Function of the inputs

All digital inputs – with the exception of the "Clock" input in the clock directional mode – can be freely programmed using the NanoPro software (e.g. as a limit position switch, enable, etc.) and can be used for sequential control with NanoJ.

All inputs can be configured for "active-high" (PNP) or "active-low" (NPN) with NanoPro.

Signal states at the outputs (SMC112 with RS485 firmware)

Note:

In the SMC112-3 with CANopen firmware, the status of the controller is not displayed at the outputs.

The following table shows the possible signal states at the outputs 1 to 3:

Signal states			Meaning
Output 3	Output 2	Output 1	
	0	0	Rotation monitoring (error) or limit switch
	0	1	Motor idle (waiting for new command).
	1	0	Busy (control processing last command).
	1	1	Reference point or zero point reached
1			Overtemperature

The outputs can be freely programmed using the NanoPro software.

Note:

Output 3 is also used to display errors and when switching on the controller.

Input circuits

Note:

The voltage must not exceed 5 V. It should drop below 2 V for safe switching off and be at least 4.5 V for safe switching on.

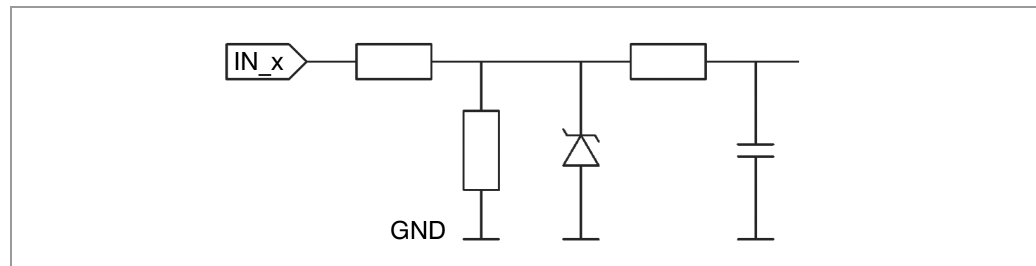

Output circuits

The outputs are transistor outputs in Open-Collector circuits (0 switching, max. 24 V/0.5 A). An LED can be integrated to test the output. The LED lights up when the output is active.

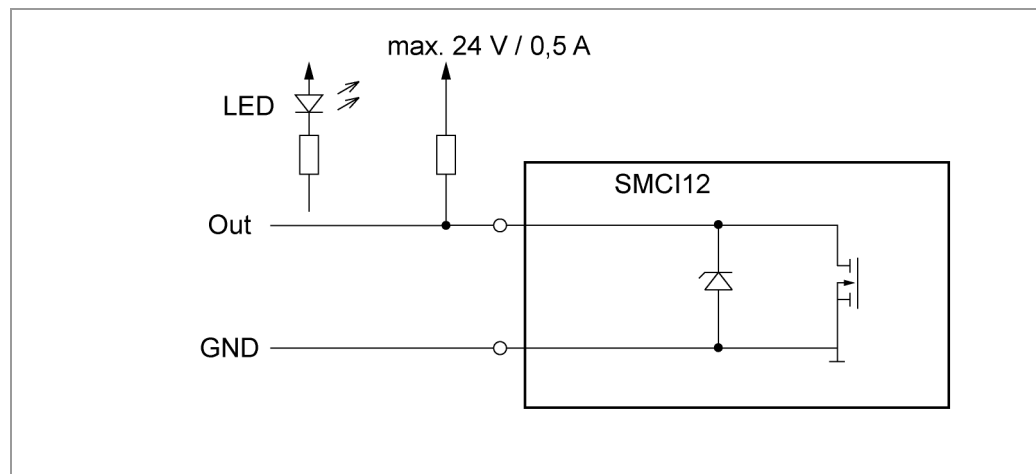

3.2 Stepper motor connection: Connector X10

General information

The motor is connected to the SMC112 with a 4-wire cable. Twisted wire pair cables with braided shields are recommended.



Danger of electrical surges

Mixing up the connections can destroy the output stage! See the data sheet of the connected stepper motor.

Never disconnect the motor when operating voltage is applied!

Never disconnect lines when live!

Pin assignment

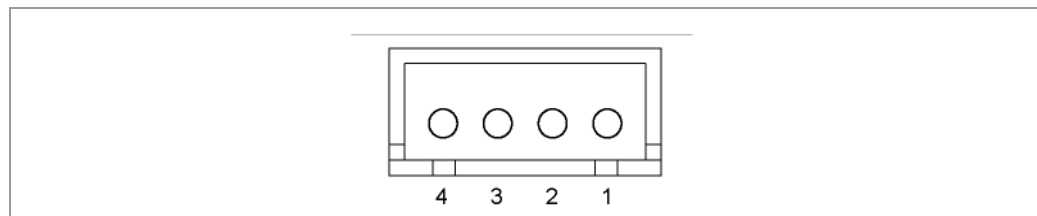

Pin no.	Name	Observations
1	A	See the data sheet of the connected stepper motor.
2	A/	
3	B	
4	B/	

Motor with 6 or 8 connections

If you are using a motor with 6 or 8 connections, you need to connect the windings.

The pin configuration for the motor can be found on the motor data sheet, which can be downloaded from www.nanotec.de.

For a simplified connection, you can also use connection cable **ZK-XHP4-300**.

Details can be found on the Nanotec website www.nanotec.com.

3.3 Power supply and RS485/CANopen interface: Connector X12

3.3.1 Pin assignment

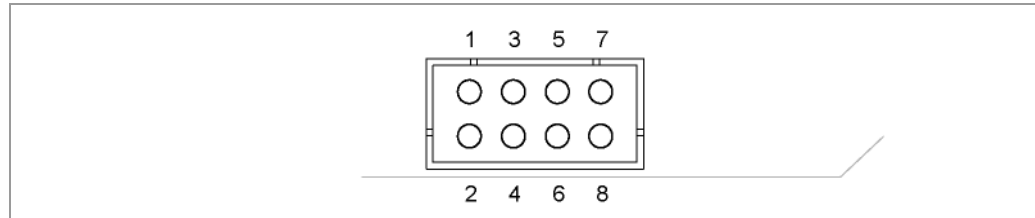

Pin no.	RS485	CANopen	Observations
1	GND	GND	Earth (0 V)
2	GND	GND	
3	Rx-	n.c.	Network interface
4	Rx+	n.c.	
5	Tx-	CAN low (CAN -)	
6	Tx+	CAN high (CAN +)	
7	GND	GND	Earth (0 V)
8	Vcc	Vcc	Operating voltage 12-24 V DC

3.3.2 Power supply connection

Permissible operating voltage

The permissible operating voltage of the stepper motor control SMCI12 lies within the range 12-24 V DC and must not exceed 26 V or undershoot 11 V.

A charging condenser with minimum 4700 µF (10000 µF) must be provided for the operating voltage to prevent exceeding the permissible operating voltage (e.g. during braking).



Danger of electrical surges

Connect charging condenser with minimum 4700 µF!

Connect a condenser with 10000 µF for motors with flange size 86x86 (series ST8918) or greater!

An operating voltage > 26 V can destroy the output stage! The ballast resistance overheats after approx. 500 ms depending on the voltage.

Mixing up the connections can destroy the output stage!

Never disconnect the motor when operating voltage is applied!

Never disconnect lines when live!

Connection diagram

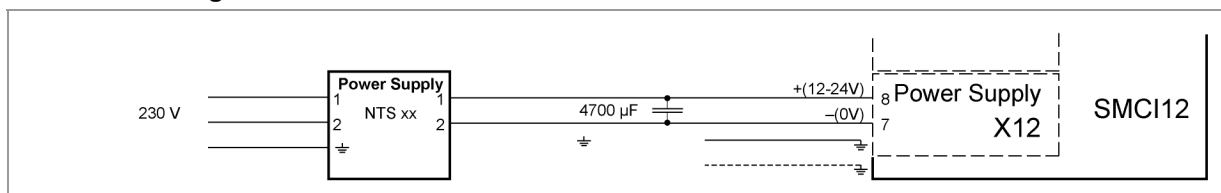

Note:
Complete connection diagram, see Section 2.1.

Accessories for voltage supply

Appropriate power packs and charging condensers are available as accessories:

Name	Order identifier
Power pack	NTS-xxV-yA (xx=voltage: 12 or 24 V, y=current: 2.5, 5 or 10 A) Information on the selection of the required power supply unit can be found in our FAQ on www.nanotec.de .
Charging condenser	Z-K4700 or Z-K10000

Note:
Further information about accessories can be found on the Nanotec website:
www.nanotec.com

3.3.3 RS485 network/CANopen interface

SMC112 in a network

Up to 254 (SMC112) or 127 (SMC112-3) stepper motor controls can be controlled in a network from a PC or PLC.

These network connections are set up via the RS485/CANopen interface.

Two-wire operation RS485

To enable RS485 two-wire transmission capability, all bus stations must have a direction control.

An intelligent converter, which automatically switches to transmission mode when a start bit is received at the RS-232 interface and returns to reception mode at the end of the stop bit, enables two-wire operation of the SMC112. This solution does not require software support.

We can recommend the ICP-7520 converter, for example, that is available from Schuricht.

Talk to our Technical Hotline if you require support for this.

Circuit diagram RS485 network

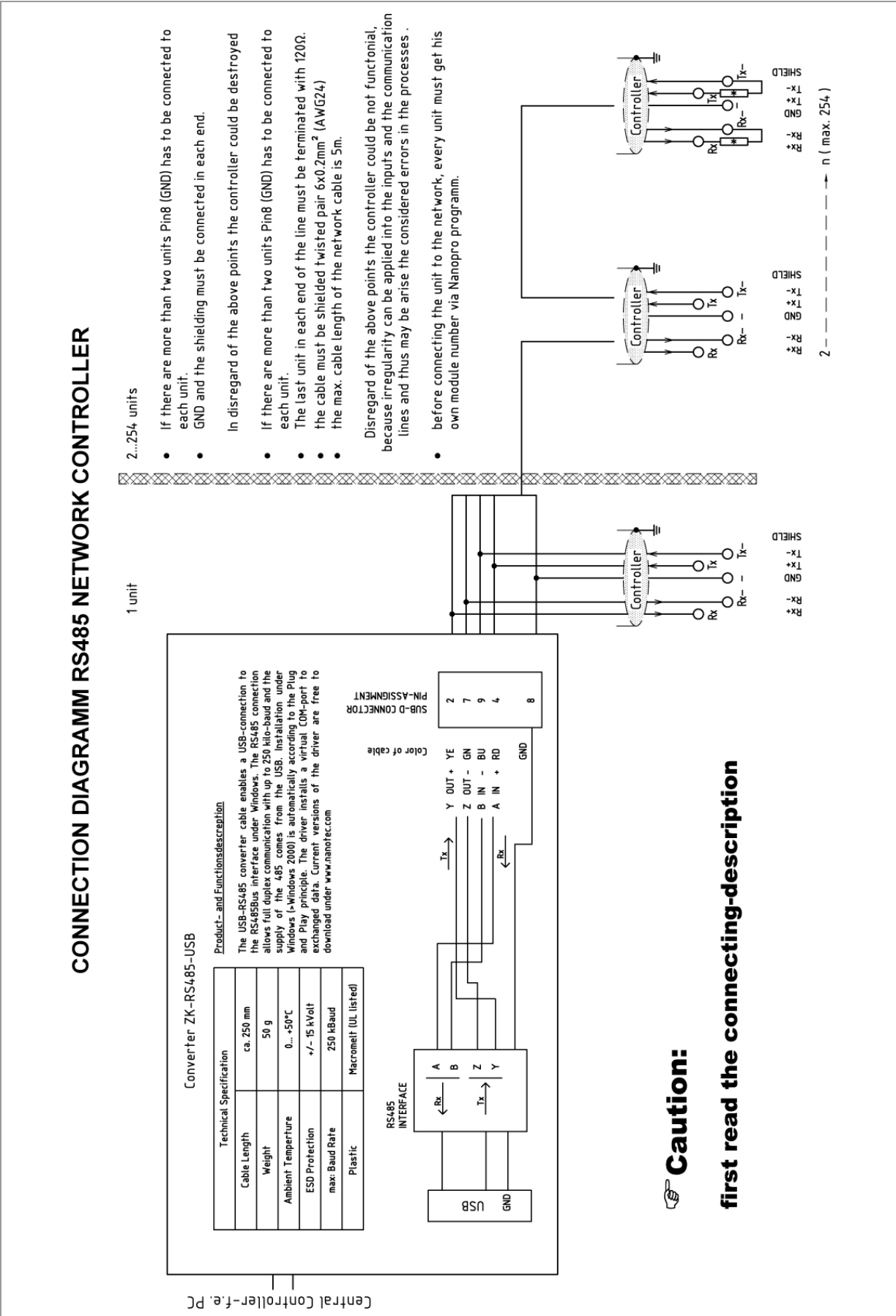

4 Operating modes

4.1 Serial operating modes

Introduction

Depending on the travel profile, the motor can be operated in serial mode using different operating modes. Due to the great capacity and functions available, it offers designers and developers a rapid and simple method of resolving numerous drive requirements with less programming effort.

Select the required operating mode for each drive profile and configure the controller according to your requirements.

More detailed information can be found in the separate NanoPro manual.

Overview of operating modes and their areas of application

Operation mode	Application
Relative positioning	Use this mode when you wish to travel to a specific position. The motor travels according to a specified drive profile from a Position A to a Position B.
Absolute positioning	
External reference run	During an external reference run, the motor travels to a switch connected to the reference input.
Speed mode	Use this mode when you wish to travel with a specific speed (e.g. a conveyor belt or pump speed). In the speed mode, the motor accelerates with a specified ramp from the starting speed (start frequency "V Start") to the specified maximum speed (maximum frequency "V Normal"). Several inputs enable the speed to be changed on-the-fly to different speeds.
Flag positioning mode	The flag positioning mode offers a combination of the speed and positioning modes. The motor is initially operated in speed mode; when a trigger point is reached, it changes to the positioning mode and the specified setpoint position (relative to the trigger position) is approached. This operating mode is used for labeling, for example: the motor first travels with the set ramp to the synchronous speed of the conveyed goods. When the labels are detected, the preset distance (position) is traveled to apply the labels.

Operation mode	Application
Clock direction mode, left/right	Use this mode when you wish to operate the motor with a superordinate controller (e.g. CNC controller).
Clock direction mode Ext. Ref.	In the clock direction mode, the motor is operated via two inputs with a clock and a direction signal from a superordinate positioning control (indexer). External reference run is supported.
Analog and joystick mode	The speed setting of the motor is performed in this operating mode simply with a potentiometer or a joystick (–10 V to +10 V). Use this mode if you want to use the motor in a simple application: <ul style="list-style-type: none"> • Setting a specific speed, e.g. via an external potentiometer, • Traveling synchronously with a superordinate controller with analog output (–10 V to +10 V).
Analogue positioning mode	Use this mode when you wish to travel to a specific position. The voltage level on the analog input is proportional to the required position.

Selecting the operating mode in NanoPro

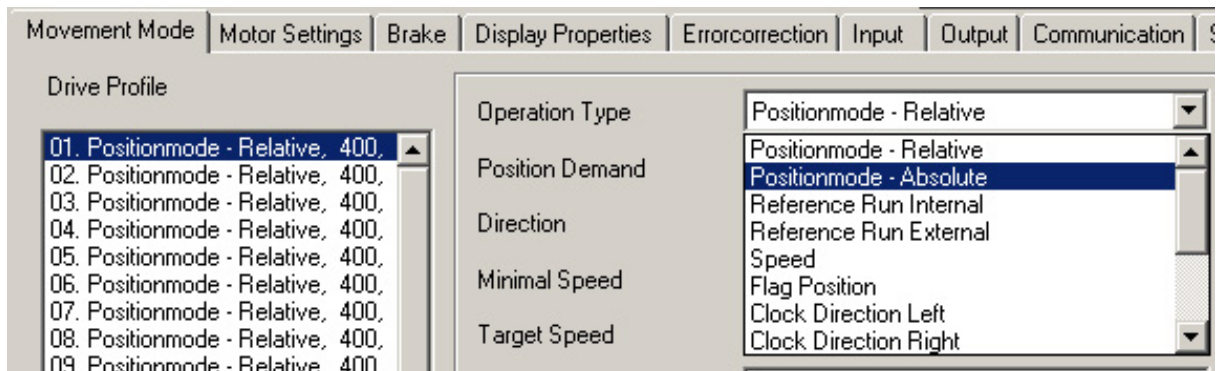

4.2 CANopen operating modes

Introduction

The motor can be operated using a total of 4 different operating modes in CANopen mode.

More detailed information can be found in the separate NanoCAN manual.

Overview of operating modes and their areas of application

Operation mode	Application
Positioning mode (PP mode)	Use this mode if you want to use the motor for positioning. The motor moves from A to B with the set parameters (ramp, speed, etc.).
Speed mode (Velocity Mode)	Use this mode when you wish to travel with a specific speed (e.g. a conveyor belt).
Reference run (Ref Mode/Homing Mode)	Use this mode to reference the motor (external/on block).
Interpolated Position Mode	Use this mode with a superordinate path control.

Selecting the operating mode in NanoCAN

When one of the following tabs – <Ref Mode>, <PP Mode>, <Velocity Mode> or <Interpolated Position Mode> – is activated, the corresponding SDO is immediately written to the control to activate the selected mode.

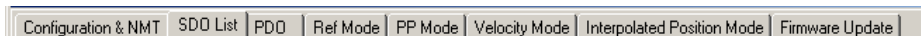

5 Troubleshooting

Troubleshooting procedure

Proceed with care during troubleshooting and error rectification to avoid damaging the controller.

	<p>Danger of electrical surges</p> <p>An operating voltage > 26 V and incorrect connections can destroy the end stage. Never disconnect the motor when operating voltage is applied! Never disconnect lines when live!</p>
---	--

Possible errors in serial mode

Error	Possible cause	Rectification
Controller is not ready	Data transmission to SMCI12 not possible (communication error): Incorrect COM port selected.	In the "Communication" tab, select the PC port to which you have connected the SMCI12 (e.g. "COM-1") The port used can be found in the device manager of your PC.
	Wrong baud rate setting.	Select the baud rate 115200 bps in the <Communication> tab.
	Communication cable not connected or interrupted (incorrect RS232-RS485 converter used).	Use the recommended RS485-USB converter from Nanotec: <ul style="list-style-type: none"> Order identifier: ZK-RS485-USB
	A non-existent motor number (module number) is set.	Set the correct module address. See the separate manual on NanoPro.
	The power supply of the SMCI12 is interrupted.	Check voltage supply, switch on if necessary.
	Another open program is blocking the COM port to which the SMCI12 is connected.	Close down other programs on your PC.
	Inadmissible data was sent to the controller during the output of a travel profile.	Click on the <Yes> button to stop the travel profile. The SMCI12 switches back to the "Ready" state. The data can then be resent to the controller.
Transmission error	Data transmission to the SMCI12 is disturbed (sender or receiver are disturbed).	Check that the motor connection is correctly wired. We recommend using the following Nanotec converters: <ul style="list-style-type: none"> ZK-RS485-USB
Position error	The motor cannot reach the position or the limit switch was overrun.	Click the <Yes> button in the error message; the error is reset.

Possible errors in CANopen mode

Error	Possible cause	Rectification
No communication with the controller	The wrong node ID has been set.	On the <Configuration & NMT> tab in NanoCAN, select the node ID that is set on the rotary switches of the controller.
	Wrong baud rate setting.	On the <Configuration & NMT> tab in NanoCAN, select the baud rate 115200 bps.
	The communication cable is not connected or is interrupted.	Check all connections, especially the terminal resistances.
Transmission error	Data transmission is disturbed (sporadically).	Switch the power supply off and on again.

6 Technical data

Electrical connections

Operating voltage V_b	DC 12-24 V \pm 4%
Max. phase current	Adjustable up to max. 2.7 A/phase Continuous current 1.8 A/phase
Current drop	Adjustable 0 to 150% of rated current
Interface	<ul style="list-style-type: none"> RS-485 (4-wire), 115200 bps (adjustable) 1 start bit, 8 data bit, 1 stop bit no parity CANopen

Controller parameters

Step resolution	Full step, half step, quarter step, fifth step, eighth step, tenth step, 16th steps, 32nd step, 64th step, adaptive microstep, feed rate
Step frequency	16 kHz with a full step, corresponding multiples with a microstep (e.g. 1 MHz with 1/64) Max. input frequency, clock direction mode (serial mode): 200 kHz

Protective circuits

Overvoltage and undervoltage	Protection circuit for voltage > 26 V or < 11 V
Max. heat sink temperature	Approx. 80 °C
Max. ambient temperature	0 to 40 °C

Inputs and outputs

Inputs	<ul style="list-style-type: none"> 6 digital inputs (TTL, max. 5 V) 1 analog input (+10 V / -10 V)
Outputs	3 MosFET outputs Open collector (0 switching, max. 24 V/0.5 A)

SMC112 dimensions

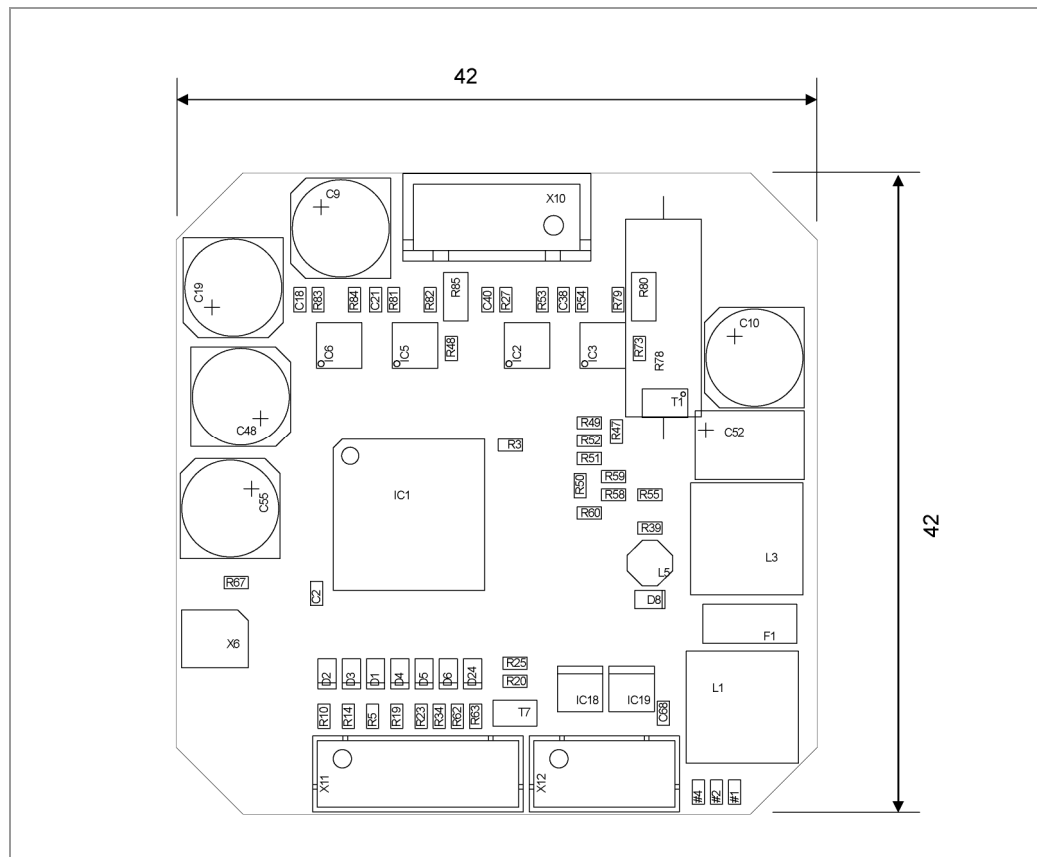

A complete set of datasheets is available for downloading at www.nanotec.de.

Index

A

Accessories for voltage supply 16

C

CANopen 11, 15, 16

Commissioning 9

Connector X10 14

Connector X11 12

Connector X12 15

D

dspDrive 5

F

Firmware 5

Functions 5

I

Input circuits 13

N

NanoJ 5

O

Operating modes

 CANopen 20

 serial 18

Operating voltage 15

Output circuits 13

P

Pin assignment

 connector X10 14

 connector X11 12

 connector X12 15

Plug connections 7

Protective circuits 23

R

RS485 network 16

T

Two-wire operation 16

V

Voltage supply 15