

Chapter 3 - Reference

REFERENCE

CiA DS-201..207	CAN Application Layer for Industrial Applications Version 1.1
CiA DS-301	Application Layer and Communication Profile Version 4.01
CiA DSP-402	Device Profile: Drive and Motion Control Version 1.1

DEFINITIONS & CONVENTIONS

CAN	Controller Area Network
CiA	CAN in Automation e. V. CAN-Bus international manufacturer and user organisation.
CAL	CAN Application Layer. The Application layer for CAN as specified by CiA.
COB	Communication Object is a CAN message. Data must be sent across a CAN network inside a COB.
COB-ID	COB-Identifier. Each CAN message has a single identifier. There are 2032 different identifiers in a CAN network.
NMT	Network Management. One of the services of the application layer. It performs initialisation, configuration and error handling in a CAN network.
PDO	Process Data Object. A CANopen message used to exchange process data.
SDO	Service Data Object. A CANopen message for parameters setting.
pp	Profile Position Mode.
pv	Profile Velocity Mode.
hm	Homing Mode.
ip	Interpolated Position Mode.
tq	Profile Torque Mode.
pc	Position Control Function.
ServoPac	Generic name of a TRANSTECHNIK servo drive family with resolver and encoder feedback input.
Numerical value	hexa is preceded with 0x, decimal otherwise
Dynamic Variable	An element of an object indicated by index and sub-index which can be mapped in a PDO. An element of an object is addressed by its index and its sub-index.

Dataflow An element of an object is qualified as dataflow (signal) if it is a variable (i.e. mappable). These variables can be of 8 bit, 16 bit or 32 bit. Depending on the using context, a dataflow must be of 16 bit or 32 bit or any size.

The dataflow can come from:

- An external source:
Examples : Encoder position 0x3129-0
Analog Input 0x31F1-1 (16 bit)
Analog Input 0x31F1-2 (32 bit)
- The CAN bus:
Example: Interpolated data 0x30C1-0 (32 bit)
- An internal signal:
Examples: Profile Speed Function Block output 0x3526-0 (32-bit)
User variable : 0x3710-3 (32-bit)

3.1 - CANOPEN COMMUNICATION

3.1.1 - COMMUNICATION OBJECTS

3.1.1.1 - Can Telegram

CAN TELEGRAM

SOM	COB-ID	RTR	CTRL	Data segment	CRC	ACK	EOM
-----	--------	-----	------	--------------	-----	-----	-----

SOM	Start Of Message
COB-ID	COB-Identifier of 11 bits
RTR	Remote Transmission Request
CTRL	Control field
Data	up to 8 bytes
CRC	Cyclic Redundancy Check
ACK	Acknowledge
EOM	End Of Message

3.1.1.2 - Default COB-ID

The COB-ID is of 11 bits. Node-ID (bits 0 - 6) is the drive address from 1 to 127.

10	9	8	7	6	5	4	3	2	1	0
Function Code				NODE-ID						

Default COB-ID:

Broadcast objects of the pre-defined connection set:

Object	Function Code	Resulting COB-ID	Communication Parameter at Index
NMT	0000	0	-
SYNC	0001	128 (80h)	1005h, 1006h, 1007h

Peer-to-peer objects of the pre-defined connection set:

Object	Function Code	Resulting COB-ID	Communication Parameter at Index
EMERGENCY	0001	129 (81h) - 255 (FFh)	1014h
PDO1 (TX)	0011	385 (181h) - 511 (1FFh)	1800h
PDO1 (RX)	0100	513 (201h) - 639 (27Fh)	1400h
PDO2 (TX)	0101	641 (281h) - 767 (2FFh)	1801h
PDO2 (RX)	0110	769 (301h) - 895 (37Fh)	1401h
PDO3 (TX)	0111	897 (381h) - 1023 (3FFh)	1802h
PDO3 (RX)	1000	1025 (401h) - 1151 (47Fh)	1402h
PDO4 (TX)	1001	1153 (481h) - 1279 (4FFh)	1803h
PDO4 (RX)	1010	1281 (501h) - 1407 (57Fh)	1403h
SDO (TX)	1011	1409 (581h) - 1535 (5FFh)	1200h
SDO (RX)	1100	1537 (601h) - 1663 (67Fh)	1200h

TX = Transmit from drive to master
 RX = Receive by drive from master

3.1.1.3 - Network Management Objects

NMT Protocols

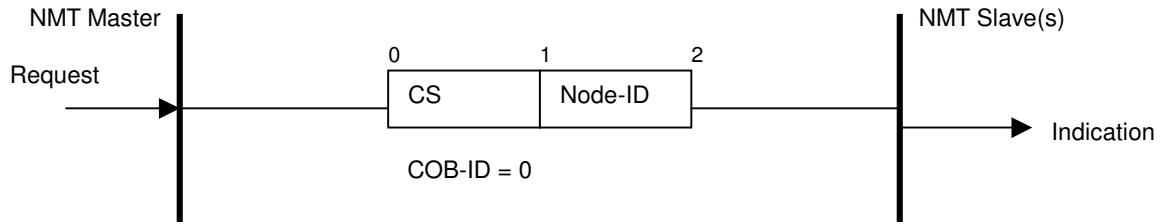

NMT Protocol	Command Specifier CS	Remarks
Start Remote Node	1	Change to NMT Operational state
Stop Remote Node	2	Change to NMT Stop state
Enter Pre-Operational	128	
Reset Node	129	
Reset Communication	130	

Node-ID: The Node-ID indicates the address of the drive. If Node_ID = 0, the protocol addresses all NMT slaves.

3.1.1.4 - Synchronisation Object

The SYNC object is a broadcast message sent by the master. This message provides a network clock. The period is specified by the communication cycle period (object 0x1006). The ServoPac servo-drives use this SYNC message to synchronize their local clock.

At least 180 ms are necessary for the servo-drive to start the synchronisation.

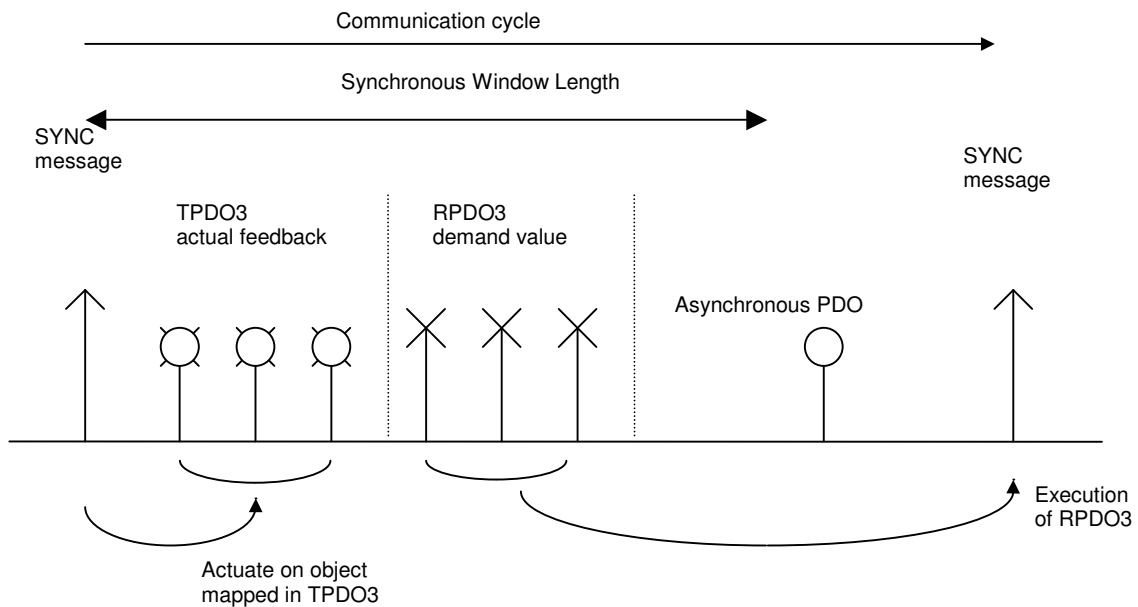

COB-ID Sync Message

Index	0x1005
Name	COB-ID Sync Message
Object Code	VAR
Data Type	Unsigned32
Object Class	all
Access	rw
PDO Mapping	No
Default Value	0x00000080

This object defines the COB-ID of the synchronisation object (SYNC).
The ServoPac drive does not support 29-bit ID.

Bit number	Value	Meaning
31 (MSB)		No Bootup message
30	0	Device does not generate SYNC message
	1	Device generates SYNC message
29	0	11-bit ID (CAN 2.0 A)
28-11	0	
10-0 (LSB)	x	bits 10-0 of SYNC COB-ID

Communication Cycle Period

Index	0x1006
Name	Communication Cycle Period
Object Code	VAR
Data Type	Unsigned32
Access	rw
PDO Mapping	No
Unit	µs
Value Range	0..20000 (only the values multiples of 500 are supported)
Default Value	10000

This object defines the communication cycle. This period is also used for the synchronisation in interpolated position mode. When the value of this object is reset at 0, the synchronisation is no more operative.

3.1.1.5 - Process Data Objects (PDO)

PDOs are unconfirmed messages used for real-time data exchange.
PDOs sent by the master are RPDOs and PDOs sent by the drive are TPDOs.

Data in each PDO are defined by a list of objects (PDO mapping).

There are 4 pdos: TPDO1, RPDO1, TPDO2, RPDO2, TPDO3, RPDO3, TPDO4 and RPDO4.

Each PDO is defined by:

PDO communication parameters with
 object 0x1400, 0x1401, 0x1402, 0x1403 for RPDOs
 object 0x1800, 0x1801, 0x1802, 0x1803 for TPDOs

PDO mapping with
 object 0x1600, 0x1601, 0x1602, 0x1603 for RPDOs
 object 0x1A00, 0x1A01, 0x1A02, 0x1A03 for TPDOs

Communication parameters

Communication parameters are:

- PDO COB-ID
- Transmission type

The distribution of COB-ID is defined by default. The modification of COB-ID of PDO can be made in *NMT Pre-Operational State*; the new COB-ID will take effect when the NMT state machine changes to *Operation State*. The modification must not be taken in *NMT Operational State*, otherwise a *Reset_Communication* will be necessary before the new COB-ID takes effect.

Transmission type supported by ServoPac Servo Drives:

Transmission type	PDO transmission				
	cyclic	acyclic	synchronous	asynchronous	RTR only
1	TPDO1 TPDO2 TPDO3 TPDO4		TPDO1 TPDO2 TPDO3 TPDO4		
2-240					
253					TPDO1 TPDO2 TPDO3 TPDO4
254					
255				TPDO1 TPDO2 TPDO3 TPDO4	

- Transmission types 1 - 240 are synchronous transmissions with regard to the SYNC messages. A value between 1 and 240 means that the PDO is synchronously and cyclically transferred. The transmission type indicates the number of SYNC which are necessary to trigger PDO transmissions.
- Transmission type 253 means that the PDO is only transmitted on remote transmission request.
- Transmission type 255 is event trigger: The PDO will be transmitted when the first object (must be 16-bit) mapped in PDO has changed.

PDO transmission modes of:

- *Synchronous*: the message is transmitted in synchronisation with the SYNC message. A synchronous message must be transmitted within a pre-defined time-window immediately after the SYNC message.
- *Asynchronous*: the message is sent independently of the SYNC message.

Triggering modes:

- *Event_Driven*:
Message transmission by reception of SYNC.
Message transmission by specific event.

- *Remotely requested*: the transmission of an asynchronous PDO is initiated on reception of a remote request by any other device.

PDO Mapping

The sub-index 0 of mapping parameter contains the number of valid entries within the mapping record. This number of entries is also the number of application variables which shall be transmitted/received with the corresponding PDO. The sub-index 1 to number of entries contains the information about the mapped application variables. These entries describe the PDO contents by their index, sub-index and length (in bits).

Structure of PDO Mapping Entry:

Byte :	MSB	LSB
	index (16 bit)	sub-index (8 bit) object length (8 bit)

Principle of PDO mapping:

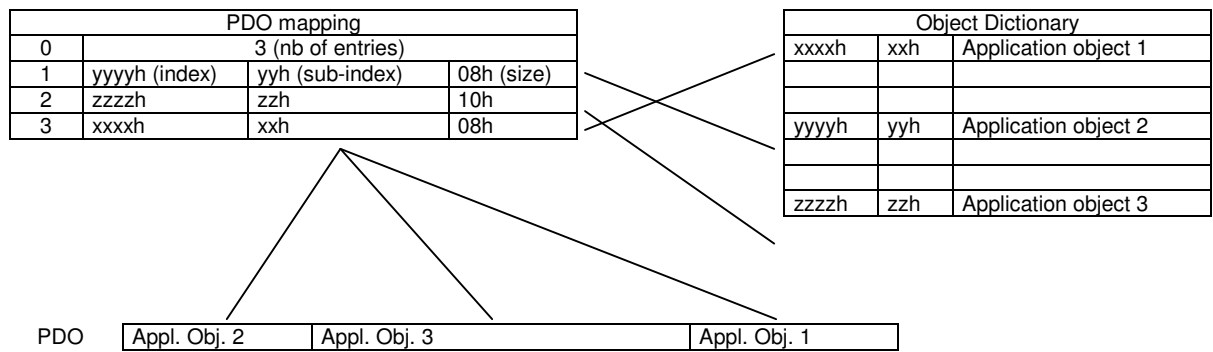

Multiplexed data

The multiplexed data is used to multiplex more than one axis demand value into one message RPDO. It is possible to send 4 axis demand values (16 bit absolute) with one RPDO. Therefore, the controller must modify the COB-ID of RPDO of each axis to the same cob-ID. For example (see also the following diagram), for axis 1, object 60C1-1 is mapped into the first mapped object (object 1602-1), for axis 2, object 60C1-1 is mapped into the 2nd mapped object (object 1602-2) and so on... For each axis, the balance of the mapped objects must be mapped with a dummy object.

A dummy object mapped is realized with objects:

- 0x0002 (integer8)
- 0x0003 (integer16)
- 0x0004 (integer32)
- 0x0005 (unsigned8)
- 0x0006 (unsigned16)
- 0x0007 (unsigned32)

These objects can be used to map a PDO as a dummy object but cannot be accessed via SDO (see DS-301, 9.5.3 Data type entry specification).

Example of multiplexed data :

	MSB			LSB
TPDO Cob-ID 0x501	<i>Data_Ax4</i> (16bit)	<i>Data_Ax3</i> (16bit)	<i>Data_Ax2</i> (16bit)	<i>Data_Ax1</i> (16bit)

This PDO is transmitted with COB-ID 0x501 and contains 16bits x 4 of data

Object	Value
RPDO1 COB-ID (object 1400-1)	0x501
Number of mapped objects (object 1600-0)	0x1
1 st Mapped Object (object 1600-1)	0x60C10110

In the drive 1, “Data_Ax1” will be written in the object 60C1-1

Object	Value
RPDO1 COB-ID (object 1400-1)	0x501
Number of mapped objects (object 1600-0)	0x2
1 st Mapped Object (object 1600-1)	0x00060010 (dummy)
2 nd Mapped Object (object 1600-2)	0x60C10110

In the drive 2, “Data_Ax2” will be written in the object 60C1-1

Object	Value
RPDO1 COB-ID (object 1400-1)	0x501
Number of mapped objects (object 1600-0)	0x3
1 st Mapped Object (object 1600-1)	0x00060010 (dummy)
2 nd Mapped Object (object 1600-2)	0x00060010 (dummy)
3 rd Mapped Object (object 1600-3)	0x60C10110

In the drive 3, “Data_Ax3” will be written in the object 60C1-1

Object	Value
RPDO1 COB-ID (object 1400-1)	0x501
Number of mapped objects (object 1600-0)	0x4
1 st Mapped Object (object 1600-1)	0x00060010 (dummy)
2 nd Mapped Object (object 1600-2)	0x00060010 (dummy)
3 rd Mapped Object (object 1600-2)	0x37100110
4 th Mapped Object (object 1600-4)	0x60C10110

In the drive 4, "Data_Ax4" will be written in the object 60C1-1 and "Data_Ax3" in the object 3710-1

Receive PDO Communication Parameter

Object 0x1400: 1st Receive PDO Communication Parameter

Index	0x1400
Name	1st Receive PDO Communication Parameter (RPDO1)
Object Code	RECORD
Number of Elements	2

Value Description

Sub Index	1
Description	COB-ID
Data Type	Unsigned32
Access	rw
PDO Mapping	No
Default Value	0x200 + Node-ID

Sub Index	2
Description	Transmission Type
Data Type	Unsigned8
Access	rw
PDO Mapping	No
Default Value	253

Object 0x1401: 2nd Receive PDO Communication Parameter

Index	0x1401
Name	2nd Receive PDO Communication Parameter (RPDO2)
Object Code	RECORD
Number of Elements	2

Value Description

Sub Index	1
Description	COB-ID
Data Type	Unsigned32
Access	rw
PDO Mapping	No
Default Value	0x300 + Node-ID

Sub Index	2
Description	Transmission Type
Data Type	Unsigned8
Access	rw
PDO Mapping	No
Default Value	253

Object 0x1402: 3rd Receive PDO Communication Parameter

Index	0x1402
Name	3rd Receive PDO Communication Parameter (RPDO3)
Object Code	RECORD
Number of Elements	2

Value Description

Sub Index	1
Description	COB-ID
Data Type	Unsigned32
Access	rw
PDO Mapping	No
Default Value	0x400 + Node-ID

Sub Index	2
Description	Transmission Type
Data Type	Unsigned8
Access	rw
PDO Mapping	No
Default Value	1

Object 0x1403: 4th Receive PDO Communication Parameter

Index	0x1403
Name	4th Receive PDO Communication Parameter (RPDO4)
Object Code	RECORD
Number of Elements	2

Value Description

Sub Index	1
Description	COB-ID
Data Type	Unsigned32
Access	rw
PDO Mapping	No
Default Value	0x500 + Node-ID

Sub Index	2
Description	Transmission Type
Data Type	Unsigned8
Access	rw
PDO Mapping	No
Default Value	0

Receive PDO Mapping**Object 0x1600: 1st Receive PDO Mapping**

Index	0x1600
Name	1st Receive PDO Mapping
Object Code	RECORD
Number of Elements	0..4

Value Description

Sub Index	0
Description	number of mapped objects
Data Type	Unsigned8
Access	rw
PDO Mapping	No
Default Value	1

Sub Index	1
Description	1st mapped object
Data Type	Unsigned32
Access	rw
PDO Mapping	No
Default Value	0x60400010 (control word)

Object 0x1601: 2nd Receive PDO Mapping

Index	0x1601
Name	2nd Receive PDO Mapping
Object Code	RECORD
Number of Elements	0..4

Value Description

Sub Index	0
Description	number of mapped objects
Data Type	Unsigned8
Access	rw
PDO Mapping	No
Default Value	1

Sub Index	1
Description	1st mapped object
Data Type	Unsigned32
Access	rw
PDO Mapping	No
Default Value	0x60FF0020 (target velocity)

Object 0x1602: 3rd Receive PDO Mapping

Index	0x1602
Name	3rd Receive PDO Mapping
Object Code	RECORD
Number of Elements	0..4

Value Description

Sub Index	0
Description	number of mapped objects
Data Type	Unsigned8
Access	rw
PDO Mapping	No
Default Value	1

Sub Index	1
Description	1st mapped object
Data Type	Unsigned32
Access	rw
PDO Mapping	No
Default Value	0x60C10120 (Interpolated data record)

Object 0x1603: 4th Receive PDO Mapping

Index	0x1602
Name	4th Receive PDO Mapping
Object Code	RECORD
Number of Elements	0..4

Value Description

Sub Index	0
Description	number of mapped objects
Data Type	Unsigned8
Access	rw
PDO Mapping	No
Default Value	1

Sub Index	1
Description	1st mapped object
Data Type	Unsigned32
Access	rw
PDO Mapping	No
Default Value	

Transmit PDO Parameter

Object 0x1800: 1st Transmit PDO Parameter

Index	0x1800
Name	1st Transmit PDO Communication Parameter (TPDO1)
Object Code	RECORD
Number of Elements	2

Value Description

Sub Index	1
Description	COB-ID
Data Type	Unsigned32
Access	rw
PDO Mapping	No
Default Value	0x180 + Node-ID

Sub Index	2
Description	Transmission Type
Data Type	Unsigned8
Access	rw
PDO Mapping	No
Default Value	253

Object 0x1801: 2nd Transmit PDO Parameter

Index	0x1801
Name	2nd Transmit PDO Communication Parameter (TPDO2)
Object Code	RECORD
Number of Elements	2

Value Description

Sub Index	1
Description	COB-ID
Data Type	Unsigned32
Access	rw
PDO Mapping	No
Default Value	0x280 + Node-ID

Sub Index	2
Description	Transmission Type
Data Type	Unsigned8
Access	rw
PDO Mapping	No
Default Value	253

Object 0x1802: 3rd Transmit PDO Parameter

Index	0x1802
Name	3rd Transmit PDO Communication Parameter (TPDO3)
Object Code	RECORD
Number of Elements	2

Value Description

Sub Index	1
Description	COB-ID
Data Type	Unsigned32
Access	rw
PDO Mapping	No
Default Value	0x380 + Node-ID

Sub Index	2
Description	Transmission Type
Data Type	Unsigned8
Access	rw
PDO Mapping	No
Default Value	1

Object 0x1803: 4th Transmit PDO Parameter

Index	0x1803
Name	4th Transmit PDO Communication Parameter (TPDO4)
Object Code	RECORD
Number of Elements	2

Value Description

Sub Index	1
Description	COB-ID
Data Type	Unsigned32
Access	rw
PDO Mapping	No
Default Value	0x480 + Node-ID

Sub Index	2
Description	Transmission Type
Data Type	Unsigned8
Access	rw
PDO Mapping	No
Default Value	1

Transmit PDO Mapping**Object 0x1A00: 1st Transmit PDO Mapping**

Index	0x1A00
Name	1st Transmit PDO Mapping
Object Code	RECORD
Number of Elements	0..4

Value Description

Sub Index	0
Description	number of mapped objects
Data Type	Unsigned8
Access	rw
PDO Mapping	No
Default Value	1

Sub Index	1
Description	1st mapped object
Data Type	Unsigned32
Access	rw
PDO Mapping	No
Default Value	0x60410010 (status word)

Object 0x1A01: 2nd Transmit PDO Mapping

Index	0x1A01
Name	2nd Transmit PDO Mapping
Object Code	RECORD
Number of Elements	0..4

Value Description

Sub Index	0
Description	number of mapped objects
Data Type	Unsigned8
Access	rw
PDO Mapping	No
Default Value	1

Sub Index	1
Description	1st mapped object
Data Type	Unsigned32
Access	rw
PDO Mapping	No
Default Value	0x606C0020 (velocity value)

Object 0x1A02: 3rd Transmit PDO Mapping

Index	0x1A02
Name	3rd Transmit PDO Mapping
Object Code	RECORD
Number of Elements	0..4

Value Description

Sub Index	0
Description	number of mapped objects
Data Type	Unsigned8
Access	rw
PDO Mapping	No
Default Value	1

Sub Index	1
Description	1st mapped object
Data Type	Unsigned32
Access	rw
PDO Mapping	No
Default Value	0x60640020 (Actual position value)

Object 0x1A03: 4th Transmit PDO Mapping

Index	0x1A03
Name	4th Transmit PDO Mapping
Object Code	RECORD
Number of Elements	0..4

Value Description

Sub Index	0
Description	number of mapped objects
Data Type	Unsigned8
Access	rw
PDO Mapping	No
Default Value	0

Sub Index	1
Description	1st mapped object
Data Type	Unsigned32
Access	rw
PDO Mapping	No
Default Value	0

Manufacturer PDO Transmission Mode

The ServoPac drive has a special transmission mode for the TPDO_n defined by a TPDO_n_Control (object 0x23A1-n) and a TPDO_Count (object 0x23A0). The purpose of this mode is to control the number of cyclic TPDO_n for each axis.

TPDO_n_Control is preset for each axis. TPDO_Count is counter value of the host. For each axis, when TPDO_Count is equal to TPDO_n_Control, it will transmit the TPDO_n in synchronisation with the SYNC message. The transmission type for the TPDO_n must be 254.

Example: RPDO1 is used to transmit TPDO_Count value.

To be sure that all axes have got the same value of TPDO_Count at the same synchronisation, the RPDO1 COB-ID must be redefined to be the same for all axes and mapped with TPDO_Count object.

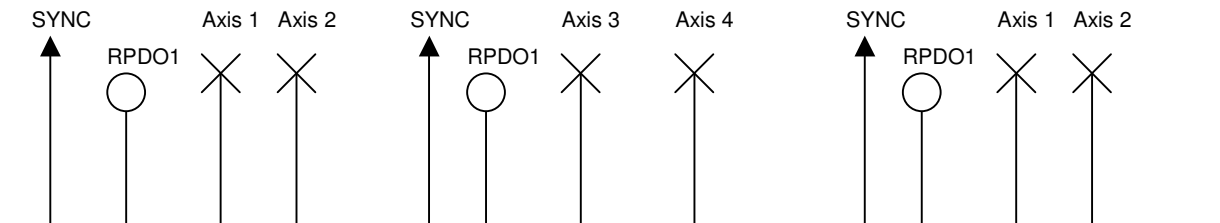

Index	0x23A0
Name	TPDO_Count
Object Code	VAR
Data Type	Unsigned8
Object Class	all
Access	rw
PDO Mapping	No
Value Range	0..255
Default Value	0

Index	0x23A1
Name	TPDO Control
Object Code	ARRAY
Number of Elements	4

Value Description

Sub Index	1-4
Description	TPDO control for TPDO n.
Data Type	Unsigned8
Access	rw
PDO Mapping	No
Value Range	0..255
Default Value	0

3.1.1.6 - Service Data Objects (SDO)

The SDO is a communication channel with 2 basic characteristics:

- Client/Server relationship,
- Object Dictionary.

Client/Server:

This is a relationship between a single client and a single server (Servo Drive). A client issues a request (upload/download) thus triggering the server to perform a certain task. After finishing the task, the server answers the request.

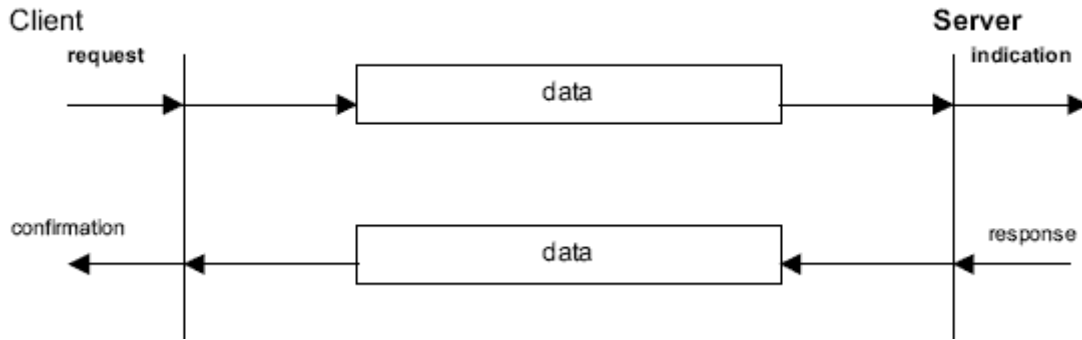

Object Dictionary:

All objects (variables, constants, records...) of the server are defined as a list of objects where each element is appointed by an index and a sub-index. This list of objects is called object dictionary. This object dictionary allows the client the access to all objects of the server. The Servo Drive object dictionary consists of 2 parts: the communication profile (DS-301) for the objects related to the CAN communication and the device profile (DSP-402) for objects related to the drive functionality.

For more information about the SDO protocol, please report to the CiA DS-301 version 4.01 specification.

SDO Communication between drives

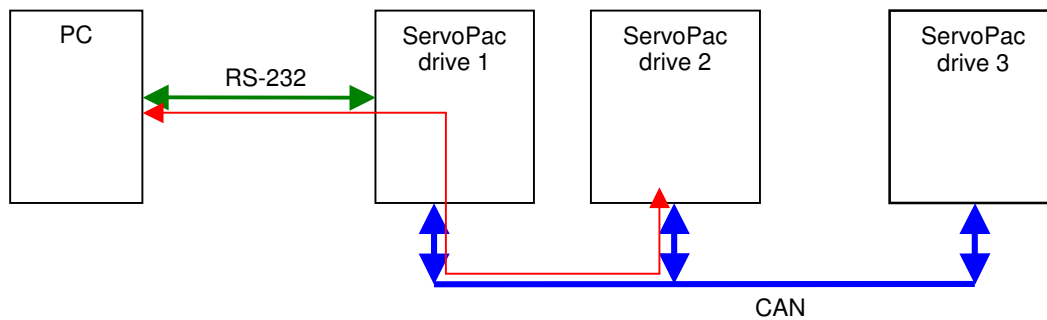

The ServoPac drive supports Node ID setting by switches from 1 to 63.

SDO message for node ID from 64 to 127 are used for communication between drives. The ServoPac drive re-directs SDO message from RS-232 by PC to CANbus.

Example: 3 drives with Node ID 1, 2 and 3.

direct SDO messages: cobID = 0x601/0x581, 0x602/0x582 and 0x603/0x583

re-redirect SDO messages: cobID = 0x641/0x5C1, 0x642/0x5C2 and 0x643/0x5C3

This allows the PC to communicate with any drive only via one RS-232 connection (example of the red line in the above diagram).

With an ServoPac drive with node ID = n, there must not be another device in the CANopen network with node ID = n+64, to avoid conflict with the re-direction SDO message of the ServoPac drive.

3.1.1.7 - Emergency Objects

Byte	0	1	2	3	4	5	6	7
Content	Emergency Error Code		Error register (object 1001h)	Manufacturer Specific Error Field				
				Error Code				

See object 0x3022 for the Error Code.

3.1.1.8 - Node Guarding

Network error behaviour

Index	0x205E
Name	Network Error Behaviour
Object Code	VAR
Data Type	Unsigned16
Object Class	all
Access	rw
PDO Mapping	No
Default Value	0

This object defines the drive behaviour when a Node guarding error occurs.

Value	Description
0	No Operation
1	Drive Error
2	Goes into Bus Stop state

See also NMT State machine

3.1.2 - NETWORK INITIALISATION

3.1.2.1 - NMT State Machine

The NMT state machine defines the communication status.

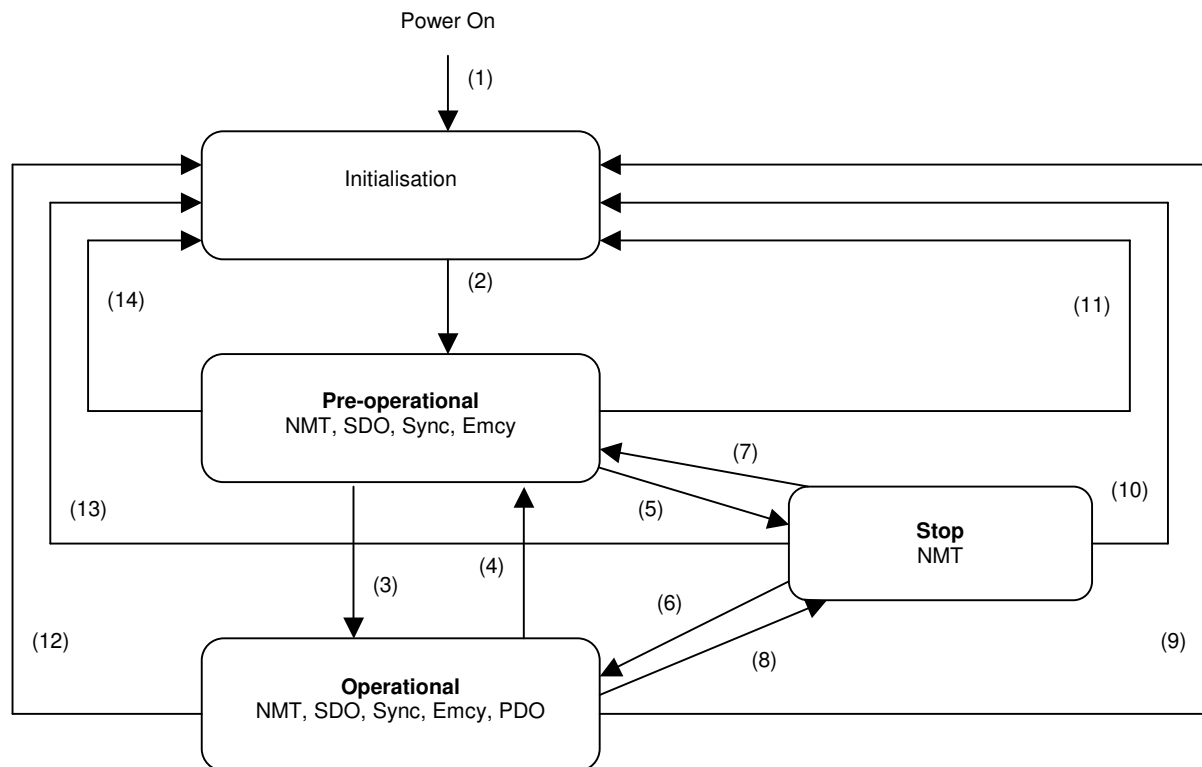

(1)	At Power on, the initialisation state is automatically entered
(2)	Once the Initialisation over, Pre-Operational is automatically entered
(3), (6)	Start_Remote_Node indication
(4), (7)	Enter_Pre-Operational_State indication
(5), (8)	Stop_Remote_Node indication
(9), (10), (11)	Reset_Node indication
(12), (13), (14)	Reset_Communication indication

Minimum Boot-Up consists of one CAN telegram : a broadcast Start_Remote_Node message.

NMT reset

NMT_Reset_Comm:

The NMT_Reset_Comm restores communication parameters (default CobIDs, PDO mapping...) to the power-on values.

The NMT_Reset_Node:

Depends on object 0x205D, the NMT_Reset_Node can re-load the drive parameter file, then a NMT_Reset_Comm is executed.

NMT reset configuration

Index	0x205D
Name	NMT_Reset_configuration
Object Code	VAR
Data Type	Unsigned16
Object Class	all
Access	rw
PDO Mapping	No
Default Value	0

This object defines the bootup behaviour of the drive.

Bit	Description
0	0 -
	1 Load drive parameters file

See also NMT State machine.

3.1.2.2 - Bootup Protocol

This protocol is used to signal that a NMT slave has entered the node state PRE-OPERATIONAL after the state INITIALISING. The protocol uses the same identifier as the error control protocols.

Bootup Event

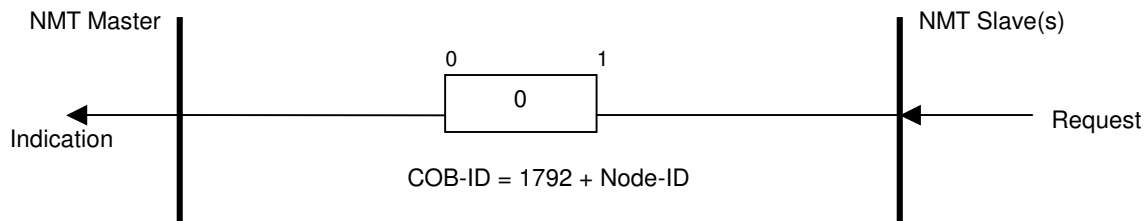

One data byte is transmitted with value 0.

Bootup configuration

Index	0x2010
Name	Bootup configuration
Object Code	VAR
Data Type	Unsigned16
Object Class	all
Access	rw
PDO Mapping	No
Default Value	0

This object defines the bootup behaviour of the drive.

Value	Description
0	No Bootup message
1	Bootup message is sent when the drive goes into Pre-Op state

See also NMT State machine, Bootup protocol.

3.1.2.3 - Initialisation procedure

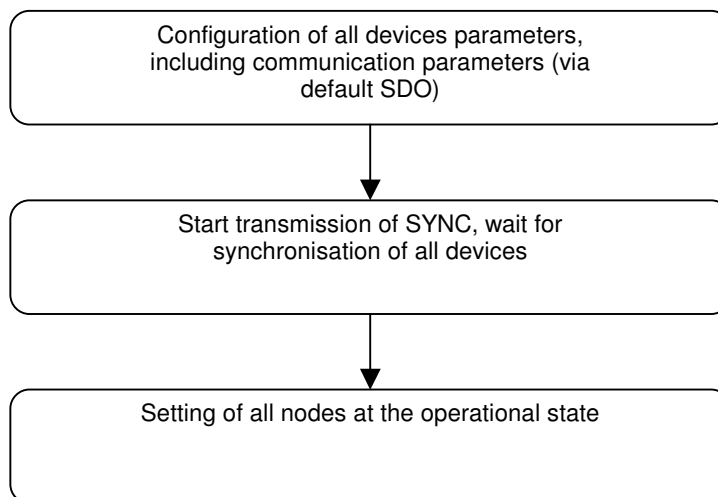

3.2 - DEVICE PROFILE

3.2.1 - DEVICE CONTROL

3.2.1.1 - Drive State Machine

The state machine describes the status and the control sequence of the drive.

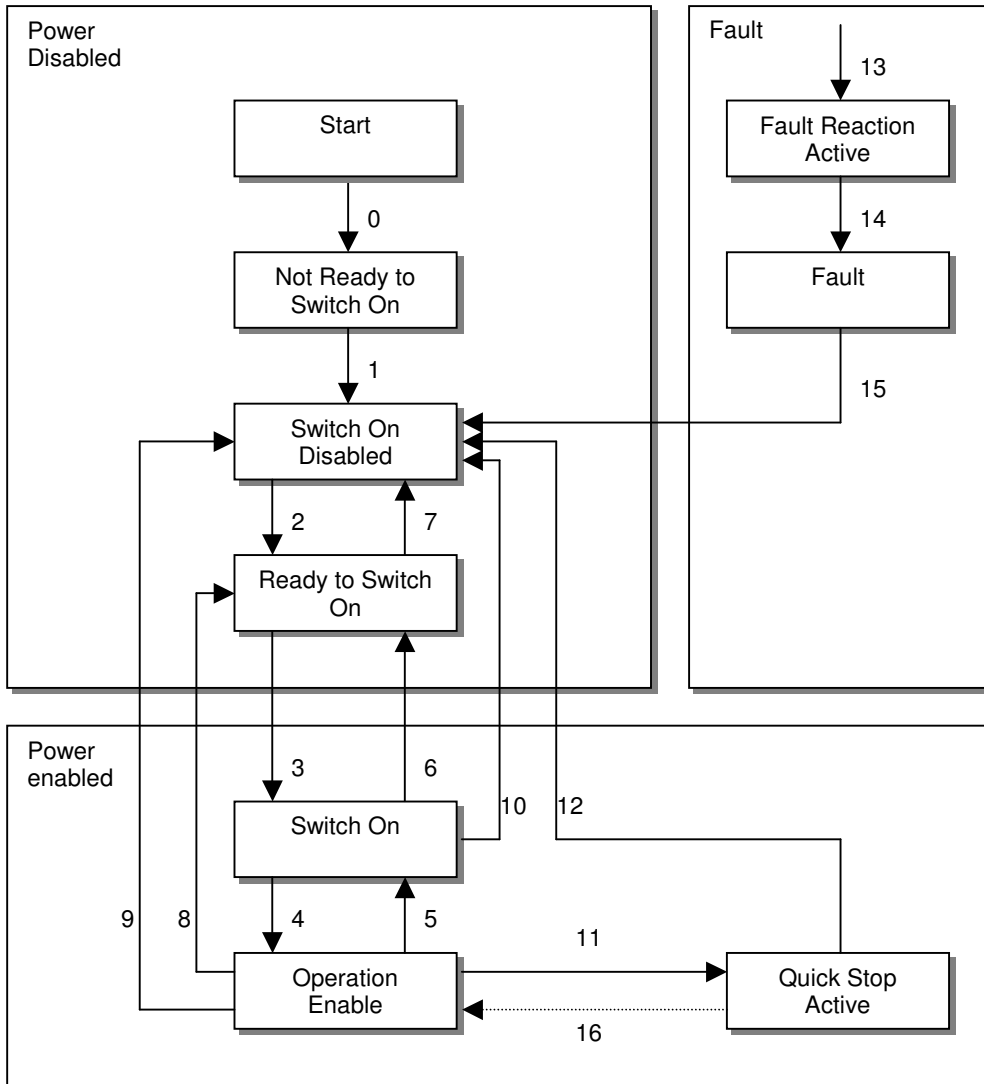

Drive State

The following states of the device are possible:

- NOT READY TO SWITCH ON

*Low level power has been applied to the drive.
The drive is being initialized or is running self test.
A brake, if present, has to be applied in this state.
The drive function is disabled.*

- SWITCH ON DISABLED

*Drive initialization is complete.
The drive parameters have been set up.
Drive parameters may be changed.
High voltage may not be applied to the drive, (e.g. for safety reasons).
The drive function is disabled.*

- **READY TO SWITCH ON**
*High voltage may be applied to the drive.
 The drive parameters may be changed.
 The drive function is disabled.*
- **SWITCHED ON**
*High voltage has been applied to the drive.
 The power amplifier is ready.
 The drive parameters may be changed.
 The drive function is disabled.*
- **OPERATION ENABLE**
*No faults have been detected.
 The drive function is enabled and power is applied to the motor.
 The drive parameters may be changed.
 (This corresponds to normal operation of the drive.)*
- **QUICK STOP ACTIVE**
*The drive parameters may be changed.
 The quick stop function is being executed.
 The drive function is enabled and power is applied to the motor.*
- **FAULT REACTION ACTIVE**
*The drive parameters may be changed.
 A fault has occurred in the drive.
 The quick stop function is being executed.
 The drive function is enabled and power is applied to the motor.*
- **FAULT**
*The drive parameters may be changed.
 A fault has occurred in the drive.
 High voltage switch-on/-off depends on the application.
 The drive function is disabled.*

State Transitions

State transitions are caused by internal events in the drive or by commands from the host via the *control word*.

- **State Transition 0: START -> NOT READY TO SWITCH ON**
*Event: Reset.
 Action: The drive self-tests and/or self-initializes.*
- **State Transition 1: NOT READY TO SWITCH ON -> SWITCH ON DISABLED**
*Event: The drive has self-tested and/or initialized successfully.
 Action: Activate communication.*
- **State Transition 2: SWITCH ON DISABLED -> READY TO SWITCH ON**
*Event: 'Shutdown' command received from host.
 Action: None*
- **State Transition 3: READY TO SWITCH ON -> SWITCHED ON**
*Event: 'Switch On' command received from host.
 Action: The power section is switched on if it is not already switched on.*
- **State Transition 4: SWITCHED ON -> OPERATION ENABLE**
*Event: 'Enable Operation' command received from host.
 Action: The drive function is enabled.*
- **State Transition 5: OPERATION ENABLE -> SWITCHED ON**
*Event: 'Disable Operation' command received from host.
 Action: The drive operation will be disabled.*
- **State Transition 6: SWITCHED ON -> READY TO SWITCH ON**
*Event: 'Shutdown' command received from host.
 Action: The power section is switched off.*

- State Transition 7: READY TO SWITCH ON -> SWITCH ON DISABLED
Event: 'Quick Stop' and 'Disable Voltage' command received from host.
Action: None

- State Transition 8: OPERATION ENABLE -> READY TO SWITCH ON
Event: 'Shutdown' command received from host.
Action: The power section is switched off immediately, and the motor is free to rotate if unbraked.

- State Transition 9: OPERATION ENABLE -> SWITCH ON DISABLED
Event: 'Disable Voltage' command received from host.
Action: The power section is switched off immediately, and the motor is free to rotate if unbraked.

- State Transition 10: SWITCHED ON -> SWITCH ON DISABLED
Event: 'Disable Voltage' or 'Quick Stop' command received from host.
Action: The power section is switched off immediately, and the motor is free to rotate if unbraked.

- State Transition 11: OPERATION ENABLE -> QUICK STOP ACTIVE
Event: 'Quick Stop' command received from host.
Action: The quick stop function is executed.

- State Transition 12: QUICK STOP ACTIVE -> SWITCH ON DISABLED
Event: 'Quick Stop' is completed or 'Disable Voltage' command received from host.
This transition is possible, if the Quick-Stop-Option-Code is different from 5 (stay in the state 'Quick Stop Active').
Action: The power section is switched off.

- State Transition 13: All states -> FAULT REACTION ACTIVE
A fault has occurred in the drive.
Action: Execute appropriate fault reaction.

- State Transition 14: FAULT REACTION ACTIVE -> FAULT
Event: The fault reaction is completed.
Action: The drive function is disabled. The power section may be switched off.

- State Transition 15: FAULT -> SWITCH ON DISABLED
Event: 'Fault Reset' command received from host.
Action: A reset of the fault condition is carried out if no fault currently exists in the drive.
After leaving the state Fault the Bit 'Fault Reset' of the controlword has to be cleared by the host.

- State Transition 16: QUICK STOP ACTIVE -> OPERATION ENABLE
Event: 'Enable Operation' command received from host. This transition is possible if the Quick-Stop-Option-Code is 5, 6, 7 or 8.
Action: The drive function is enabled.

Objects definition

Index	Object	Name	Type	Attr.
0x6040	VAR	Control Word	Unsigned16	rw
0x6041	VAR	Status Word	Unsigned16	ro

Control Word

Index	0x6040
Name	Control Word
Object Code	VAR
Data Type	Unsigned16
Object Class	all
Access	rw
PDO Mapping	Possible
Default Value	0000

Bit Number	Function
0	Switch On
1	Disable Voltage
2	Quick Stop
3	Enable Operation
4	Operation Mode Specific
5	Operation Mode Specific
6	Operation Mode Specific
7	Reset Fault (rising edge)
8	Halt (mode PV, PT, AS, AT)

Device control commands are triggered by the following bit patterns in the control word:

Command / Bit of the control_word	bit 7 Fault Reset	bit 3 Enable Operation	bit 2 Quick Stop	bit 1 Disable Voltage	bit 0 Switch On	Transition
Shutdown	X	X	1	1	0	2, 6, 8
Switch On	X	X	1	1	1	3
Disable Voltage	X	X	X	0	X	7, 9, 10, 12
Quick Stop	X	X	0	1	X	7, 10, 11
Disable Operation	X	0	1	1	1	5
Enable Operation	X	1	1	1	1	4, 16
Fault Reset	↑	X	X	X	X	15

Bit 4, 5, 6 are operation mode specific:

Mode	Bit 4	Bit 5	Bit6
Profile Position Mode	new set point	change_set_immediately	0: absolute 1: relative
Homing Mode	Homing Operation Start	reserved	reserved
Interpolated Position Mode	enable ip_mode	reserved	reserved
Profile Velocity Mode	reserved	reserved	reserved
Sequence Mode	start sequence	stop sequence	reserved
Servo Mode	enable servo_mode	reserved	reserved

Correct sequence to enable the drive:

Seq	Control Word (0x6040)	Corresponding Status Word (0x6041)	Remarks
1	0x0000	0x0240	state "Switch On Disabled" drive is disabled
2	0x0006	0x0221	state "Ready To Switch On" drive is disabled
3	0x0007	0x0223	state "Switch On" drive is enabled
4	0x000F	0x0227	state "Operation Enable" drive is enabled

Notes:

- Some independent status bits may be set and are not represented in the table above. The mask for testing the status word is 0x026F
- Seq 1 (control word = 0x0000) and seq 3 (control word = 0x0007) may be omitted
- In some operation mode (interpolated position mode, servo mode...), the bit 4 of the control word must also be set after seq 4 to be fully operational. When switching between the modes, it is necessary to reset bit 4 of control word before changing the mode and then set it afterwards.

Status Word

Index	0x6041
Name	Status Word
Object Code	VAR
Data Type	Unsigned16
Object Class	all
Access	ro
PDO Mapping	Possible
Default Value	-

The status word indicates the current status of the drive. It is possible to define the TPDO to be transmitted at every change of the status word (Device Event transmission type).

Bit Number	Function
0	Ready to Switch On
1	Switch On
2	Operation Enabled
3	Fault
4	Voltage Enabled
5	Quick Stop
6	Switch On Disabled
7	Warning
8	
9	Remote
10	Target Reached
11	
12	Operation Mode Specific
13	Operation Mode Specific
14	
15	Manufacturer Specific: Drive Busy

Device Status Bit Meaning:

State	Bit 6 Switch On Disable	Bit 5 Quick Stop	Bit 3 Fault	Bit 2 Operation Enable	Bit 1 Switched On	Bit 0 Ready to Switch On
Not Ready to Switch On	0	X	0	0	0	0
Switch On Disabled	1	X	0	0	0	0
Ready to Switch On	0	1	0	0	0	1
Switched On	0	1	0	0	1	1
Operation Enable	0	1	0	1	1	1
Fault	0	X	1	0	0	0
Fault Reaction Active	0	X	1	1	1	1
Quick Stop Active	0	0	0	1	1	1

Bits 12, 13 are operation mode specific:

Mode	Bit 12	Bit 13
Profile Position Mode	setpoint acknowledge	Following Error
Homing Mode	Homing attained	Homing error
Interpolated Position Mode	Ip-Mode active	reserved
Profile Velocity Mode	Speed = 0	reserved
Servo Mode	servo_mode active	reserved
Sequence Mode	POS	SEQ
Stepper Emulation Mode	Pulse OK	Pulse Cnt

3.2.1.2 - Error & Warning

Error are displayed in object 0x3022 (2 x 32-bit), each bit in this object correspond error.
 The same bit in object 0x3025 allows to inhibit the corresponding error.
 An error can be cleared by "Reset Fault" bit in control word (0x6040).

Index	Object	Name	Type	Attr.
0x3022	ARRAY	Error words		ro
0x3024	VAR	Warning		ro
0x3025	ARRAY	Error Inhibition		rw

Index	0x3022
Name	Error word
Object Code	ARRAY
Number of Elements	3

Value Description

This object contains two 32-bit words in which one bit is assigned to a difference error.
 The Error code is the value which will be sent as an emergency message (EMCY).

Sub Index	1
Description	Error monitoring
Data Type	Unsigned32
Object Class	all
Access	ro
PDO Mapping	No
Value	See below
Default value	No

Bit	Value	Error Code	Function
0	0x00000001	1	Hardware System 2 Error
1	0x00000002	2	24 Volt Error
2	0x00000004	3	Undervolt (temporized)
3	0x00000008	4	Braking system error
4	0x00000010	5	Safety channel 2 Error
5	0x00000020	6	Overvoltage
6	0x00000040	7	Internal Communication 2 Error
7	0x00000080	8	Short-circuit
8	0x00000100	9	Main Phase Error
9	0x00000200	10	Mains phase loss
10	0x00000400	11	Power Module over-temperature
11			
12	0x00001000	13	Fan
13			
14			
15			
16	0x00010000	17	Current measurement offset
17	0x00020000	18	Overcurrent
18	0x00040000	19	Encoder counting error
19	0x00080000	20	Resolver tracking error
20	0x00100000	21	Resolver (cable interrupted)
21	0x00200000	22	Encoder (cable interrupted)
22	0x00400000	23	Encoder (Z marker)
23			
24			
25			
26			
27	0x08000000	28	Power Stage Controller Error
28	0x10000000	29	Manufacturer parameters error
29	0x20000000	30	Internal Communication 1 error
30	0x40000000	31	Configuration error
31	0x80000000	32	System error

Sub Index	2
Description	Error monitoring
Data Type	Unsigned32
Object Class	all
Access	ro
PDO Mapping	No
Value	See below
Default value	No

Bit	Value	Error Code	Function
0			
1			
2	0x00000004	35	Position following error
3			
4	0x00000010	37	Motor Temperature error
5	0x00000020	38	I²t error
6			
7	0x00000080	40	Busy
8	0x00000100	41	Calibration parameters file error
9	0x00000200	42	Drive parameters file error
10	0x00000400	43	User parameters file error
11	0x00000800	44	Sequence file error
12	0x00001000	45	Cam file error
13	0x00002000	46	Daughter board/Plugin watchdog error
14	0x00004000	47	Daughter board/Plugin error
15	0x00008000	48	Daughter board/Plugin error
16	0x00010000	49	Fieldbus SYNC cycle error
17	0x00020000	50	Fieldbus IP reference underflow/overflow
18	0x00040000	51	Fieldbus bus error (Node guarding, Heartbeat...)
19			
20	0x00100000	53	SD card error
21	0x00200000	54	File Erase/Write Error
22	0x00400000	55	Computation overflow
23	0x00800000	56	Safety channel 1 Error
24	0x01000000	57	User Program Error
25			
26			
27			
28	0x10000000	61	Encoder Commutation channel / Incremental channel Error
29	0x20000000	62	Encoder Absolute channel Error
30	0x40000000	63	User Program execution error
31	0x80000000	64	Procedure error (autotuning, autophasing...)

Warning Code

Index	0x3024
Name	Warning Code
Object Code	VAR
Data Type	Unsigned32
Object Class	all
Access	ro
PDO Mapping	Possible
Default Value	0

Bit	Mask	Function
0	0x00000001	STO active
9	0x00000200	Mains phase loss
10	0x00000400	IGBT module temperature
11		
12	0x00001000	Fan
13	0x00002000	Daughter board/Plugin software incompatible
14	0x00004000	Daughter board/Plugin hardware not ready
15	0x00008000	Daughter board/Plugin software not ready
16	0x00010000	Limit Switch
17		
18	0x00040000	I²t
19		
20		
21	0x00200000	Motor temperature
22		
23		
24	0x01000000	Position limit
25		
26		
27		
28	0x10000000	Absolute Encoder Initializing
29		
30	0x40000000	Motor phasing Init not ok
31		

Error Control

Index	0x3025
Name	Error control
Object Code	ARRAY
Number of Elements	3

Value Description

Sub Index	1
Description	Error mask 1
Data Type	Unsigned32
Object Class	all
Access	rw
PDO Mapping	No
Value	See 0x3022-1
Default value	No

Sub Index	2
Description	Error mask 2
Data Type	Unsigned32
Object Class	all
Access	rw
PDO Mapping	No
Value	See 0x3022-2
Default value	No

These 2 elements allow to mask the corresponding error.

3.2.1.3 - Stop Operation

With stop on speed ramp, the motor is slowed down in position loop with a slow down ramp.

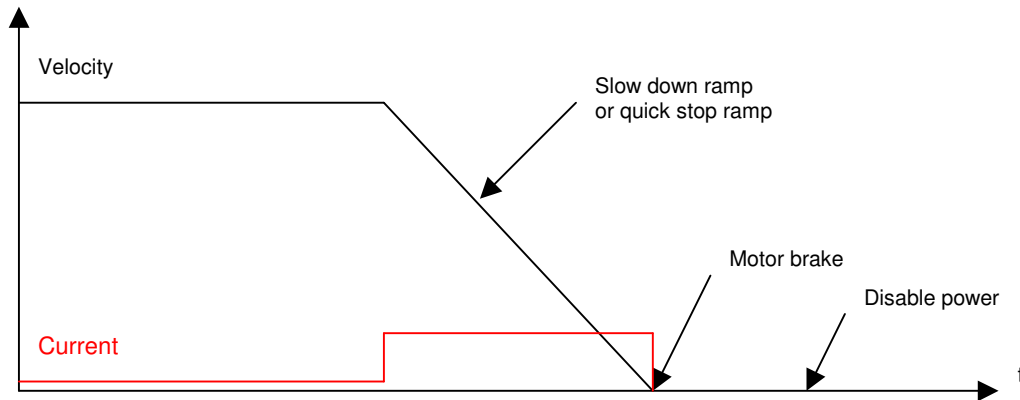

With stop on current limit, the motor is slowed down in velocity loop with a current limitation.

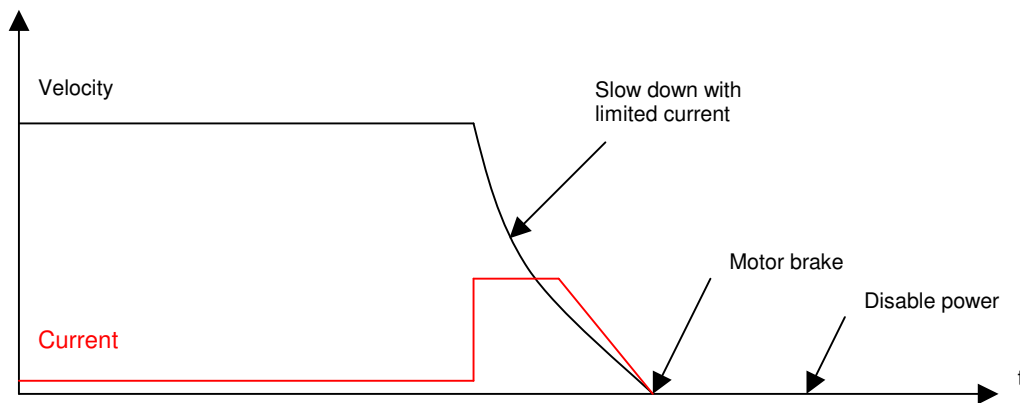

Stop option code	Action
0	Disable drive
1	Stopped on Slow down speed ramp and disabled
2	Stopped on Quick Stop speed ramp and disabled
3	Stopped on current limit and disabled
5	Stopped on Slow down speed ramp and stay in Quick Stop state
6	Stopped on Quick Stop speed ramp and stay in Quick Stop state
7	Stopped on current limit and disabled and stay in Quick Stop state

When a transition of the state machine occurs, a stop can be performed. These transition are:

- Quick Stop (transition 11)
- Disable Operation (transition 5)
- Shut down (transition 8)

Each transition can has a difference way to stop defined respectively in object 0x605A, 0x605C and 0c605B.

The Inhibit input stops the drive with parameter defined in object 0x305A.

Hardware limit switches stops with slow down speed ramp (with parameter in 0x3300,1)

- Stop on current limit uses the current limit value defined in object 0x3301,1
- Stop on slow down speed ramp uses the speed ramp defined in object 0x3300,1
- Stop on slow down speed ramp uses the speed ramp defined in object 0x6085,0

Object definitions

Index	Object	Name	Type	Attr.
0x605A	VAR	Quick Stop Option Code	Integer16	rw
0x605B	VAR	Shut down Option Code	Integer16	rw
0x605C	VAR	Disable Operation Option Code	Integer16	rw
0x305A	VAR	Inhibit Option Code	Integer16	rw
0x3300	ARRAY	Slow down ramp	Unsigned32	rw
0x6085	VAR	Quick Stop ramp	Unsigned32	rw
0x3301	ARRAY	Stop Current Limit	Integer16	rw
0x3302	ARRAY	Stop Time Limit	Unsigned16	rw
0x3304	VAR	Amplifier Reaction Time	Unsigned16	rw
0x3305	VAR	Motor Brake Reaction Time	Unsigned16	rw

Quick Stop Option Code

Index	0x605A
Name	Quick Stop Option Code
Object Code	VAR
Data Type	integer16
Object Class	all
Access	rw
PDO Mapping	No
Default Value	1

This object defines the stop behaviour when a QUICK_STOP command is executed (see Drive State Machine transition 11).

Quick stop option code	Action
0	Disable drive
1	Stopped on Slow down speed ramp and disabled
2	Stopped on Quick Stop speed ramp and disabled
3	Stopped on current limit and disabled
5	Stopped on Slow down speed ramp and stay in Quick Stop state
6	Stopped on Quick Stop speed ramp and stay in Quick Stop state
7	Stopped on current limit and disabled and stay in Quick Stop state

Shut Down Option Code

Index	0x605B
Name	Shut Down Option Code
Object Code	VAR
Data Type	integer16
Object Class	all
Access	rw
PDO Mapping	No
Default Value	0

This object defines the stop behaviour when a SHUTDOWN command is executed (see Drive State Machine transition 8).

Quick stop option code	Action
0	Disable operation
1	Stopped on Slow down speed ramp
2	Stopped on Quick Stop speed ramp
3	Stopped on current limit

Disable Operation Option Code

Index	0x605C
Name	Disable Operation Option Code
Object Code	VAR
Data Type	integer16
Object Class	all
Access	rw
PDO Mapping	No
Default Value	1

This object defines the stop behaviour when a DISABLE_OPERATION command is executed (see Drive State Machine transition 5).

Quick stop option code	Action
0	Disable operation
1	Stopped on Slow down speed ramp
2	Stopped on Quick Stop speed ramp
3	Stopped on current limit

Inhibit Option Code

Index	0x305A
Name	Inhibit Option Code
Object Code	VAR
Data Type	integer16
Object Class	all
Access	rw
PDO Mapping	No
Default Value	1

This object defines the stop behaviour when a Inhibit logic input is activated (see Digital Inputs 0x60FD).

Quick stop option code	Action
0	Disable drive
1	Stopped on Slow down speed ramp and disabled
2	Stopped on Quick Stop speed ramp and disabled
3	Stopped on current limit and disabled

Slow Down Ramp

Index	0x3300
Name	Slow Down Ramp
Object Code	ARRAY
Number of Elements	2

These parameters define the time limit for a stop operation.

When a stop on current limit is executed, the end of the stop may not be detected correctly if the axis is oscillating. The time stop limit allows to limit the execution time of the stop operation.

Value Description

Sub Index	1
Description	Slow Down Ramp 1
Data Type	Unsigned32
Object Class	all
Access	rw
PDO Mapping	No
Unit	Acceleration unit
Default Value	

These parameters define the slow down deceleration with a stop executed with stop option code = 1 or 5 (Stopped on Slow down ramp).

Sub Index	2
Description	Slow Down Ramp 2 reserved for future use.
Data Type	Unsigned32
Object Class	all
Access	rw
PDO Mapping	No
Unit	Acceleration unit
Default Value	

Quick Stop Ramp

Index	0x6085
Name	Quick Stop Ramp
Object Code	VAR
Data Type	Unsigned32
Object Class	all
Access	rw
PDO Mapping	No
Unit	Acceleration unit
Default Value	0x00200000

This object defines the deceleration for a quick stop with Quick Stop Option Code = 2 or 6 (Stopped on Quick Stop ramp).

Stop Current Limit

Index	0x3301
Name	Stop Current Limit
Object Code	ARRAY
Number of Elements	2

Value Description

Sub Index	1
Description	Stop Current Limit 1 This parameter defines the current limit when a stop on current limit is performed.
Data Type	Unsigned16
Object Class	all
Access	rw
PDO Mapping	No
Unit	per thousand of rated current
Value Range	100..6000
Default Value	1000

This parameter is used with a Quick Stop with Quick Stop Option Code = 3 or 7 (Stopped on current).
This parameter is also applied with a stop at limit switches.

Sub Index	2
Description	Stop Current Limit 2
Data Type	Unsigned16
Object Class	all
Access	rw
PDO Mapping	No
Unit	per thousand of rated current
Value Range	100..6000
Default Value	1000

This parameter is reserved for future use.

Stop Time Limit

Index	0x3302
Name	Stop Time Limit
Object Code	ARRAY
Number of Elements	2

These parameters define the time limit for a stop operation.

When a stop on current limit is executed, the end of the stop may not be detected correctly if the axis is oscillating. The time stop limit allows to limit the execution time of the stop operation.

Value Description

Sub Index	1
Description	Stop Time Limit 1 Time limit for all stop operations with ramp.
Data Type	Unsigned16
Object Class	all
Access	rw
PDO Mapping	No
Unit	ms
Value Range	0..65000
Default Value	1000

Sub Index	2
Description	Stop Time Limit 2 Time limit for all stop operations with current limit.
Data Type	Unsigned16
Object Class	all
Access	rw
PDO Mapping	No
Unit	ms
Value Range	0..65000
Default Value	1000

3.2.2 - DRIVE PARAMETERS

3.2.2.1 - Motor parameters

The motor parameters are stored in object 0x6410
These values are the parameters given in the motor manufacturer's catalogue.

The motor control parameters
 number of pole pairs (0x6410-13),
 motor phase (0x6410-14),
 motor offset (0x6410-15)

will be respectively copied in objects 0x3410-1, 0x3410-2 and 0x3410-3.

Object 0x3410 can be possibly modified and will be used for the motor control (i.e. if the resolver wiring or adjustment is not correct).

The auto-phasing procedure will calculate these parameters of object 0x3410.

The motor inductance parameter of the catalogue (0x6410-14) will be copied in object 0x340F-0 and will be used for calculating the current loop gains (0x60F6).

Object 0x340F-0 can be possibly modified before calculating the gains if inductances are serially mounted with the motor.

The Maximum Motor Speed (0x6410-7) parameter of the catalogue will clip the motor speed peaks in 0x6080.

Index	0x6410
Name	Motor Data
Object Code	RECORD
Object Class	all
Number of Elements	19

This object defines the motor manufacturer's motor data.

Value Description

Sub Index	1
Description	Motor Manufacturer Name
Data Type	String
Access	rw
PDO Mapping	No
Value	Maximum 30 characters

Sub Index	2
Description	Motor Model Name
Data Type	String
Access	rw
PDO Mapping	No
Value	Maximum 30 characters

Sub Index	3
Description	Motor Code Special code or personalisation code.
Data Type	String
Access	rw
PDO Mapping	No
Value	Maximum 30 characters

Sub Index	4
Description	Catalog Date Code
Data Type	Unsigned16
Access	rw
Object Class	all
PDO Mapping	No

The structure of the entries is the following:

MSB			LSB
Year (7-bit)	Month (4-bit)	Date (5-bit)	

Year is relative to 1984.

Sub Index	5
Description	Modification Date Code
Data Type	Unsigned16
Access	rw
PDO Mapping	No

Sub Index	6
Description	Motor Type
Data Type	Unsigned16
Access	rw
PDO Mapping	No
Value	0 Rotative 1 Linear

Sub Index	7
Description	Motor Max Speed
Data Type	Unsigned32
Access	rw
PDO Mapping	No
Unit	rpm

Sub Index	8
Description	Motor Rated Speed
Data Type	Unsigned32
Access	rw
PDO Mapping	No
Unit	rpm

Sub Index	9
Description	Motor Stall Current
Data Type	Unsigned32
Access	rw
PDO Mapping	No
Unit	mA

Sub Index	10
Description	Motor Peak Current
Data Type	Unsigned32
Access	rw
PDO Mapping	No
Unit	mA

Sub Index	11
Description	Torque Constant (Kt)
Data Type	Unsigned16
Access	rw
PDO Mapping	No
Unit	0.001Nm/A

Sub Index	12
Description	Inertia
Data Type	Unsigned16
Access	rw
PDO Mapping	No
Unit	0.001gm ²

Sub Index	13
Description	Inductance
Data Type	Unsigned16
Access	rw
PDO Mapping	No
Unit	0.1mH

Sub Index	14
Description	Number of motor pole pairs
Data Type	Unsigned16
Access	rw
PDO Mapping	No
Value	1..24

Sub Index	15
Description	Motor Phase
Data Type	Unsigned16
Access	rw
PDO Mapping	No
Value	0x5555 or 0xAAAA (corresponding to 240° or 120°)

Sub Index	16
Description	Motor Phasing
Data Type	Unsigned16
Access	rw
PDO Mapping	No
Value	

Index	0x3410
Name	Motor Control Parameters
Object Code	ARRAY
Object Class	all
Number of Elements	3

This object defines the parameters which control the motor.

Value Description

Sub Index	1
Description	Number of motor pole pairs
Data Type	Unsigned16
Access	rw
PDO Mapping	No
Value	1..24

Sub Index	2
Description	Motor Phase
Data Type	Unsigned16
Access	rw
PDO Mapping	No
Value	0x5555 (240°) 0xAAAA (120°)

Sub Index	3
Description	Motor Offset
Data Type	Unsigned16
Access	rw
PDO Mapping	No
Value	

Auto-phasing procedure

Index	0x3413
Name	Start Auto-phasing procedure
Object Code	
Data Type	Unsigned32
Object Class	all
Access	rw
PDO Mapping	No

In order to avoid running the auto-phasing procedure by mistake, the auto-phasing is only executed when a specific signature is written to this sub-index. The signature is 'apha'.
Signature = 0x61687061

Writing 0 to this object when auto- phasing is running will abort the procedure.

When reading, this object returns the operation status:

Read Value	Meaning
0	Procedure never executed
1	Can not execute
2	Procedure running
3	Procedure aborted by user
4	Procedure stopped on error
>= 5	Procedure done

When running, the BUSY bit of status word (0x6041) is set.

The auto-phasing procedure calculates these parameters:
 number of pole pairs 0x3410,1
 motor phase 0x3410,2
 motor offset 0x3410,3

Motor-phasing procedure

Index	0x3414
Name	Start Motor-phasing procedure
Object Code	
Data Type	Unsigned32
Object Class	all
Access	rw
PDO Mapping	No

In order to avoid running the motor-phasing procedure by mistake, the motor -phasing is only executed when a specific signature is written to this sub-index. The signature is 'mcal'.
 Signature = 0x6C61636D

Writing 0 to this object when motor-phasing is running will abort the procedure.

When reading, this object returns the operation status:

Read Value	Meaning
0	Procedure never executed
1	Can not execute
2	Procedure running
3	Procedure aborted by user
4	Procedure stopped on error
>= 5	Procedure done

When running, the BUSY bit of status word (0x6041) is set.

The motor-phasing procedure calculates these parameters: motor offset 0x3410,3

3.2.2.2 - Motor Brake

Servo On/Off Timing Diagram

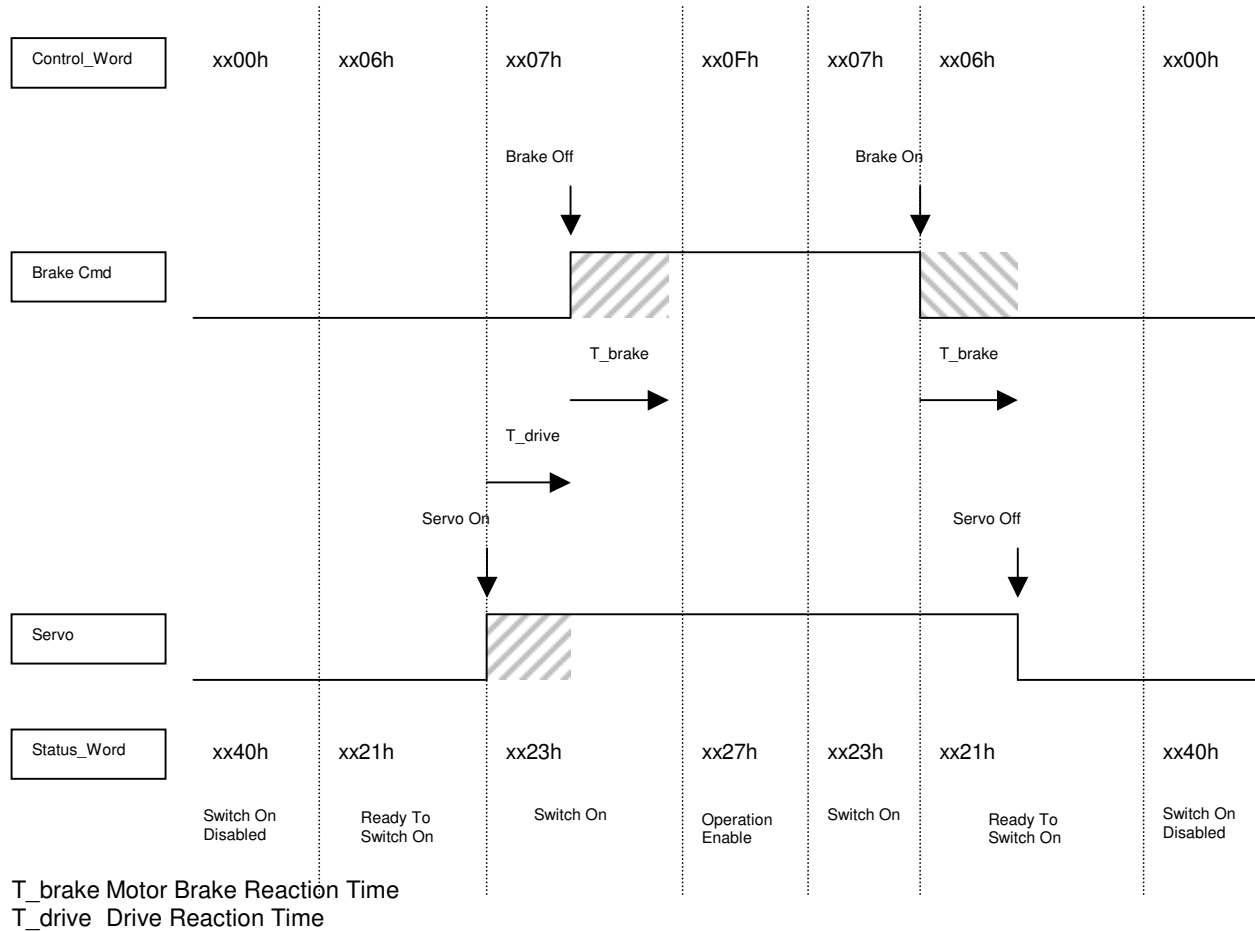

Index	Object	Name	Type	Attr.
0x3304	VAR	Amplifier Reaction Time	Unsigned16	rw
0x3305	VAR	Motor Brake Reaction Time	Unsigned16	rw

Note: The motor brake control is automatic with Switch On/Off by the control_word. To disable the motor brake control, it is necessary to set at 1 bit 0 of object 60FE sub-index 2 (digital output bitmask). The motor brake is then manually controlled by bit 0 of object 60FE sub-index 1.

Drive Reaction Time

Index	0x3304
Name	Drive Reaction Time
Object Code	VAR
Data Type	Unsigned16
Object Class	all
Access	rw
PDO Mapping	No
Unit	ms
Value Range	0..65535
Default Value	1

This parameter defines the reaction time of the drive when enabled / disabled.

Motor Brake Reaction Time

Index	0x3305
Name	Motor Brake Reaction Time
Object Code	VAR
Data Type	Unsigned16
Object Class	all
Access	rw
PDO Mapping	No
Unit	ms
Value Range	0..65535
Default Value	1

This parameter defines the reaction time of the motor brake.

3.2.2.3 - Motor current limits & Current Loop

The parameters defining the current limitation to be applied to the motor are the following:

- Motor Max Current 0x6073
- Motor Rated Current 0x6075

The motor parameters **Motor Max Current** (0x6410-8) and **Motor stall Current** (0x6410-9) will be used for calculating the internal limitations of the drive according to the drive maximum and rated currents (0x6510). The values of the drive internal limitations can be displayed by object 0x30F4.

The current loop gains are accessible in object 0x60F6.

Object 0x3411 allows:

- to calculate the current loop gains according to the motor parameters and the drive specifications:
 - Parameters:
 - Inductance (0x340F)
 - Drive Max current (0x6510-1)
 - Results:
 - Current Loop Gains (0x60F6)

Object 0x3412 allows:

- to calculate the drive current limitations according to the motor and drive currents (0x6510):
 - Parameters:
 - Motor Peak current (0x6410-10)
 - Motor Stall current (0x6410-9)
 - Drive Max current (0x6510-1)
 - Drive Rated current (0x6510-2)
 - Results:
 - Motor Max current (0x6073-0)
 - Motor Rated current (0x6075-0)

The input parameters must be previously defined.

Manufacturer Drive Data

Index	0x6510
Name	Manufacturer Drive Data
Object Code	ARRAY
Number of Elements	5

This object indicates the peak current and the rated current supported by the power module.

Value Description

Sub Index	1
Description	Drive Max Current gives the drive rating
Data Type	Unsigned32
Access	ro
PDO Mapping	No
Unit	mA

Sub Index	2
Description	Drive Rated Current gives the drive rated current
Data Type	Unsigned32
Access	ro
PDO Mapping	No
Unit	mA

Sub Index	3
Description	Drive Voltage gives the drive voltage
Data Type	Unsigned16
Access	ro
PDO Mapping	No
Unit	V

Sub Index	4
Description	Drive Service Voltage Defines the drive operating voltage
Data Type	Unsigned16
Access	rw
Backup	drive's parameter file
PDO Mapping	No
Unit	V
Value	Must be less than or equal to Drive Voltage (0x6510-3)

Sub Index	5
Description	Power Supply Voltage Threshold Defines the undervoltage error level.
Data Type	Unsigned16
Access	rw
Backup	drive's parameter file
PDO Mapping	No
Unit	V
min	20
max	100
Default value	100

Index	0x3411
Name	Current Loop Calculation
Object Code	VAR
Data Type	Unsigned32
Object Class	all
Access	rw
PDO Mapping	No
Default Value	0

When the motor inductance (0x6410) and drive current (0x6510) are correct, this object allows to calculate the current loop parameters.

In order to avoid this operation by mistake, the user must write a specific signature to this object to make the calculation.

The signature is 'calc'.

Signature = 0x636C6163

The parameters calculated are in object 0x60F6.

This procedure calculates also the current limit values (0x6073 and 0x6075)

Index	0x3412
Name	Current Limitation Calculation
Object Code	VAR
Data Type	Unsigned32
Object Class	all
Access	rw
PDO Mapping	No
Default Value	0

Signature = 0x636C6163

This procedure calculates the current limit values (0x6073 and 0x6075)

Index	0x6073
Name	Motor Max current
Object Code	VAR
Data Type	Integer16
Object Class	all
Access	rw
PDO Mapping	No
Unit	per thousand of rated current (0x6075)
Value Range	
Default Value	

This object defines the maximum current that the amplifier can deliver to the motor.

Index	0x6075
Name	Motor Rated Current
Object Code	VAR
Data Type	Integer32
Object Class	all
Access	rw
PDO Mapping	No
Unit	mA
Value Range	
Default Value	

This object defines the rated current that the amplifier can deliver to the motor.

Current Loop Parameters

This object defines the parameters of the current loops.

Index	0x60F6
Name	Current Loop Parameter Set
Object Code	RECORD
Number of Elements	5

Value Description

Sub Index	1
Description	Regulator Type
Data Type	Unsigned16
Object Class	pp ip hm pv eg
Access	rw
PDO Mapping	No
Value Range	0.. 65535
Default Value	0

Sub Index	2
Description	q-Loop Proportional Gain
Data Type	Unsigned16
Object Class	pp ip hm pv eg
Access	rw
PDO Mapping	No
Value Range	0.. 65535
Default Value	

Sub Index	3
Description	q-Loop Integral Gain
Data Type	Unsigned16
Object Class	pp ip hm pv eg
Access	rw
PDO Mapping	No
Value Range	0.. 65535
Default Value	

Sub Index	4
Description	d-Loop Proportional Gain
Data Type	Unsigned16
Object Class	pp ip hm pv eg
Access	rw
PDO Mapping	No
Value Range	0..65535
Default Value	

Sub Index	5
Description	d-Loop Integral Gain
Data Type	Unsigned16
Object Class	pp ip hm pv eg
Access	rw
PDO Mapping	No
Value Range	0.. 65535
Default Value	

3.2.2.4 - Dynamic current limits

The current applied to the motor is dynamically limited by the value of a defined object. By default, object 0x30D1 is used to limit the motor current (defined in 0x30DA).

The default value of object 0x30D1 is 0x3FFF and corresponds to the maximum current setting by the user (0x6073).

Dynamic Current Limit Input Source

Index	0x30DA
Name	Dynamic Current Limit Input Source
Description	Index/sub-index of input data
Data Type	Unsigned32
Object Class	all
Access	rw
PDO Mapping	No
Default Value	0x30D10000
Value	See below

This object allows to connect any dataflow as the source of the Dynamic Current Limit.

By default the object 0x30D1 is used as Dynamic Current Limit signal.

The structure of the entries is the following:

MSB	LSB
Index (16-bit)	Sub-index (8-bit) 0

Current Limit

Index	0x30D1
Name	Current Limit
Description	This object allows to limit the current dynamically applied to the motor. Changes on this object will be continuously effective.
Data Type	integer16
Object Class	all
Access	rw
PDO Mapping	Yes
Default Value	0x3FFF
Value	0-0x3FFF 0x3FFF corresponds to the maximum value setting (0x6073) for maximum current in the motor

Dynamic Current Limit Configuration

Index	0x30D2	
Name	Dynamic Current Limit Configuration	
Description	This object allows to define the effect of Dynamic Current Limit signal.	
Data Type	Unsigned16	
Object Class	all	
Access	rw	
PDO Mapping	No	
Default Value	0	
Value	bit	description
	0	0 normal effect of the Dynamic Current Limit signal: 0 current is limited to 0 0x3FFF corresponds to the maximum current (0x6073)
	1	reverse effect of the Dynamic Current Limit signal 0x3FFF current is limited to 0 0 corresponds to the maximum current (0x6073)
	1..15	reserved

Current Monitor

Index	0x30D4
Name	Current monitor
Object Code	VAR
Data Type	Integer16
Object Class	all
Access	ro
PDO Mapping	Yes
Unit	of drive max current (0x6510) (0x3FFF = 100% I _{max})
Value Range	-
Default Value	-

3.2.2.5 - Motor temperature probe

Index	0x3324
Name	Motor temperature probe configuration
Object Code	RECORD
Object Class	all
Number of Elements	3

This object defines Motor temperature probe configuration.

Value Description

Sub Index	1
Description	Motor temperature type
Data Type	Integer16
Access	rw
PDO Mapping	No
Value	-1 NTC probe 1 PTC probe 0 No probe

Sub Index	2
Description	Motor temperature warning threshold
Data Type	Unsigned32
Access	rw
PDO Mapping	No
Unit	Ω (ohm)
Default value	2400

This parameter defines the threshold of the equivalent resistor corresponding to the temperature at which a warning will be notified.

Sub Index	3
Description	Motor temperature error threshold
Data Type	Unsigned32
Access	rw
PDO Mapping	No
Unit	Ω (ohm)
Default value	2400

This parameter defines the threshold of the equivalent resistor corresponding to the temperature at which an error will be triggered.

Index	0x3323
Name	Motor temperature probe monitoring
Object Code	VAR
Data Type	Unsigned32
Object Class	all
Access	ro
Unit	Ω (ohm)
PDO Mapping	No

The returned value gives an image of the equivalent resistance (in Ω).

3.2.2.6 - Sensors

The ServoPac servo drive has 2 sensor inputs: Resolver and Encoder

Each sensor can be used as motor feedback or position feedback.

Index	Object	Name	Type	Attr.
0x306A	VAR	Position Feedback Sensor Select	Unsigned16	rw
0x3070	VAR	Motor Feedback Sensor Select	Unsigned16	rw

Position Feedback Sensor Select

Index	0x306A
Name	Position Feedback Sensor Select
Object Code	VAR
Data Type	Unsigned16
Object Class	all
Access	rw
PDO Mapping	No
Default Value	0

This object defines the feedback sensor which will be used to close the position loop.

Value	Function
0	Resolver Feedback
1	Encoder Feedback

When motor feedback and position feedback are different (resolver for motor feedback and encoder for position feedback, for example), both sensors must count in the same direction.

Motor Feedback Sensor Select

Index	0x3070
Name	Motor Feedback Sensor Select
Object Code	VAR
Data Type	Unsigned16
Object Class	all
Access	rw
PDO Mapping	No
Default Value	0

The motor feedback sensor is used to close the servo motor torque and speed control loops. The servo motor position loop can be closed by the motor feedback sensor or with the secondary sensor (see object 0x306A).

Value	Function
0	Resolver Feedback
1	Encoder Feedback

3.2.2.6.1 - Resolver

Resolver Parameters

Index	Sub	Name	Description	Type	Attribute
0x3100		Resolver	Resolver monitoring		
	1	Res_Sin		Integer16	ro
	2	Res_Cos		Integer16	ro
	3	Res_Amp2		Unsigned16	ro
	4	Res_Mod		Unsigned16	ro
	5	Res_Amp		Unsigned16	ro
0x3101		Res_Setp	Resolver Setup		
	1	Res_Type			rw
	2	Res_Cfg			rw
	3	Res_Zsh			rw
	4	Res_Zsz			rw
	5	Res_NP			rw
0x3102		Res_Err	Resolver Error control		
	1	Res_Thrs		Unsigned16	rw
	2	Res_Lim		Unsigned16	rw
	3	Res_AmpF		Unsigned16	rw
	4	Res_Rdc		Unsigned32	rw
	5	Res_Filt		Unsigned16	rw
0x3104		Res_Cal	Resolver Calibration procedure		
0x3105		Res_CalV	Resolver Calibration parameters		
0x3107	0	Res_TopZ	Resolver Virtual Top Z	Unsigned16	ro
0x3108	0	Res_ofs	Resolver Offset (user position unit)	Integer32	rw
0x3109	0	Res_pos	Resolver Position (user position unit)	Integer32	ro
0x310A	0	Res_vel	Resolver Velocity (user velocity unit)	Integer32	ro
0x310C	0	Res_raw	Resolver raw position	Integer32	ro

Resolver Setup

Index	0x3101
Name	Resolver Setup
Object Code	RECORD
Number of Elements	6

Value Description

Sub Index	1
Description	Resolver Type
Data Type	Unsigned16
Object Class	all
Access	rw
PDO Mapping	No
Default Value	0

Bit Number	Description
0	1 Enabled

Sub Index	2
Description	Resolver Configuration
Data Type	Unsigned16
Object Class	all
Access	rw
PDO Mapping	No
Default Value	0

Bit Number	Description
0	0 Normal direction 1 Reverse direction

Sub Index	3
Description	Resolver Virtual Top Z shift
Data Type	Unsigned16
Object Class	all
Access	rw
PDO Mapping	No
Default Value	0

This parameter defines the offset between marker Z of the encoder and the virtual marker Z.
The value is given in encoder increments (4096 increments / revolution).

Sub Index	4
Description	Resolver Virtual Top Z size
Data Type	Unsigned16
Object Class	all
Access	rw
PDO Mapping	No
Default Value	0

This parameter defines the width of the virtual marker Z.
The value is given in encoder increments (4096 increments / revolution).

The virtual marker Z is working with polling technique, the width of the virtual marker Z allows to increase the marker Z size in order to avoid a missing of the marker Z.

The status of the virtual marker Z can be read by object 0x3027

Sub Index	5
Description	Resolver Pole pairs
Data Type	Unsigned16
Object Class	all
Access	rw
PDO Mapping	No
Default Value	1

Resolver Position Offset

Index	0x3108
Name	Resolver Position Offset
Object Code	VAR
Data Type	Integer32
Object Class	all
Access	rw
PDO Mapping	Yes
Unit	User Position Unit
Value Range	$(-2^{31})..(2^{31}-1)$
Default Value	0

See Resolver Position (0x3109).

Resolver Position

Index	0x3109
Name	Resolver Position
Object Code	VAR
Data Type	Integer32
Object Class	all
Access	ro
PDO Mapping	Yes
Unit	User Position Unit
Value Range	$(-2^{31})..(2^{31}-1)$
Default Value	-

This object monitors the resolver position:

$$\text{Resolver_Position} = \text{Resolver_Internal_Position} + \text{Resolver_Position_Offset}$$

Resolver_Position (0x3109) in user position unit is the position given by the resolver. If the position loop feedback is resolver, and the modulo function (Position Limit) is not activated, then the resolver position is the same as 0x6064.

Resolver_Internal_Position in user position unit is the resolver position value related to the initial position at power on.

Resolver_Position_Offset (0x3108) defines an offset between user position (0x3109) and internal resolver position. If the position loop feedback is resolver, this offset will be calculated by the homing procedure. At power on Resolver_Position_Offset is 0.

3.2.2.6.2 - Encoder

Encoder support types:

- TTL Incremental Encoder
- TTL Incremental Encoder + Hall Effect Sensor
- Sin-Cos Incremental Encoder
- Sin-Cos Incremental Encoder + Hall Effect Sensor
- Hiperface Encoder

Encoder Parameters

Index	Sub	Name	Description	Type	Attribute
0x3120		Encoder1	Encoder 1		
	1	Enc1Sin		Integer16	ro
	2	Enc1Cos		Integer16	ro
	3	Enc1Amp2		Integer16	ro
	4	Enc1Mod		Unsigned16	ro
	5	Enc1Amp		Integer16	ro
0x3121		Enc1Setp	Encoder 1 Setup		
0x3122		Enc1Err	Encoder 1 Error Control		
	1	Enc1Cnt		Unsigned32	rw
	2	Enc1Thrs		Unsigned16	rw
	3	Enc1Lim		Unsigned16	rw
	4	Enc1Zlim		Unsigned16	rw
	5	Enc1Clim		Unsigned16	rw
	6	Enc1Vlim		Unsigned32	rw
0x3124		Enc1CalP	Encoder 1 Calibration		
0x3127	0	Enc1TopZ	Encoder 1 Virtual Top Z	Unsigned16	ro
0x3128	0	Enc1ofs	Encoder 1 Offset (user position unit)	Integer32	rw
0x3129	0	Enc1pos	Encoder 1 Position (user position unit)	Integer32	ro
0x312A	0	Enc1vel	Encoder 1 Velocity (user velocity unit)	Integer32	ro
0x312C	0	Enc1raw	Encoder1 Raw Position	Integer32	ro

Encoder Setup

Index	0x3121
Name	Encoder Setup
Object Code	RECORD
Number of Elements	6

Value Description

Sub Index	1
Description	Encoder Type
Data Type	Unsigned16
Object Class	all
Access	rw
PDO Mapping	No
Default Value	

Bit Number	Description
0	1 Enabled 0
1	1 TTL Encoder 0
2	1 Sin/Cos Encoder 0
3	1 Encoder with CD track 0
4	1 HES 0
5	0 HAL 60° 1 HAL 120°
6	Absolute Single-turn
7	Absolute Multi-turn
8	Reverse Incremental track / Absolute track
12-15	Communication Protocol 1 Hiperface

Sub Index	2
Description	Encoder Configuration
Data Type	Unsigned16
Object Class	all
Access	rw
PDO Mapping	No
Default Value	

Bit Number	Description
0	0 Normal direction 1 Reverse direction

Sub Index	3
Description	Encoder Virtual Top Z shift
Data Type	Unsigned16
Object Class	all
Access	rw
PDO Mapping	No
Default Value	0

This parameter defines the offset between the marker Z of the encoder and the virtual marker Z.
The value is given in encoder increments (encoder resolution x 4)

Sub Index	4
Description	Encoder Virtual Top Z size
Data Type	Unsigned16
Object Class	all
Access	rw
PDO Mapping	No
Default Value	0

This parameter defines the width of the virtual marker Z.
The value is given in encoder increments (encoder resolution x 4).

The virtual marker Z is working with polling technique, the width of the virtual marker Z allows to increase the marker Z size in order to avoid the missing of the marker Z.

The status of the virtual marker Z can be read by object 0x3127.

Sub Index	5
Description	Encoder Resolution x 4
Data Type	Unsigned32
Object Class	all
Access	rw
PDO Mapping	No
Default Value	

This parameter defines the resolution (period) of the encoder x 4.

Encoder Position Offset

Index	0x3128
Name	Encoder Position Offset
Object Code	VAR
Data Type	Integer32
Object Class	all
Access	rw
PDO Mapping	Yes
Unit	User Position Unit
Value Range	$(-2^{31})..(2^{31}-1)$
Default Value	0

See Encoder Position (0x3129).

Encoder Position

Index	0x3129
Name	Encoder Position
Object Code	VAR
Data Type	Integer32
Object Class	all
Access	ro
PDO Mapping	Yes
Unit	User Position Unit
Value Range	$(-2^{31})..(2^{31}-1)$
Default Value	-

This object monitors the encoder position:

$$\text{Encoder_Position} = \text{Encoder_Internal_Position} + \text{Encoder_Position_Offset}$$

Encoder _Position (0x3109) in user position unit is the position given by the encoder. If the position loop feedback is encoder and modulo function (Position Limit) is not activated, then the encoder position is the same as 0x6064.

Encoder_Internal_Position in user position unit, is the encoder position value related to the initial position at power on.

Encoder_Position_Offset (0x3128) defines an offset between user position (0x3129) and internal encoder position. If the position loop feedback is encoder, this offset will be calculated by the homing procedure. At power on Encoder_Position_Offset is 0.

3.2.2.6.3 - TTL Encoder

An TTL incremental encoder can be connected to the ServoPac drive as motor feedback or only position feedback.

Motor Feedback:

TTL incremental encoder is not absolute for motor commutation, so:

- In the first time, an auto-phasing must be performed to define motor poles pairs number, motor phase order, and encoder offset.

- Each time drive is restart with 24V, a motor-phasing must be performed before motor can be controlled.

Note:

- motor-phasing applies torque and moves motor
- power supply must be on
- please check that motor is at standstill and its movement over one turn not dangerous for operator and machine.
- motor-phasing does not work with vertical axis or axis with driving load.

Position Feedback:

If the encoder is used as position feedback only (motor feedback is resolver) then the encoder resolution defined in object 0x608F must be the encoder counts for one motor revolution.

3.2.2.6.4 - Sin-Cos Encoder

A Sin-Cos incremental encoder can be used with ServoPac drive as an TTL incremental encoder.

An internal Sin-Cos interpolation allows the drive working in higher resolution and so better result for speed loop.

3.2.2.6.5 - Hall Effect Sensor

The hall effect sensor can be used with a TTL incremental encoder or a sin-cos incremental encoder to avoid a motor phase search with motor-phasing operation each time the 24V is applied.

The hall effect sensor parameters are calculated with the auto-phasing procedure.

Parameters depending on hall effect sensor:

- Motor phase order: 0x3410,2
- Sensor offset: 0x3410,3
- Hall effect sensor parameter: 0x313E,0

Index	Object	Name	Type	Attr.
0x313E	VAR	HES configuration	Unsigned16	rw

Hall Effect Sensor configuration

Index	0x313E
Name	Encoder HES configuration
Description	Encoder Type
Data Type	Unsigned16
Object Class	all
Access	rw
PDO Mapping	No
Saved	Yes
Default Value	0

Value Description

Bit Number	Description
0-2	HES initial state
3	Direction
4	Type: 0 60° 1 120°

Manual Configuration for an incremental encoder + HES:

0x3121,1 = 0x0013 ; incremental TTL encoder + HES

0x313E,0 = HES config

0x3410,1 = pole pairs

0x3410,2 = phase order

0x3410,3 = sensor offset (mechanic)

3.2.2.6.6 - Hiperface

A Hiperface encoder type can be connected to an ServoPac drive.
Only Hiperface Encoder type different from 0xFF can be recognized.

Setup Hiperface encoder with Gem Drive Studio

The Hiperface Encoder commissioning can be done with Gem Drive Studio:

- Select Hiperface Encoder
- Check "Enable encoder input"
- "Read Encoder Configuration" to read encoder parameters
- "Apply"

Move the motor by hand, if there is an "Encoder Commutation channel / Incremental channel Error" then toggle "Reverse Incremental Track".

Setup Hiperface encoder manually

Enable and select Hiperface encoder are defined with object 0x3121,1

Writing a 1 to object 0x312B,1 allows to read Hiperface encoder parameters.

The Hiperface encoder has an absolute information track (serial) and an incremental information track (Sin-Cos). Both information tracks must evolve in the same direction. An inverting of Sin-Cos signals can change the counting direction of Sin-Cos signal regarding the absolute value from serial channel.

If there is an "Encoder Commutation channel / Incremental channel Error" when moving the encoder (motor), then "Reverse Incremental track / Absolute track" bit in object 0x3121,1 must be toggled.

3.2.2.6.7 - Absolute Multi-turn Position

With an absolute encoder feedback, the motor absolute position value over one revolution is available and the servo motor can immediately be enabled after the amplifier power up. The servo drive behaviour at the amplifier power up is similar to a resolver sensor feedback. For a position application, an absolute multi-turn encoder allows to avoid the homing sequence after power up. In this case, the absolute position value over the axis travel range is available at power up and the positioning can be immediately started. However, the axis must never go out of encoder's absolute position range.

Setting Encoder Zero

The absolute encoder gives a position value between 0 and a max. position value (depending on the encoder model).

For a Hiperface encoder, the max. position value is given by:

$$(\text{Number_of_revolutions} \times \text{Number_of_periods} \times 4 \times 8) - 1$$

Number_of_revolutions is the maximum revolution for that encoder.

Number_of_periods is the the number of Sin-Cos periods per revolution

4 is quadrature counter multiplier

8 is the interpolation factor.

Example 1:

Number_of_revolutions = 4096

Number_of_periods = 1024

Then the maximum position value given by the encoder is $4096 \times 1024 \times 4 \times 8 - 1 = 134\,217\,727 = 0x7FF\,FFF$

Once the encoder parameters set, this maximum position can be read with object 0x312D,1.

The current position of the encoder is given by object 0x312D,3

Note: these values are in encoder unit.

As the encoder gives only a position between 0 and encoder max. value, an Encoder Zero Position can be defined for a convenient operation:

- always positive value,
- or always negative value,
- or bipolar value

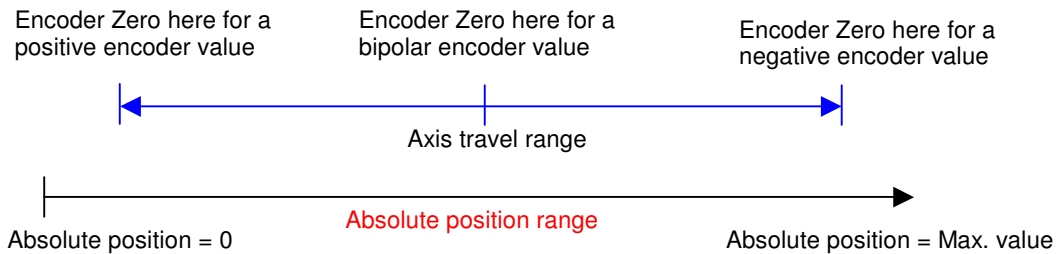

The object 0x312B,1 allows to set the Encoder Zero at the current position:

- Place the motor at the desired Encoder Zero Position,
- drive must be disabled,
- write 0x312B,1=0x73626165
- save parameters into drive

The encoder offset is given in object 0x312D,5 (encoder unit) which must be stored in the parameter file.

The Encoder Zero Position can be defined manually:

- drive is disabled,
- write offset value to 0x312D,5
- save parameters into drive
- restart 24V to apply this offset.

Example 2:

Set 0x312D,5 = 0x400 0000, so Encoder Zero Position is set in middle of absolute position range, The absolute encoder value will be from $-(Max_value+1)/2$ to $(Max_value+1)/2-1$

User Datum

The user position reference related to the mechanical machine can be defined with a homing operation as usual. The encoder position offset from homing operation can be read with object 0x3128,0. After homing operation, parameters need to be saved (object 0x3128,0 is saved in the parameter file). This operation needs to be done only once in the machine life-time.

The encoder position in user unit is defined by the relation below:
 $[0x3129,0] = [0x3130,0] + [0x3128,0] - user_unit([0x312D,5])$

0x3129,0 and 0x3130,0 and 0x3128,0 are in user unit, 0x312D,5 is in encoder unit.

If the position feedback is encoder, then [0x6064,0] is the same as [0x3129,0].

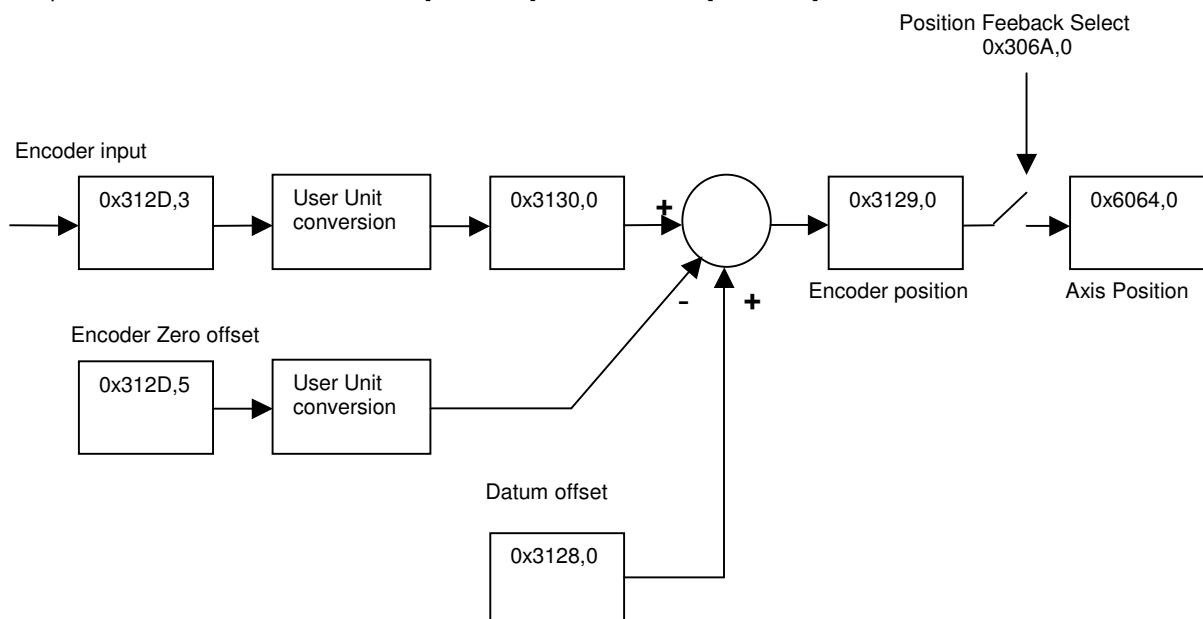

3.2.2.7 - Factor and units

Factor and Units

The position unit is defined by object 0x6093

The velocity unit is defined by position unit per second.

The acceleration unit is defined by position unit per square second.

Index	Object	Name	Type	Attr.
0x608F	ARRAY	Encoder Position Resolution	Unsigned32	rw
0x6093	ARRAY	Position Factor	Unsigned32	rw
0x3089	VAR	Position Display Factor	Unsigned16	rw
0x308A	VAR	Position Unit Name	String	rw

Index	0x608F
Name	Encoder Position Resolution
Object Code	ARRAY
Number of Elements	2

Value Description

Sub Index	1
Description	Encoder Increments
Data Type	Unsigned32
Object Class	all
Access	rw
PDO Mapping	No
Unit	inc
Value Range	
Default Value	0x1000

This parameter defines the encoder position resolution for one motor revolution.

Sub Index	2
Description	Motor Revolutions
Data Type	Unsigned32
Access	ro
PDO Mapping	No
Default Value	1

Position Factor

Index	0x6093
Name	Position Factor
Object Code	ARRAY
Number of Elements	2

Value Description

Sub Index	1
Description	Position Factor Numerator
Data Type	Unsigned32
Object Class	all
Access	rw
PDO Mapping	No
Default Value	4096

Sub Index	2
Description	Position Factor Denominator
Data Type	Unsigned32
Object Class	all
Access	rw
PDO Mapping	No
Default Value	4096

The Denominator defines the increments in user unit for one motor revolution.

The Numerator defines the increments in motor unit for one motor revolution. This value must be set to 4096.

$$\text{Motor_position} = \text{Numerator} / \text{Denominator} * \text{User_position}$$

Example:

1 motor revolution corresponds to a displacement of 5 mm on the load.
 The desired user resolution is μm .
 Setting parameters:
 Numerator = 4096
 Denominator = 5000
 User unit = μm

3.2.2.8 - Servo Loops

SERVO CONTROLLER STRUCTURE

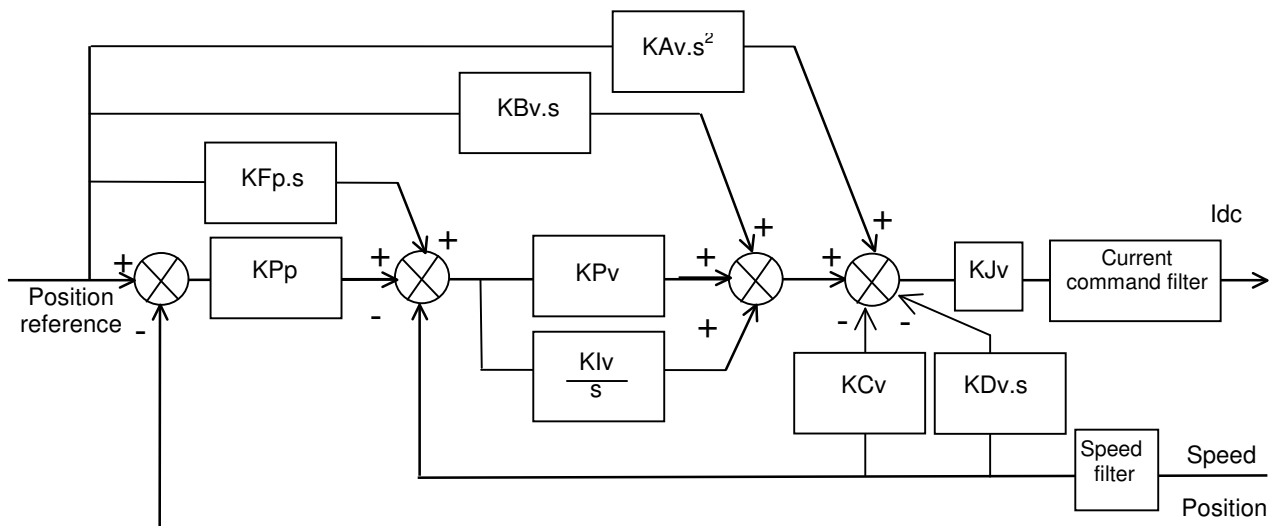

Speed loop gains are the most critical adjust because they greatly depend on the mechanical load characteristics (inertias, frictions, coupling stiffness, resonances,...).

- **Proportional speed gain (KPv):** defines the proportional gain of the controller which acts on the speed error. The higher this parameter value, the faster the speed loop response.

- **Integral speed gain (Klv)**: defines the integral gain of the controller which acts on the speed error. The higher this parameter value, the better the axis stiffness.
- **Integrator low frequency limit (Klvf in Hz)**: defines the low frequency value from where the controller integrator term is saturated. This parameter is used for reducing the motor heating in applications with large dry frictions due to the mechanical load.
- **Damping gain (KCv)**: defines the proportional gain of the controller which acts only on the speed feedback. This parameter allows to reduce the speed loop overshoot in response to a step like set point change .
- **Derivative speed gain (KDv)**: defines the derivative gain of the controller which acts on the speed error.
- **Derivator high frequency limit (KDvf in Hz)**: defines the high frequency value from which the controller derivative term is saturated.
- **Gain scaling factor (KJv)**: defines a multiplying factor for all speed regulator gains. This parameter is scaling the speed regulator gains in order to avoid any saturation when large values are required. This parameter allows also to adjust the servo loop stability in case of load inertia changes.

The **Current command filter** is a 3rd order, low pass type, with 3 adjustable cut-off frequencies. Each cut-off frequency value can be freely adjusted according to the application for the filtering of high frequency noise or the filtering of mechanical resonances.

The **Speed measurement filter** is a 1st order, low pass type, with 3 selectable time constant values. The higher the time constant value, the lower the speed measurement noise, but also the lower the speed loop gains because of the increased speed measurement delay. The **Speed measurement filter** time constant is selected according to the motor position sensor resolution and the acceptable noise level in the speed measurement.

Position loop gains influence mainly the servo motor behaviour during the displacements (following error, position overshoot, audible noise, ...).

- **Proportional position gain(KPp)**: defines the proportional gain of the controller which acts on the position error. The higher this parameter value, the better the axis stiffness and the lower the following error.
- **Feedforward speed 1 gain(KFp)**: defines the feedforward speed amplitude corresponding to the speed input command. This term allows to reduce the following error during the motor displacement. Its value is set to the max (65536) after the autotuning procedure if a following error as small as possible is required.
- **Feedforward speed 2 gain(KBv)**: defines the feedforward speed amplitude corresponding to the viscous frictions. This term allows to reduce the viscous friction effect during the motor displacement. The gain value is equal to the damping gain value + the viscous friction compensation term. After the autotuning procedure, the feedforward speed 2 gain is set equal to the damping gain value if a following error as small as possible is required. The viscous friction compensation term can be calculated by measuring the current/speed ratio at various motor speed values.
- **Feedforward acceleration gain(KAv)**: defines the feedforward acceleration amplitude corresponding to the acceleration input command. This term allows to reduce the following error during the motor acceleration and deceleration phases. Its value is calculated by the amplifier during the auto-tuning procedure if a following error as small as possible is required.

When the **autotuning** procedure is executed, the motor + mechanical load specifications are identified and the appropriate gain values are calculated according to the requirements selected by the user (controller type, filter type, bandwidth value, ...). All gain values can then be modified manually by the user if required.

The choice of the time interval for speed measurement (speed measurement filter) allows to select the speed measurement resolution value according to the position sensor resolution value:

$$\text{speed resolution (rpm)} = 60000 / \text{position sensor resolution (ppr)} / \text{time interval (ms)}.$$

The higher the time interval value, the better the resolution, but also the lower the servo loop gains because of the increased speed measurement delay.

The choice of the anti-resonance filter is necessary in case of loud noise in the motor due to the motor/load coupling elasticity.

The choice of the maximum stiffness filter allows to get the maximum stiffness on the motor shaft with regard to the torque disturbances. However, this choice is only possible without any resonance due to the motor/load coupling elasticity.

The choice of the speed loop bandwidth defines the cut-off frequency value of the closed loop frequency response (Low = 50 Hz, Medium = 75 Hz, High = 100 Hz).

The choice “**minimum following error**” allows to get an accurate following of the position reference value during the entire motor displacement. In this case, all feedforward gain values are calculated.

The choice “**minimum position overshoot**” allows to get a motor positioning without any overshoot of the target position. In this case, all the feedforward gain values are set at 0, and the motor position is lagging with regard to the position reference value during the whole motor displacement.

Velocity Control Parameter Set

This object defines the parameters of the current loops.

Index	0x60F9
Name	Velocity Control Parameter Set
Object Code	RECORD
Number of Elements	8

Value Description

Sub Index	1
Description	Regulator Type
Data Type	Unsigned16
Object Class	pp ip hm pv eg
Access	rw
PDO Mapping	No
Value Range	0..65535
Default Value	0

Sub Index	2
Description	Proportional Speed Gain Defines the proportional regulator gain (K _{Pv}) that acts upon the speed error.
Data Type	Unsigned16
Object Class	pp ip hm pv eg
Access	rw
PDO Mapping	No
Value Range	0..65535
Default Value	

Sub Index	3
Description	Integral Speed Gain Defines the integral regulator gain (K _{Iv}) that acts upon the speed error.
Data Type	Unsigned16
Object Class	pp ip hm pv eg
Access	rw
PDO Mapping	No
Value Range	0.. 65535
Default Value	

Sub Index	4
Description	Integral Gain Filter
Data Type	Unsigned16
Object Class	pp ip hm pv eg
Access	rw
PDO Mapping	No
Unit	0.1 Hz
Default Value	

Sub Index	5
Description	Damping Gain (Kc) This gain is used for getting the maximum servo loop stiffness.
Data Type	Unsigned16
Object Class	pp ip hm pv eg
Access	rw
PDO Mapping	No
Value Range	0.. 65535
Default Value	

Sub Index	6
Description	Derivative Gain (KD)
Data Type	Unsigned16
Object Class	pp ip hm pv eg
Access	rw
PDO Mapping	No
Value Range	0.. 65535
Default Value	

Sub Index	7
Description	Derivative Gain Filter
Data Type	Unsigned16
Object Class	pp ip hm pv eg
Access	rw
PDO Mapping	No
Unit	Hz
Default Value	

Sub Index	8
Description	KJv
Data Type	Unsigned16
Object Class	pp ip hm pv eg
Access	rw
PDO Mapping	No
Value Range	0.. 65535
Default Value	

Speed Error Low-pass Filter

Index	0x30F9
Name	Speed Loop Low-pass filter Defines the cut-off frequency at -3 dB (Fev) of the first order filter that acts upon the current control. The value of this parameter is depending on the selected bandwidth.
Object Code	ARRAY
Number of Elements	3

Value Description

Sub Index	1
Description	Speed Loop Low-pass filter 1
Data Type	Unsigned16
Object Class	pp ip hm pv eg
Access	rw
PDO Mapping	No
Unit	Hz
Value Range	20..1000Hz 0 not active
Default Value	

Sub Index	2
Description	Speed Loop Low-pass filter 2
Data Type	Unsigned16
Object Class	pp ip hm pv eg
Access	rw
PDO Mapping	No
Unit	Hz
Value Range	20..1000Hz 0 not active
Default Value	

Sub Index	3
Description	Speed Loop Low-pass filter 3
Data Type	Unsigned16
Object Class	pp ip hm pv eg
Access	rw
PDO Mapping	No
Unit	Hz
Value Range	20..1000Hz 0 not active
Default Value	

Position Control Parameter Set

Index	0x60FB
Name	Position Control Parameter Set
Object Code	RECORD
Number of Elements	5

Value Description

Sub Index	1
Description	Regulator Type
Data Type	Unsigned16
Object Class	pp ip hm eg
Access	rw
PDO Mapping	No
Default Value	0

Sub Index	2
Description	Proportional Position Gain Defines the proportional gain that acts upon the position error (KP1).
Data Type	Unsigned16
Object Class	pp ip hm eg
Access	rw
PDO Mapping	No
Value Range	0..65535
Default Value	

Sub Index	3
Description	Feedforward Speed 1 Gain Defines the feedforward term amplitude (KF1) corresponding to the speed input command (derivation of the position input command). This feedforward term allows to reduce the following error during the motor acceleration and deceleration phases.
Data Type	Unsigned16
Object Class	pp ip hm eg
Access	rw
PDO Mapping	No
Value Range	0.. 65535
Default Value	

Sub Index	4
Description	Feedforward Acceleration Gain Defines the feedforward acceleration corresponding to the acceleration input command (second derivation of the position input command). This feedforward term allows to reduce the following error during the motor acceleration and deceleration phases.
Data Type	Unsigned16
Object Class	pp ip hm eg
Access	rw
PDO Mapping	No
Value Range	0.. 65535
Default Value	

Sub Index	5
Description	Feedforward Speed 2 Gain This gain value is equal to the damping speed gain value +Feedforward friction gain value. The feedforward friction gain allows to cancel the load viscous friction effect (load viscous friction torque is proportional to axis speed). This feedforward term allows to reduce the following error during the motor acceleration and deceleration phases.
Data Type	Unsigned16
Object Class	pp ip hm eg
Access	rw
PDO Mapping	No
Value Range	0.. 65535
Default Value	

Auto-tuning Parameters

Index	0x3425
Name	Auto-tuning parameters
Object Code	ARRAY
Number of Elements	4

Value Description

All these parameters must be set before starting the auto-tuning by 0x3426.

Sub Index	1
Description	Auto-tuning Bandwidth
Data Type	Unsigned16
Object Class	-
Access	rw
PDO Mapping	No
Value Range	0..2
Default Value	

This parameter defines the auto-tuning bandwidth:

Value	Bandwidth
0	Low Bandwidth
1	Medium Bandwidth
2	High Bandwidth

Sub Index	2
Description	Filter type
Data Type	Unsigned16
Object Class	-
Access	rw
PDO Mapping	No
Value Range	0..2
Default Value	

This parameter defines the auto-tuning filter:

Value	Filter
0	Standard filter
1	Anti-resonance filter
2	High stiffness filter

Sub Index	3
Description	Speed Filter
Data Type	Unsigned16
Object Class	-
Access	rw
PDO Mapping	No
Value Range	0..2
Default Value	

This parameter defines the speed filter:

Value	Filter
0	auto-select by auto-tuning
1	0.5ms
2	1ms
3	2ms

Sub Index	4
Description	Auto-tuning Application Requirements
Data Type	Unsigned16
Object Class	-
Access	rw
PDO Mapping	No
Value Range	0..1
Default Value	

Value	Application Requirements
0	Minimum tracking error
1	Minimum overshoot

Auto-tuning Procedure

Index	0x3426
Name	Start Auto-tuning procedure
Object Code	
Data Type	Unsigned32
Object Class	all
Access	rw
PDO Mapping	No

Parameters for Autotuning (0x3425) must be previously set.

In order to avoid running the auto-tuning procedure by mistake, the auto-tuning is only executed when a specific signature is written to this sub-index. The signature is 'atun'.
Signature = 0x6E757461

Writing 0 to this object when auto-tuning is running will abort the procedure.

When reading, this object returns the operation status:

Read Value	Meaning
0	Procedure never executed
1	Can not execute
2	Procedure running
3	Procedure aborted by user
4	Procedure stopped on error
>= 5	Procedure done

When running, the BUSY bit of status word (0x6041) is set.

Remark:

The parameters calculated by the auto-tuning depend on which mode it is executed (for example, if auto-tuning is executed in Profile Velocity Mode, the position loop gain will be equal to 0).

3.2.2.9 - Save / Load parameters

Internal Load/Save Command

The ServoPac Servo Drive can store parameters in its internal flash memory:

Writing to object 0x1010 initiates the saving procedure which stores the drive parameters in its internal flash memory (inside a file called DRIVEPAR.TXT).

Writing to object 0x1011 initiates the restoring procedure which re-loads the drive parameters from its internal flash memory (from the previously saved DRIVEPAR.TXT file).

Store parameters

Index	0x1010
Name	Store parameters
Object Code	RECORD
Number of Elements	

This command saves the drive parameters in a volatile memory (ram), in a file in an internal flash memory.

Value Description

Sub Index	1
Description	Save all parameter
Data Type	Unsigned32
Access	rw
PDO Mapping	No
Value	writing signature: 0x65766173 save drive parameters

Signature for difference operation:

Operation	Signature	Ascii
Saving of the manufacturer's parameters	0x6E616D73	"sman"
Saving of the calibration saves drive calibration parameters into flash memory.	0x6C616373	"scal"
Saving of the drive parameters saves drive parameters in memory into flash memory (DRIVEPAR.TXT file).	0x65766173	"save"
Saving of the sequence saves sequences from sequence memory into flash memory (SEQUENCE.TXT file).	0x71657373	"sseq"

While operation is running, busy bit in status word (0x6041) is set.

Restore parameters

Index	0x1011
Name	Restore parameters
Object Code	RECORD
Number of Elements	

Value Description

Sub Index	1
Description	Load all parameters
Data Type	Unsigned32
Access	rw
PDO Mapping	No
Value	writing signature: 0x64616F6C load drive parameters

Signature for difference operation:

Operation	Signature	Ascii
Loading of the manufacturer's parameters	0x6E616D6C	"lman"
Loading of the calibration's parameters	0x6C61636C	"lcal"
Loading of the drive parameters (DRIVEPAR.TXT)	0x64616F6C	"load"
Loading of the USER_PAR.TXT file loads parameters from USER_PAR.TXT file into memory.	0x7273756C	"lusr"
Loading of the SEQUENCE.TXT file loads parameters from SEQUENCE.TXT file into sequence memory	0x7165736C	"lseq"
Merging of the SEQUENCE.TXT file merges parameters from SEQUENCE.TXT file into sequence memory	0x7165736D	"mseq"

While operation is running, busy bit in status word (0x6041) is set.

3.2.3 OPERATION MODES

3.2.3.1 - Supported Drive Modes

Supported Drive Modes

A drive can support more than one and several distinct modes of operation. This object gives an overview of the implemented operating modes in the device. This object is read only.

Index	0x6502
Name	Supported drive modes
Object Code	VAR
Data Type	Unsigned32
Object Class	all
Access	ro
PDO Mapping	No
Value	See below

Data Description

Bit Number	Function	Servo Loops
0	Profile Position Mode (pp)	position, speed and current loops
1	Velocity Mode (vm)	speed and current loops
2	Profile Velocity Mode (pv)	speed and current loops
3	Profile Torque Mode (pt)	current loop
4	reserved	
5	Homing Mode (hm)	position, speed and current loops
6	Interpolated Position Mode (ip)	position, speed and current loops
7..15	reserved	
16	Analog Speed Mode (as)	speed and current loops
17	Stepper Emulation Mode (se)	position, speed and current loops
18	Sequence Mode (sq)	position, speed and current loops
19	reserved	
20	Analog Torque Mode (at)	current loop

3.2.3.2 - Mode selection

Index	0x6060
Name	Mode of Operation
Object Code	VAR
Data Type	integer8
Object Class	all
Access	rw
Save	Yes
PDO Mapping	Yes

This parameter changes the operation mode of the drive.

Mode of Operation	Action
1	Profile Position Mode (PP)
3	Profile Velocity Mode (PV)
4	Profile Torque Mode (PT)
6	Homing Mode (HM)
7	Interpolated Position Mode (IP)
-1	Analog Speed Mode (AS)
-2	Stepper Emulation Mode (SE)
-3	Sequence Mode (SQ)
-4	reserved
-5	Analog Torque Mode (AT)

The actual mode is reflected in the operation mode display (object 0x6061).

Index	0x6061
Name	Mode of Operation Display
Object Code	VAR
Data Type	integer8
Object Class	all
Access	ro
PDO Mapping	Yes
Default Value	3

3.2.3.3 - Profile Position Mode

Profile Position Mode

In this mode, a trapezoidal trajectory generator gives the drive the possibility to execute a positioning with preset parameters as target position, profile speed and acceleration.

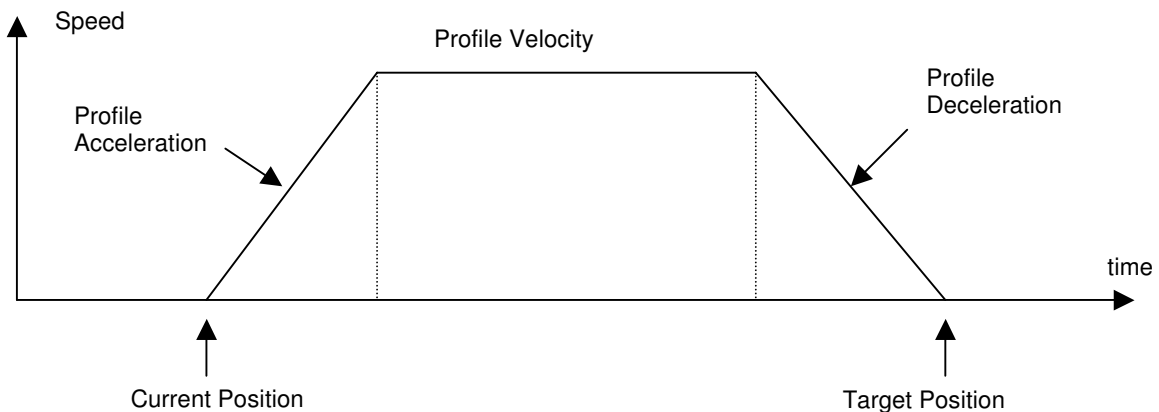

In profile position mode, these bits in the control word are relative to the control of the trajectory:

Bit Number	Profile Position Mode
4	new set point
5	change set immediately
6	0: absolute 1: relative

The movement will be triggered by a rising edge of bit 4 (new_set_point) of the control word. The acknowledgement of the new set point is confirmed by bit 12 (setpoint acknowledgement) of the status word. The target position will be taken as relative to the current position if bit 6 of control word = 1.

The speed profile is trapezoidal (motion profile type = 0) or S-curve (motion profile type = -1).

Change setpoint immediately

Bit change_set_immediately = 1 :

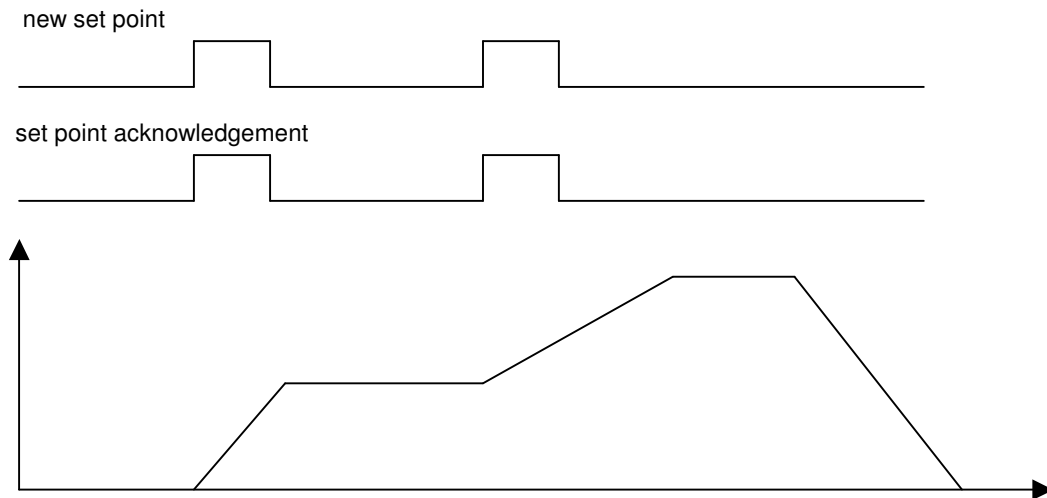

Bit change_set_immediately = 0 :

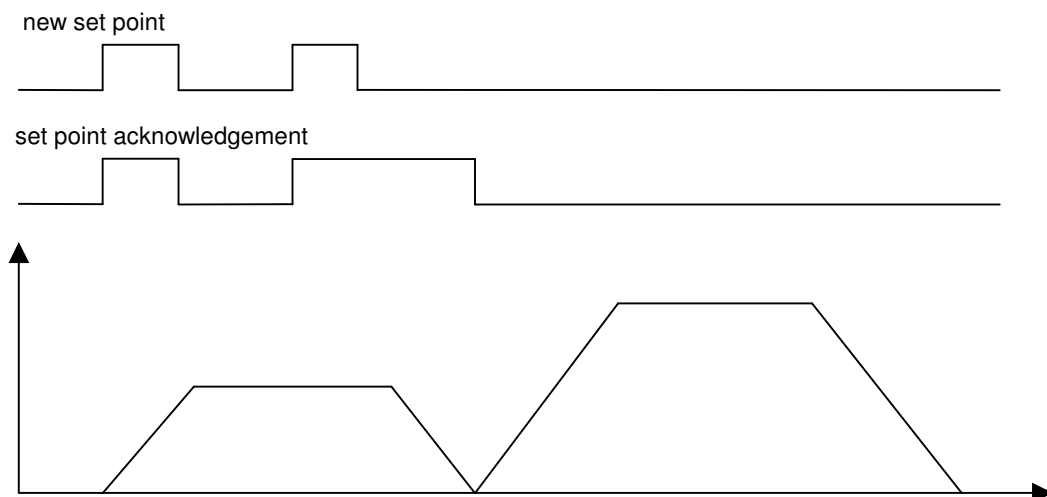

Object Dictionary Entries

Index	Object	Name	Type	Attr.
0x607A	VAR	Target Position	Integer32	rw
0x6080	VAR	Max Motor Speed	Unsigned16	rw
0x6081	VAR	Profile Velocity	Unsigned32	rw
0x6082	VAR	End Velocity	Unsigned32	rw
0x6083	VAR	Profile Acceleration	Unsigned32	rw
0x6084	VAR	Profile Deceleration	Unsigned32	rw
0x6086	VAR	Motion Profile Type	Integer16	rw
0x6067	VAR	Position Window	Unsigned32	rw
0x6068	VAR	Position Window Time	Unsigned16	rw
0x607F	VAR	Max Profile Velocity	Unsigned32	rw
0x3081	VAR	Speed Modulation Source	Unsigned32	rw

Index	0x607A
Name	Target Position
Object Code	VAR
Data Type	Integer32
Object Class	pp
Access	rw
PDO Mapping	Yes
Unit	User Position Unit
Value Range	$(-2^{31})..(2^{31}-1)$
Default Value	0

Target position is the final position where the motor will move to in profile position mode. The start position is the current position. The positioning begins with rising edge of bit 4 of the control word (new set point). Bit 6 of control word indicates if the target position is absolute (=0) or relative (=1) movement.

Index	0x6080
Name	Max Motor Speed
Object Code	VAR
Data Type	Integer32
Object Class	all
Access	rw
PDO Mapping	No
Unit	rpm
Value Range	100...60000
Default Value	3000

The *max motor speed* defines the maximum speed the drive can reach. To avoid a saturation of the servo loop, the running speed must be less than *max motor speed* (depends on the overshoot accepted for the servo loop response).

This parameter modifies the value of the Max Profile Velocity 0x607F.

Index	0x6081
Name	Profile Velocity
Object Code	VAR
Data Type	Unsigned32
Object Class	pp
Access	rw
PDO Mapping	Possible
Unit	User Velocity Unit
Value Range	-
Default Value	0x1000

The *Profile Velocity* is the running velocity for a positioning. If the positioning is too short, the profile velocity may not be reached.

Index	0x6082
Name	End Velocity
Object Code	VAR
Data Type	Unsigned32
Object Class	pp
Access	rw
PDO Mapping	Possible
Unit	User Velocity Unit
Value Range	-
Default Value	0

The *End Velocity* is the final velocity value when the target position is reached. When the motor must stop at the target position, *End Velocity*=0.

Index	0x6083
Name	Profile Acceleration
Object Code	VAR
Data Type	Unsigned32
Object Class	pp
Access	rw
PDO Mapping	No
Unit	User acceleration unit
Value Range	-
Default Value	0x10000

Index	0x6084
Name	Profile Deceleration
Object Code	VAR
Data Type	Unsigned32
Object Class	pp
Access	rw
PDO Mapping	No
Unit	User acceleration unit
Value Range	-
Default Value	0x10000

Index	0x6086
Name	Motion Profile Type
Object Code	VAR
Data Type	Integer16
Object Class	pp, sm
Access	rw
PDO Mapping	No
Value Range	0 -> Trapezoidal profile -1 -> S-Curve
Default Value	0

The S-curve is defined by a polynomial. The acceleration profile is therefore parabolic.

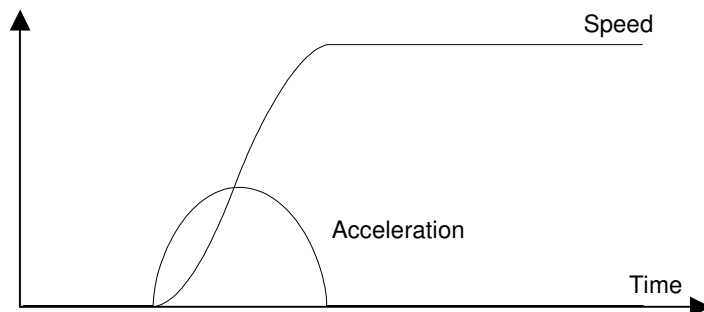

Index	0x6067
Name	Position Window
Object Code	VAR
Data Type	Unsigned32
Object Class	pp
Access	rw
PDO Mapping	No
Unit	User Position Unit
Default Value	0

The *Position Window* defines a symmetrical range of accepted positions relatively to the target position. If the motor current position is within the position window, this target position is considered as reached (bit 10 or status word - Target Reached – is set). If the position window value is 0, the position window control is not active.

When the actual position is within the *Position Window* during the defined *Position Window Time*, the corresponding bit 10 *Target reached* in the *StatusWord* will be set at 1.

Index	0x6068
Name	Position Window Time
Object Code	VAR
Data Type	Unsigned16
Object Class	pp
Access	rw
PDO Mapping	Possible
Unit	Milliseconds
Value Range	0...32767
Default Value	0

Index	0x607F
Name	Max Profile Velocity
Object Code	VAR
Data Type	Unsigned32
Object Class	pv, pp, sm
Access	rw
PDO Mapping	Yes
Unit	User Velocity Unit
Value Range	0...(2 ³² - 1)
Default Value	0

The **Max Profile Velocity** is the maximum allowed speed in any direction during a profiled move.

This parameter limits the input velocity reference in:

- profile position mode (0x6081),
- profile velocity mode (0x60FF),
- profile position function block and profile velocity function block in servo mode.

Position Profile Speed Modulation Input Source

Index	0x3081
Name	Position Profile Speed Modulation Input Source
Description	Index/sub-index of input data
Data Type	Unsigned32
Object Class	sm, pp, sq
Access	rw
PDO Mapping	No
Default Value	0
Value	See below

This object allows to connect any dataflow as a speed modulation of the Profile generator in Profile Position Mode or Profile Generator Function Block in Servo Mode or Sequence Mode.

The structure of the entries is the following:

MSB	LSB
Index (16-bit)	Sub-index (8-bit) 0

The value of the modulation is between 0 and 0x7FFF. A value of 0x7FFF of the modulation means 100 % of programmed velocity.
 If the value of the input source is negative, then the modulation value is the absolute value.

Position Profile Speed Modulation Configuration

Index	0x3082	
Name	Position Profile Speed Modulation Configuration	
Description	This object allows to define the effect of the Position Profile Speed Modulation signal.	
Data Type	Unsigned16	
Object Class	all	
Access	rw	
PDO Mapping	No	
Default Value	0	
Value	bit	description
	0	0 normal effect of the Position Profile Speed Modulation signal: 0 speed is limited to 0 0x7FFF 100% of programmed speed.
	1	reverse effect of the Position Profile Speed Modulation signal 0xFFF speed is limited to 0 0 100% of programmed speed.
	1..15	reserved

Axis Type

Index	0x306A
Name	Axis Type
Object Code	VAR
Data Type	Unsigned8
Object Class	all
Access	rw
PDO Mapping	No
Default Value	0

This parameter define the axis type: linear or rotative.
 A linear axis has the software position limit active.

Value	Function
0	rotative
1	linear

Software Position Range Limit

The Software Position Range Limit defines a Positive Position Limit and a Negative Position Limit which act as hardware limit switches.

The Software Position Range Limit is activated when Axis Type (0x3360) is linear.

Index	0x607F
Name	Software Position Range Limit
Object Code	ARRAY
Object Class	all
Number of Elements	2

Value Description

Sub Index	1
Description	Negative Position Limit
Data Type	Integer32
Access	rw
PDO Mapping	No
Unit	User position unit
Value	

Sub Index	2
Description	Positive Position Limit
Data Type	Integer32
Access	rw
PDO Mapping	No
Unit	User position unit
Value	

3.2.3.4 - Homing Mode

When the feedback sensor does not give the absolute position, the homing mode is the right way to set up the motor to a known position. This position can be detected by using several signals such as positive or negative limit switch, home switch, index pulse or mechanical limit. The choice of the homing method depends on those signals and on the direction of the starting movement.

The drive generates the trajectory according to the homing method. This is the reason why the position loop of the drive is used.

Graphical representation of the trajectories as a function of the input signals:

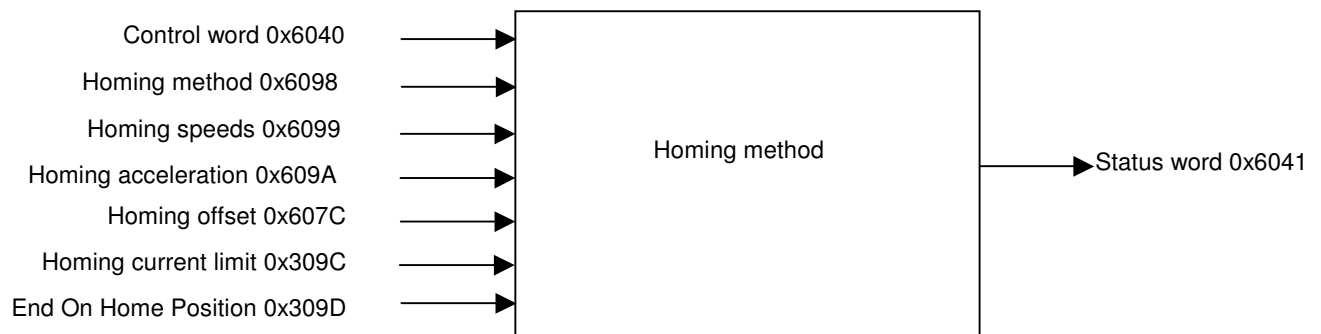

Index	Object	Name	Type	Attr.
0x607C	VAR	Home Offset	Integer32	rw
0x6098	VAR	Homing Method	Integer8	rw
0x6099	ARRAY	Homing Speeds	Unsigned32	rw
0x609A	VAR	Homing Acceleration	Unsigned32	rw

Manufacturer Specific Objects:

Index	Object	Name	Type	Attr.
0x309C	VAR	Homing Current Limit	Unsigned16	rw
0x309D	VAR	End On Home Position	Unsigned16	rw

The homing procedure is launched on rising edge of bit 4 of the Control Word and can be interrupted when clear.

Meanings of operation mode specific bits of the Status Word:

Bit 13	Bit 12	Bit 10	Definition
0	0	0	Homing procedure is in progress
0	0	1	Homing procedure is interrupted or not started
0	1	0	Homing is attained, but target is not reached
0	1	1	Homing procedure is successfully completed
1	0	0	Homing error occurred, velocity is not 0
1	0	1	Homing error occurred, velocity is 0
1	1	X	reserved

If Bit 10 is set, this indicates that the velocity is 0.

If bit 12 is set, this indicates that the home position is known but not available.

Bit 12 is reset at 0:

- at power-up,
- if a sensor fault occurs,
- on homing error,
- when homing is starting,
- when bit 4 of the Control Word is at 0.

Bit 13 indicates a homing error:

- homing launched whereas the drive is not in "operation enable" (except for homing method 35);
- homing launched with an unimplemented selected method.

Bit 13 is reset at zero:

- at drive power-up,
- on rising edge of bit 7 of the Control Word.

Homing Offset

The Home Offset defines the position feedback value when the motor reaches the homing position.

Index	0x607C
Name	Home Offset
Object Code	VAR
Data Type	Integer32
Object Class	hm
Access	rw
PDO Mapping	No
Unit	User position unit
Value Range	$(-2^{31})..(2^{31}-1)$
Default Value	0

Homing Method

The *Homing Method* defines various ways of the drive to search the homing position.

Index	0x6098
Name	Homing Method
Object Code	VAR
Data Type	Integer8
Object Class	hm
Access	rw
PDO Mapping	No
Default Value	23h

Value Description

Method supported: 1..14, 17..30, 33..35.

Methods specific: -1, -2, -3, -4.

Method	Search for Switch	Search for Index Pulse	Remarks
1	Negative Limit Switch	Exterior	
2	Positive Limit Switch	Exterior	
3	Positive Home Switch	Exterior	
4	Positive Home Switch	Interior	
5	Negative Home Switch	Exterior	
6	Negative Home Switch	Interior	
7	Home Switch, Negative Side	Exterior	Positive Initial Move. Reverse direction on Positive Limit Switch.
8	Home Switch, Negative Side	Interior	Positive Initial Move. Reverse direction on Positive Limit Switch.
9	Home Switch, Positive Side	Interior	Positive Initial Move. Reverse direction on Positive Limit Switch.
10	Home Switch, Positive Side	Exterior	Positive Initial Move. Reverse direction on Positive Limit Switch.
11	Home Switch, Positive Side	Exterior	Negative Initial Move. Reverse direction on Negative Limit Switch.
12	Home Switch, Positive Side	Interior	Negative Initial Move. Reverse direction on Negative Limit Switch.
13	Home Switch, Negative Side	Interior	Negative Initial Move. Reverse direction on Negative Limit Switch.
14	Home Switch, Negative Side	Exterior	Negative Initial Move. Reverse direction on Negative Limit Switch.
17	Negative Limit Switch	-	
18	Positive Limit Switch	-	
19	Positive Home Switch	-	
20	Positive Home Switch	-	
21	Negative Home Switch	-	
22	Negative Home Switch	-	
23	Home Switch, Negative Side	-	
24	Home Switch, Negative Side	-	
25	Home Switch, Positive Side	-	
26	Home Switch, Positive Side	-	
27	Home Switch, Positive Side	-	
28	Home Switch, Positive Side	-	
29	Home Switch, Negative Side	-	
30	Home Switch, Negative Side	-	
33		First Index Pulse	Negative Initial Move.
34		First Index Pulse	Positive Initial Move.
35		-	Homing On Current Position
-1	Mechanical Limit, Negative Move	First Index Pulse	
-2	Mechanical Limit, Positive Move	First Index	

		Pulse	
-3	Mechanical Limit, Negative Move	-	
-4	Mechanical Limit, Positive Move	-	

According to the table above, each homing method can be detailed using a diagram representing all of the possible trajectories.

The homing Method 8 is taken as an example :

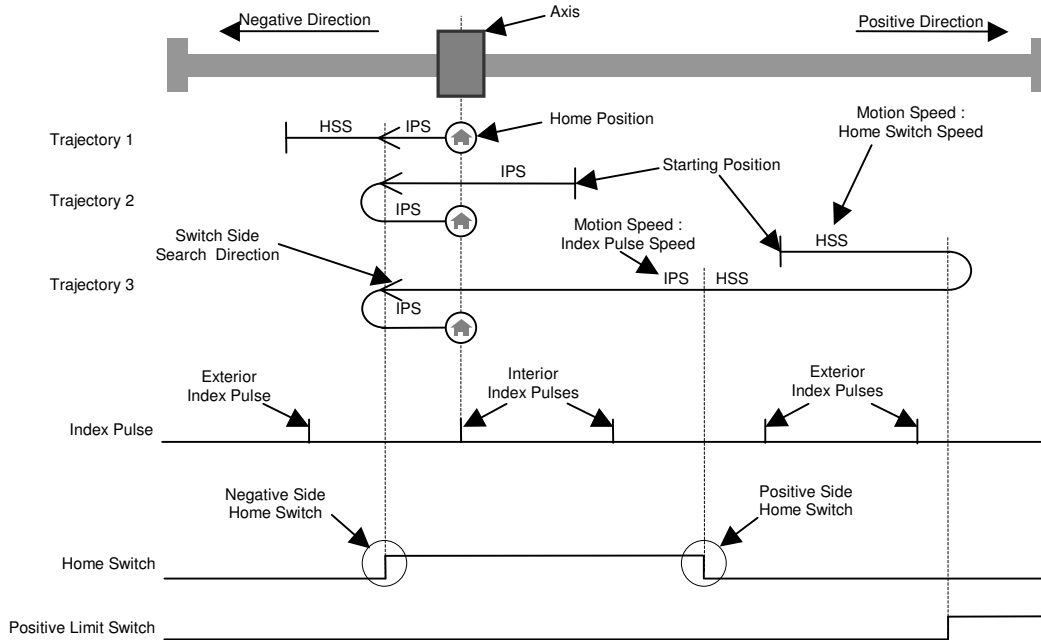

For simplifying diagrams, the trajectory of the switch side search is not explicitly drawn. However, an arrow indicates the direction used to search a switch side. Hence, trajectory 1 of homing method 8 is explained in the following diagram:

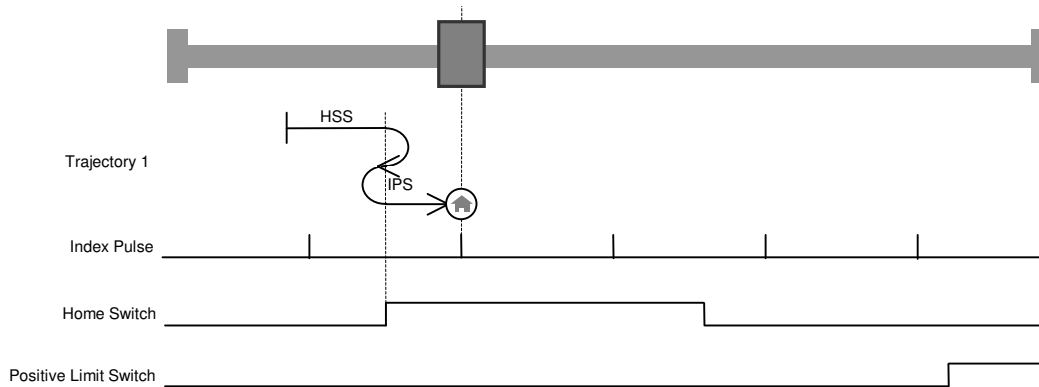

The following explanation describes only trajectory 1 of homing method 8 taken above as an example. Using homing method 8, the initial direction of the movement is positive, except if the home switch is active at the motion start. So, the negative side of the home switch is first searched in the positive direction with the Home Switch Speed. When the activation of the home switch is detected, the drive reverses to look for the home switch deactivation. As the home switch has been found, the speed is the slowest home speed, namely the Index Pulse Speed. Once the deactivation of the home switch has been found, the drive reverses to position to look for the Index Pulse. At this stage, depending on the position sensor, the home position will directly be reached, for example a resolver. For sensors like incremental encoders, a search of Index Pulse position is achieved in the positive direction and then the drive reverses to position on the captured Index Pulse position.

Homing Speeds

Homing Speeds defines the motor speed when searching the homing position.

Index	0x6099
Name	Homing Speeds
Object Code	ARRAY
Number of Elements	2
Data Type	Unsigned32

Value Description

Sub Index	1
Description	Speed during search of switch
Object Class	hm
Access	rw
PDO Mapping	No
Unit	User velocity unit
Default Value	00000019h

Sub Index	2
Description	Speed during search of zero
Object Class	hm
Access	rw
PDO Mapping	No
Unit	User velocity unit
Default Value	0000000Ah

Homing Acceleration

Index	0x609A
Name	Homing Acceleration
Object Code	VAR
Data Type	Unsigned32
Object Class	hm
Access	rw
PDO Mapping	No
Unit	User acceleration unit
Default Value	00010000h

Homing Current Limit

The "Homing current limit" defines the limit of current during the homing on the mechanical limit. The value is defined as a percent of the drive maximum current (defined by object 6510h sub-index 1).

Index	0x309C
Name	Homing Current Limit
Object Code	VAR
Data Type	Unsigned16
Object Class	hm
Access	rw
PDO Mapping	No
Unit	%
Conversion	0 to 0x3FFF -> 0% to 100 %
Default Value	0x0400

Functional Description

The "Homing Current Limit" parameter defines the limit of current in the motor during the homing procedure. When the mechanical limit is reached, the current in the motor increases up to this limit and the motor speed is 0. This position will be taken like the homing position. An offset value (object 607Ch) can be used to preset the homing position value.

Method -1 and -2 define the homing on the mechanical limit with index pulse.

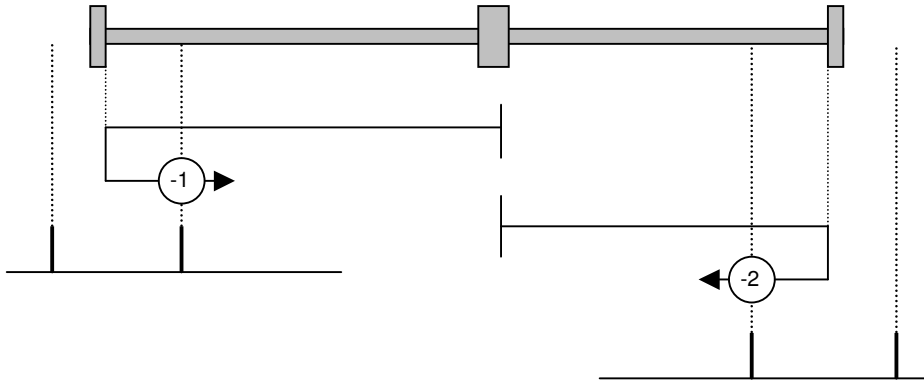

Method -3 and -4 define the homing on the mechanical limit.

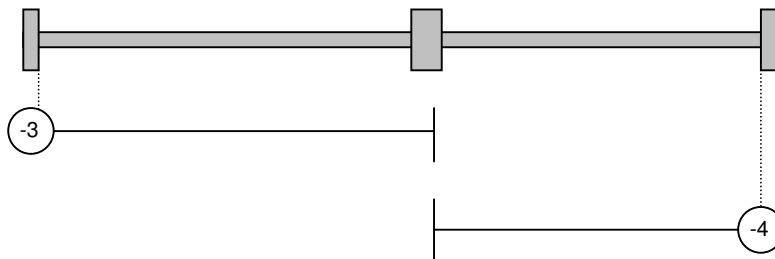

End on Home Position

This parameter allows the drive not to reverse at the end of the homing. If set at 1, it makes a move to the home position when the homing is over. If cleared, the home position is found but not moved to.

Index	0x309D
Name	End on Home Position
Object Code	VAR
Data Type	Unsigned16
Object Class	hm
Access	rw
PDO Mapping	No
Default Value	1

3.2.3.5 - Interpolated Position Mode

Interpolated Position Mode

The interpolated position mode is used to control several axes in coordination. The trajectory must be generated by the host controller and the elementary set point is sent at a fixed cycle time (same as communication cycle time) to all axes.

The cycle time synchronisation of all axes is ensured by the SYNC message. The set point data flow must be sent in real-time.

The elementary set point could be only position if linear interpolation is chosen. The PV interpolation mode requires position and velocity for each set point. The P3 cubic interpolation mode requires only position set point because the interpolator is using the three last position set points. However, the interpolation error is inherent when the acceleration is changing with the P3 cubic interpolation mode.

Both cubic interpolation modes require high position resolution when operating at low speed values. At very low speed, the linear interpolation mode is giving best results.

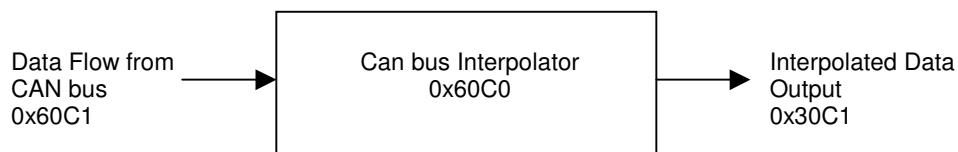

The CAN bus Interpolator is running in any mode but the result of the interpolator (0x30C1) is applied to the position loop only in Interpolated Position Mode.

When using the linear interpolation, the feedforward acceleration term (KA) must be cleared (see interpolation and servo loop). Only a PV interpolation can fully support a feedforward acceleration term.

Index	Object	Name	Type	Attr.
0x60C0	VAR	Interpolation Submode Select	Integer16	rw
0x60C1	RECORD	Interpolation Data Record		rw
0x60C4	RECORD	Interpolation Data Configuration		rw
0x30C1	VAR	Interpolated Data Output	Integer32	rw

Interpolation Submode Select

Index	0x60C0
Name	Interpolation Submode Select
Object Code	VAR
Data Type	Integer16
Object Class	ip
Access	rw
PDO Mapping	No
Value Range	see below
Default Value	0

Interpolation Submode Select	Description
0	Linear interpolation
-1	PV interpolation
-2	P3 interpolation

When in linear interpolation mode, only the first parameter of the interpolation data record is used. The data must be the position reference.

When in PV interpolation mode, the first parameter of the interpolation data record must contain the position reference and the second parameter of the interpolation data record contains the velocity reference.

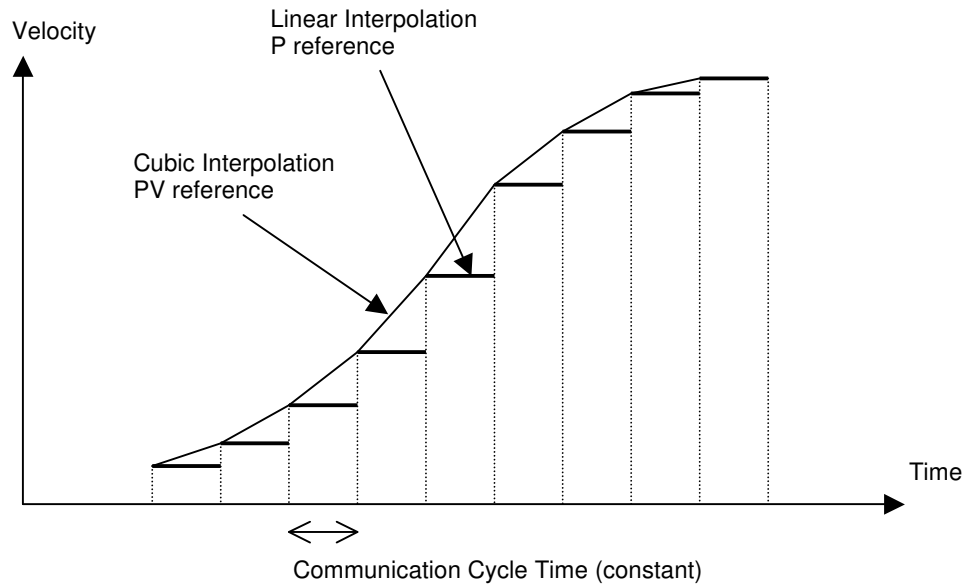

Note: The velocity reference for each set-point must be the instantaneous velocity at this point (not the average velocity).

Interpolation data record

Index	0x60C1
Name	Interpolation data record
Object Code	RECORD
Number of Elements	2

Value Description

Sub Index	1
Description	First parameter of ip function
Data Type	Integer32
Object Class	ip
Access	rw
PDO Mapping	Possible

This sub-index contains the position reference in IP mode.

Sub Index	2
Description	Second parameter of ip function
Data Type	Integer32
Object Class	ip
Access	rw
PDO Mapping	Possible

This sub-index contains the speed reference in IP mode if the interpolation submode select (0x60C0) is -1 (interpolation PV). Otherwise it is not used.

Absolute 16-bit Position Reference for IP mode

Index	0x3350
Name	Absolute 16-bit Position Reference
Object Code	VAR
Data Type	Unsigned8
Object Class	ip
Access	rw
PDO Mapping	No
Value Range	0..1
Default Value	0

The position reference in interpolated position mode can be defined as 16-bits only. This is to reduce the bus traffic.

When in 16-bit mode (object 3350h = 1), the position reference in object 60C1-1 via PDO is set at 16 bits and the drive calculates the upper word. At the beginning, it is necessary to set the upper word with object 60C1-1 via SDO (Integer32). The mapping of RPDO must be changed to object 60C1 sub-index 1 with 16-bit length.

3.2.3.6 - Profile Velocity Mode

Profile Velocity Mode

The profile velocity mode authorizes the drive to operate with a velocity reference. Only speed loop and current loop are closed in this mode.

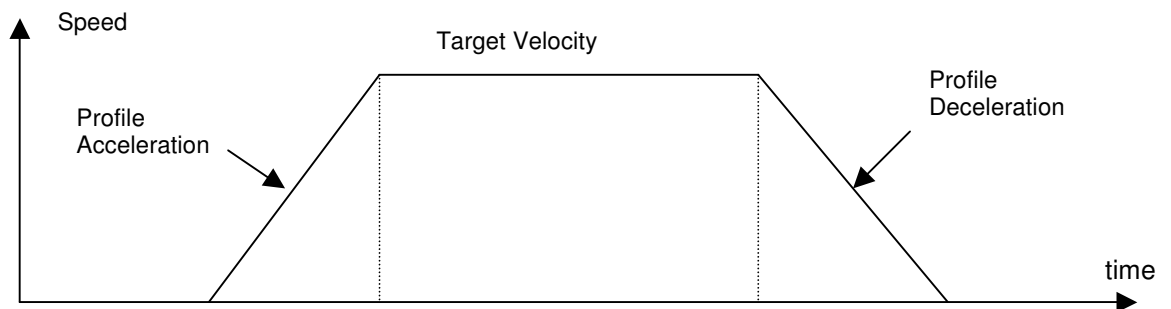

Index	Object	Name	Type	Attr.
0x606B	VAR	Velocity Demand Value	Integer32	ro
0x606C	VAR	Velocity Actual Value	Integer32	ro
0x60FF	VAR	Target Velocity	Integer32	rw
0x6083	VAR	Profile Acceleration	Unsigned32	rw
0x6084	VAR	Profile Deceleration	Unsigned32	rw
0x606D	VAR	Velocity Window	Unsigned16	rw
0x606E	VAR	Velocity Window Time	Unsigned16	rw
0x606F	VAR	Velocity Threshold	Unsigned16	rw
0x6070	VAR	Velocity Threshold Time	Unsigned16	rw
0x30FF	VAR	Target Velocity Source	Unsigned16	rw

Index	0x6083
Name	Profile Acceleration
Object Code	VAR
Data Type	Unsigned32
Object Class	pp
Access	rw
PDO Mapping	No
Unit	User acceleration unit
Value Range	-
Default Value	0x10000

Index	0x6084
Name	Profile Deceleration
Object Code	VAR
Data Type	Unsigned32
Object Class	pp
Access	rw
PDO Mapping	No
Unit	User acceleration unit
Value Range	-
Default Value	0x10000

The **Velocity Window** defines a symmetrical range of accepted velocity relatively to the target velocity. If the motor current velocity is within the velocity window, this target velocity is considered as reached (bit 10 of status word - Target Reached – is set). If the velocity window value is 0, the velocity window control is not active.

Index	0x606D
Name	Velocity Window
Object Code	VAR
Data Type	Unsigned32
Object Class	pv
Access	rw
PDO Mapping	No
Unit	Velocity Unit
Default Value	0

When the actual velocity is within the **Velocity Window** during the defined **Velocity Window Time**, the corresponding bit 10 Target reached in the StatusWord will be set to 1.

Index	0x606E
Name	Velocity Window Time
Object Code	VAR
Data Type	Unsigned16
Object Class	pv
Access	rw
PDO Mapping	Possible
Unit	ms
Value Range	0...32767
Default Value	0

The **Velocity Threshold** defines a symmetrical range of accepted velocity relatively to the 0. If the motor current velocity is within the velocity threshold, this 0 velocity is considered as reached (bit 12 of status word - Velocity = 0 – is set). If the velocity threshold value is 0, the velocity threshold control is not active.

Index	0x606F
Name	Velocity Threshold
Object Code	VAR
Data Type	Unsigned32
Object Class	pv
Access	rw
PDO Mapping	No
Unit	Velocity Unit
Default Value	0

When the actual velocity is within the *Velocity Threshold* during the defined *Velocity Threshold Time*, the corresponding bit 12 *Velocity=0* in the *StatusWord* will be set at 1.

Index	0x6070
Name	Velocity Threshold Time
Object Code	VAR
Data Type	Unsigned16
Object Class	pv
Access	rw
PDO Mapping	Possible
Unit	ms
Value Range	0...32767
Default Value	0

Profile Velocity Mode Input Source

Index	0x30FF
Name	Profile Velocity Mode Input Source for Target Velocity
Description	Index/sub-index of input data
Data Type	Unsigned32
Class	pv
Access	rw
PDO Mapping	No
Value	See below
Default Value	0x60FF0000

This object allows to connect any 32-bit dataflow as target velocity for the Profile Velocity Mode.

The structure of the entries is the following:

MSB	LSB
Index (16-bit)	Sub-index (8-bit) 0

Example:

0x30FF,0 = 0x30F10200

connects the analog input as the target velocity for Profile Velocity Mode.

3.2.3.7 - Profile Torque Mode

Profile Torque Mode

In this mode, the drive operates only with current loops and there is no speed or position control.

Object Dictionary Entries

Index	Object	Name	Type	Attr.
0x6071	VAR	Target Torque	Integer16	rw
0x3071	VAR	Target Torque Input Source	Unsigned32	rw
0x6087	VAR	Torque Slope	Unsigned32	rw
0x6088	VAR	Torque Profile Type	Integer16	rw
0x60B2	VAR	Offset Torque	Integer16	rw
0x6074	VAR	Torque Demand Value	Integer16	ro
0x6077	VAR	Torque Actual Value	Integer16	ro
0x6078	VAR	Current Actual Value	Integer16	ro
0x6079	VAR	DC Voltage	Integer16	ro

The *Target Torque* is the input value for the current loop in profile torque mode. The value is given per thousand of rated current (0x6075).

Index	0x6071
Name	Target Torque
Object Code	VAR
Data Type	Integer16
Object Class	pt
Access	rw
PDO Mapping	Possible
Unit	per thousand of rated current (0x6075)
Value Range	-
Default Value	0

Profile Torque Mode Input Source

Index	0x3071
Name	Profile Torque Mode Input Source for Target Torque
Description	Index/sub-index of input data
Data Type	Unsigned32
Class	pt
Access	rw
PDO Mapping	No
Value	See below
Default Value	0x60710000

This object allows to connect any 16-bit dataflow as a target torque for the Profile Torque Mode.

The structure of the entries is the following:

MSB		LSB	
Index (16-bit)	Sub-index (8-bit)	0	

Example:

0x3071,0 = 0x30F10100

connects analog input 1 as the target torque for Profile Torque Mode.

This parameter defines the torque slope when target torque is changed.

Index	0x6087
Name	Torque Slope
Object Code	VAR
Data Type	Unsigned32
Object Class	pt
Access	rw
PDO Mapping	No
Unit	per thousand of rated current per second
Value Range	-
Default Value	0x10000

The "Current Actual Value" gives the value of the DC current in the drive. This signal is filtered by a low-pass filter (0x3078)

Index	0x6078
Name	Current Actual Value
Object Code	VAR
Data Type	Integer16
Object Class	all
Access	ro
PDO Mapping	Yes
Unit	per thousand of motor rated current (0x6075)
Value Range	-
Default Value	-

The "DC Voltage" gives the value of the DC voltage in the drive. This signal is filtered by a low-pass filter (0x3408-2)

Index	0x6079
Name	DC Voltage
Object Code	VAR
Data Type	Integer32
Object Class	all
Access	ro
PDO Mapping	Yes
Unit	mV
Value Range	-
Default Value	-

3.2.3.8 - Sequence Mode

The purpose of the sequence mode is to allow basic moves.

This basic move is called a sequence and a list of sequences can be pre-programmed and stored in the drive.

Each sequence is identified with a number (sequence number).

The supported sequence types are:

- Positioning sequence
- Homing sequence
- Speed sequence
- Torque sequence

Various sequences can be linked sequentially together to build a complex move.

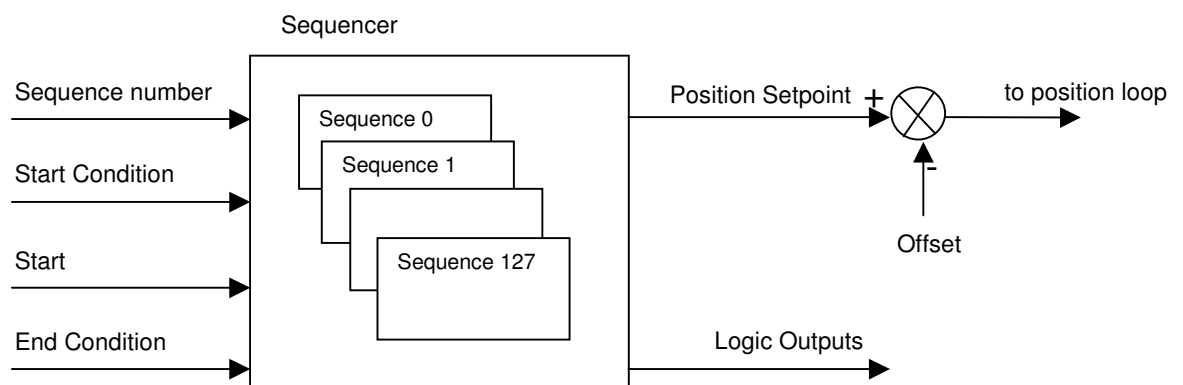

Sequence Number: allows the selection of the sequence to be executed. The "Sequence Number" can be connected to physical logic inputs or set via the fieldbus to select the sequence.

Start Condition: A Logic bits pattern can be defined as a condition for a sequence to be started. The "Start Condition" can be connected to physical logic inputs or to a variable via the fieldbus.

Start: A trigger signal (rising edge of start bit) allows to start the sequence which number is set by a sequence number and if the start condition is fulfilled.

If the start condition is not ok, the movement will not be executed until the start condition is valid.

A sequence is started with bit 4 of control word (0x6040) and stopped with bit 5 of control word.

End Condition: In some sequences, if an "End Condition" is defined, the sequence will be finished when the "End Condition" is valid. The "End Condition" is defined by bits pattern (bits equal to 0, bits equal to 1...), and can be connected to physical logic inputs or to a variable via the fieldbus.

Sequence Chaining

The sequences chaining is controlled by the "SeqNext", "SeqCount", "SeqLink" and "StartCond" parameters.

Sequence Parameters

The parameters of all sequences are stored in a RAM memory (sequence memory).

These sequence parameters can be set:

- by parameter values defined in a sequence file named SEQUENCE.TXT (see Sequence File format).
- by direct access to the sequence parameters via appropriate objects.

Sequence Files

Loading a sequence file:

- all sequence parameters in the sequence memory will be erased by sequences defined in SEQUENCE.TXT
- if a sequence is not defined in SEQUENCE.TXT, then the sequence will be cleared.
- the SEQUENCE.TXT file will be loaded into the sequence memory when the 24V supply is applied
- the SEQUENCE.TXT file will be loaded into the sequence memory when writing into object 0x1011 with the signature = 0x7165736C (lseq)

Merging sequence file:

- only sequences defined in SEQUENCE.TXT will be loaded into the sequence memory; other sequences in the memory are not modified.
- the SEQUENCE.TXT file can be merged in sequence memory when writing into object 0x1011 with the signature = 0x7165736D (mseq).

Objects Definition

Sequence Control

These objects allow to control the execution of a sequence.

Index	Object	Name	Type	Attr.
0x3601	ARRAY	Sequence Inputs		rw
0x3602	ARRAY	Sequence Outputs		rw
0x3603	VAR	Minimum Sequence Pulse	Unsigned16	rw
0x3604	RECORD	Output Pulse Configuration		rw
0x3605	VAR	Sequence phase	Unsigned16	rw
0x360B	VAR	Sequence Capture Position	integer32	rw
0x360C	VAR	Sequence Configuration	Unsigned16	rw
0x360F	VAR	Supported Sequence Type	Unsigned32	rw

Sequence Parameters

These objects allow to access directly any parameter of any sequence.

The selected sequence number is defined by object 0x3610, and all sequence parameters are accessed by object 0x3611.

Index	Object	Name	Type	Attr.
0x3610	VAR	Sequence Parameters Number	integer16	rw
0x3611	RECORD	Sequence Parameters		rw

Positioning Sequence

The main parameters of a positioning sequence are:

- The position to be reached (absolute or relative)
- The motion speed
- The acceleration time
- The deceleration Time
- The delay time at the end of the motion

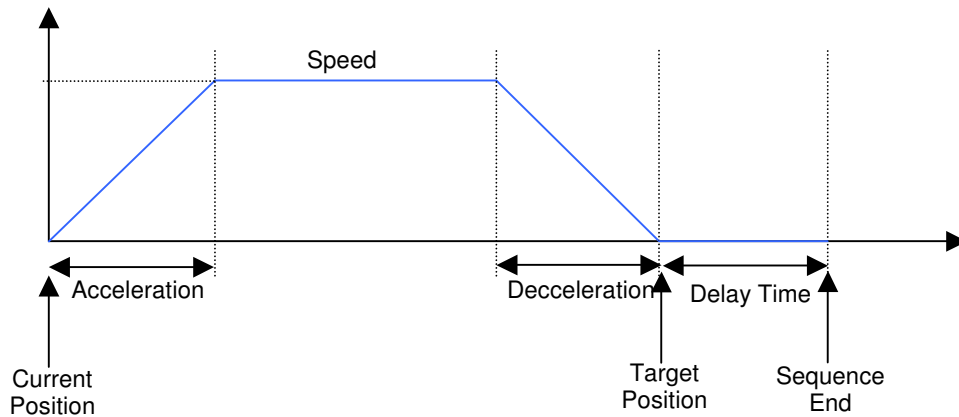

Example of 2 positioning sequences without stopping (the deceleration ramp of the first sequence is 0).

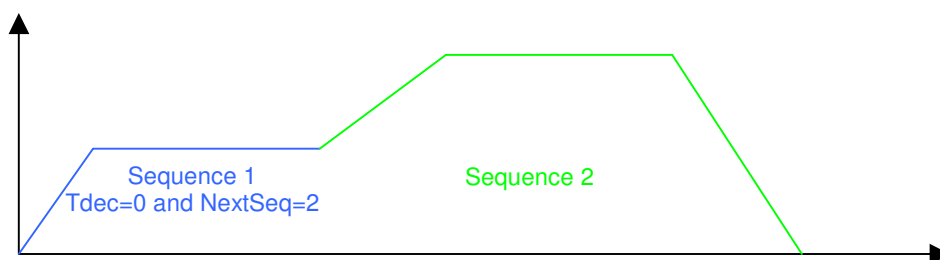

Sequence 1:
 SeqType = POS
 Speed = 150000
 AccelTime = 400
 DecelTime = 0
 NextSeq = 2

Sequence 2:
 SeqType = POS
 Speed = 250000
 AccelTime = 300
 DecelTime = 400

Supported keyword and parameters for a positioning sequence

Keyword	Direct parameter entry	Description
SeqType	0x3611-1	value = POS for SEQUENCE.TXT file or value = 1 for direct parameter object
NextSeq	0x3611-2	see sequence parameters
SeqCount	0x3611-3	see sequence parameters
SeqLink	0x3611-4	see sequence parameters
Trigger	0x3611-5	see sequence parameters
Output	0x3611-6	see sequence parameters
	0x3611-7	
	0x3611-8	
StartCond	0x3611-9	see sequence parameters
	0x3611-10	
Tempo	0x3611-23	see sequence parameters
Speed	0x3611-15	defines the speed setpoint of the sequence in velocity unit
Speed2	0x3611-16	defines the speed setpoint at the end of the sequence in velocity unit
Accel	0x3611-17	defines the acceleration time in user unit per square second
Decel	0x3611-18	defines the deceleration time in user unit per square second
Position	0x3611-13	defines the position setpoint in user unit
EndCond	0x3611-11	see sequence parameters
	0x3611-12	

Home Sequence

The Home sequence allows to perform a homing procedure.

The main parameters of a home sequence are:

- Home Offset
- Home method
- Speeds
- Acceleration
- Current limit (Torque Limit) for method -1, -2, -3 and -4.

The Home sequence runs like in Homing Mode.

Supported keywords and parameters for a home sequence

Keyword	Direct parameter entry	Description
SeqType	0x3611-1	value = HOME for SEQUENCE.TXT file or value = 2 for direct parameter object
NextSeq	0x3611-2	see sequence parameters
SeqCount	0x3611-3	see sequence parameters
SeqLink	0x3611-4	see sequence parameters
Trigger	0x3611-5	see sequence parameters
Output	0x3611-6	see sequence parameters
	0x3611-7	
	0x3611-8	
StartCond	0x3611-9	see sequence parameters
	0x3611-10	
Method	0x3611-22	defines various ways of the drive to search the homing position
Home offset	0x3611-13	defines the position value when the motor reaches the homing position
Speed	0x3611-15	defines the speed during search of switch (velocity unit)
Speed2	0x3611-16	defines the speed during search of zero (velocity unit)
Accel	0x3611-19	defines the acceleration time in acceleration unit
Current Limit	0x3611-25	defines the current limit in per thousand of the rated current for a homing on mechanical limit
EndCond	0x3611-11	see sequence parameters
	0x3611-12	

Speed Sequence

The speed sequence allows to move the axis with a profile speed as follows:

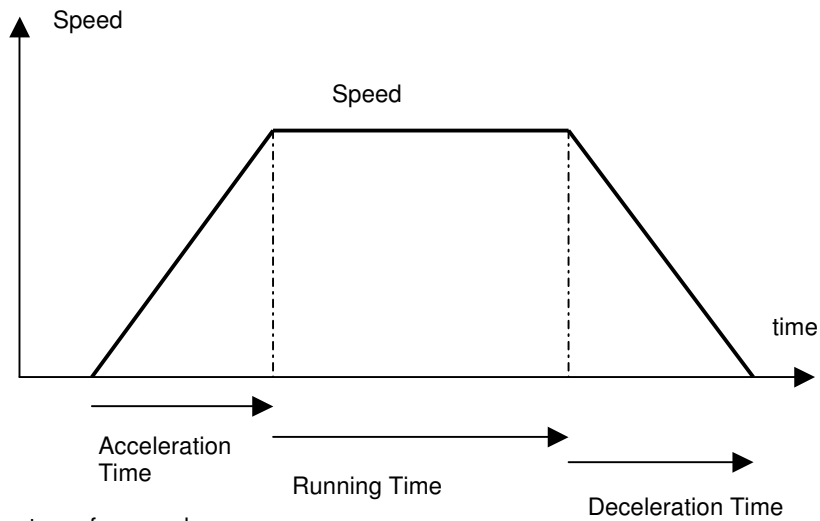

The main parameters of a speed sequence are:

- Speed setpoint
- Acceleration Time
- Deceleration Time
- Running Time

If the Running Time is 65535 (maximum of 16-bit) then the running phase will be executed forever. An "End Condition" can be used to exit this sequence.

If the deceleration Time is 0, then the sequence will end up after the running phase. This allows to combine several sequences for a special profile.

Example of combined sequences:

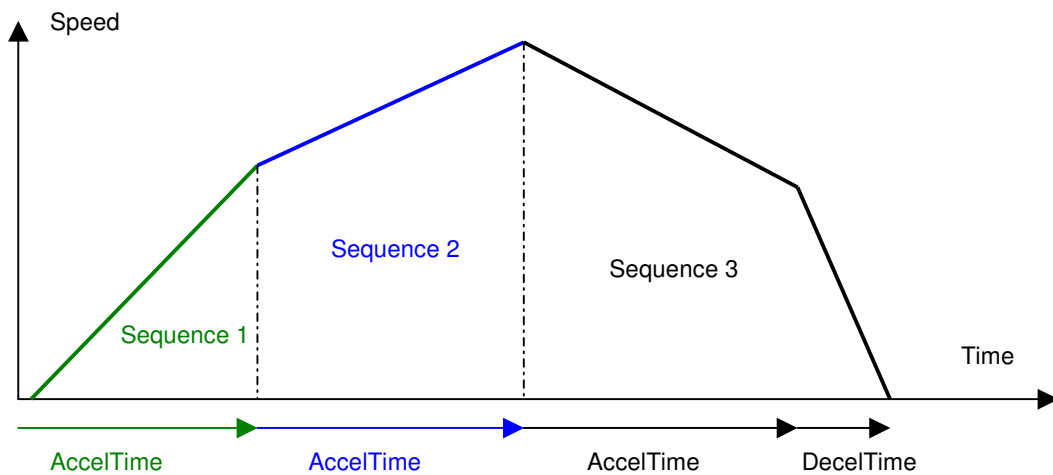

Sequence 1:
 SeqType = SPEED
 Speed = 150000
 AccelTime = 400
 RunTime = 0
 DecelTime = 0
 NextSeq = 2

Sequence 2:
 SeqType = SPEED
 Speed = 250000
 AccelTime = 400
 RunTime = 0
 DecelTime = 0
 NextSeq = 3

Sequence 3:
 SeqType = SPEED
 Speed = 140000
 RunTime = 0
 AccelTime = 400
 DecelTime = 150

The speed setpoint of the Speed Sequence is also limited by the value of the Speed Modulation (0x3081). If the speed modulation is defined, then the sequence speed will be reduced by the speed modulation value.

Supported keyword and parameters for a speed sequence

Keyword	Direct parameter entry	Description
SeqType	0x3611-1	value = SPEED for SEQUENCE.TXT file or value = 3 for direct parameter object
NextSeq	0x3611-2	see sequence parameters
SeqCount	0x3611-3	see sequence parameters
SeqLink	0x3611-4	see sequence parameters
Trigger	0x3611-5	see sequence parameters
Output	0x3611-6	see sequence parameters
	0x3611-7	
	0x3611-8	
StartCond	0x3611-9	see sequence parameters
	0x3611-10	
Tempo	0x3611-23	see sequence parameters
Speed	0x3611-15	defines the speed setpoint the this sequence in velocity unit
AccelTime	0x3611-19	defines the acceleration time in ms.
DecelTime	0x3611-20	defines the deceleration time in ms.
RunTime	0x3611-24	defines the running time in ms.
		A value of 65535 correspond a infinite running time.
EndCond	0x3611-11	see sequence parameters
	0x3611-12	

Torque Sequence

The torque sequence allows to move the axis with a profile speed and a current limit.

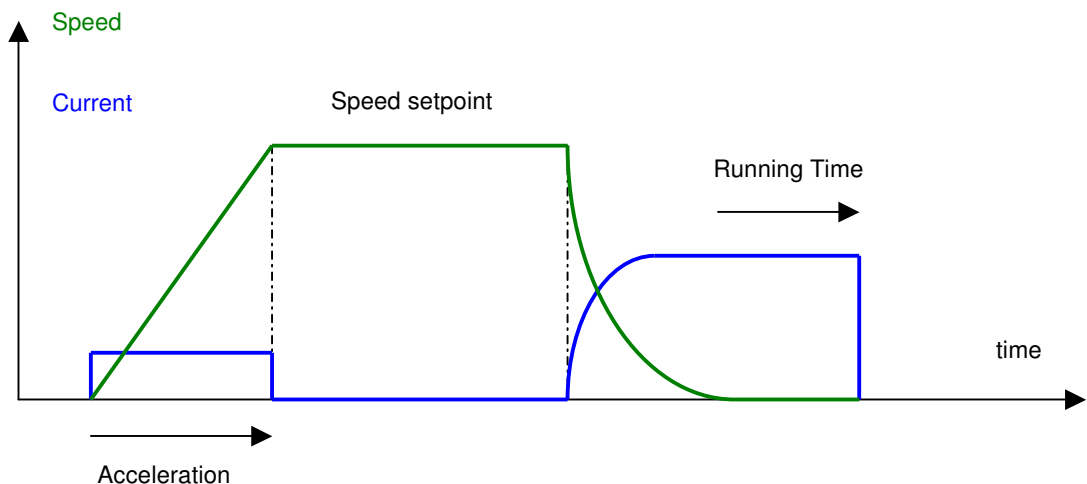

The main parameters of a torque sequence are:

- Speed setpoint
- Acceleration
- Running Time
- Current limit (Torque Limit)

In the torque control sequence, the motor is running at the speed set point value until the current rises up to the limit value. The motor running direction depends on the sign of the speed set point. When the current limitation is reached, the amplifier is holding this current during the time interval defined by the Running Time parameter. If the Running Time = 65535, the torque holding time is infinite. In this case the sequence can be left by an end condition.

At the end of the Running Time, the current position will be captured in object 0x360B.

Notes:

When Torque Sequence is executed, the position following error is disabled.

The Torque Sequence speed is also limited by the value of the Speed Modulation (0x3081). If the speed modulation is defined, then the sequence speed will be reduced by the speed modulation value.

Supported keywords and parameters for a torque sequence

Keyword	Direct parameter entry	Description
SeqType	0x3611-1	Value = TORQUE for SEQUENCE.TXT file or Value = 4 for direct parameter object
NextSeq	0x3611-2	See sequence parameters
SeqCount	0x3611-3	See sequence parameters
SeqLink	0x3611-4	See sequence parameters
Trigger	0x3611-5	See sequence parameters
Output	0x3611-6	See sequence parameters
	0x3611-7	
	0x3611-8	
StartCond	0x3611-9 0x3611-10	See sequence parameters
Speed	0x3611-15	Defines the speed setpoint of this sequence in velocity unit
Accel	0x3611-19	Defines the acceleration time in acceleration unit
RunTime	0x3611-24	Defines the running time in ms. A value of 65535 corresponds a infinite running time.
Torque	0x3611-25	Defines the current limit in per thousand of the rated current
EndCond	0x3611-11 0x3611-12	See sequence parameters

The sequences chaining is controlled by 4 parameters:

- SeqCount,
- SeqNext,
- SeqLink,
- and StartCond.

"SeqCount" defines how many times this sequence will be executed. Then the sequencer will link to SeqNext if the counter is not 0 or link to SeqLink if the counter has expired.
There must be only one SeqCount at a time.

"SeqNext" defines the sequence to be executed after the current one.

When a sequence is started:

If "StartCond" is defined:

- If "start condition" is valid then the sequence will be executed and then link "SeqNext"
- If "Start condition" is not valid then the sequence is not executed but jump to "SeqLink"

If "StartCond" is not defined:

the sequence will be executed and then link "SeqNext".

COUNTER LOOP

The sequences linkage is controlled by the “SeqNext”, “SeqCount” and “SeqLink” parameters.

Application example:

Sequence 1:
 SeqCount = 0
 SeqNext = 2
 SeqLink = -1

Sequence 2:
 SeqCount = 2
 SeqNext = 3
 SeqLink = 1

Sequence 3:
 SeqCount = 0
 SeqNext = -1
 SeqLink = -1

Note: SeqNext = -1 or SeqLink = -1 corresponds to an empty field in the Gem Drive Studio software.

If the execution is starting at sequence 1, the program will be the following:

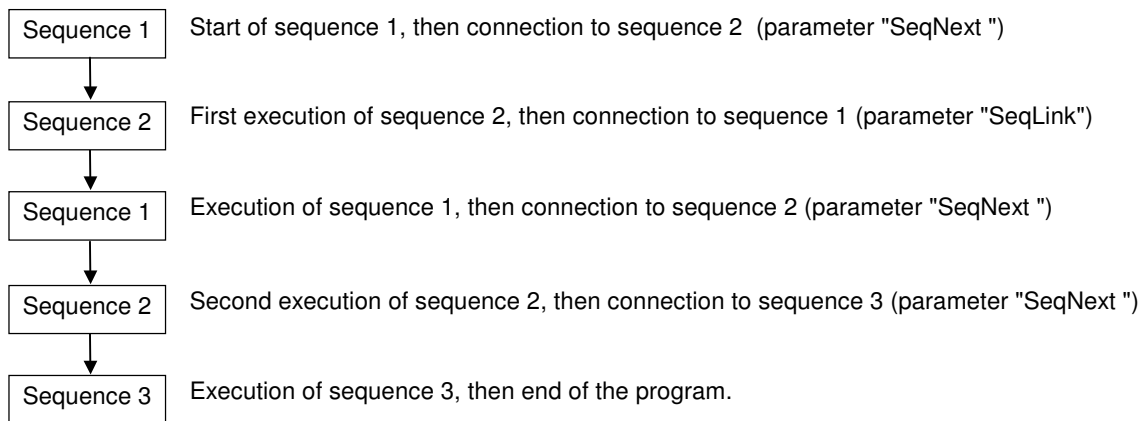

CONDITIONAL JUMP

The conditional jump is controlled by using the “StartCond” and the “SeqNext”, “SeqCount” and “SeqLink” parameters.

Application example:

Sequence 1:
 SeqNext = 2
 SeqCount = 0
 SeqLink = -1

Sequence 2:
 SeqNext = 3
 SeqCount = 0
 SeqLink = 4
 Start Cond = "1....."

Sequence 3:
 SeqNext = -1
 SeqCount = 0
 SeqLink = -1

Sequence 4:
 SeqNext = -1
 SeqCount = 0
 SeqLink = -1

If the execution is starting at sequence 1 and logic input 8 is activated, the program will be the following:

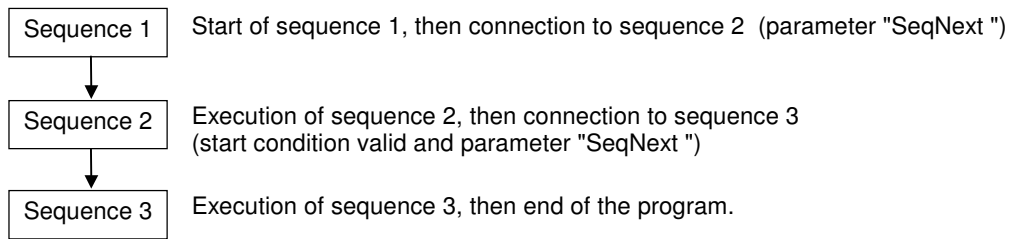

If the execution is starting at sequence 1 and logic input 8 is deactivated, the program will be the following:

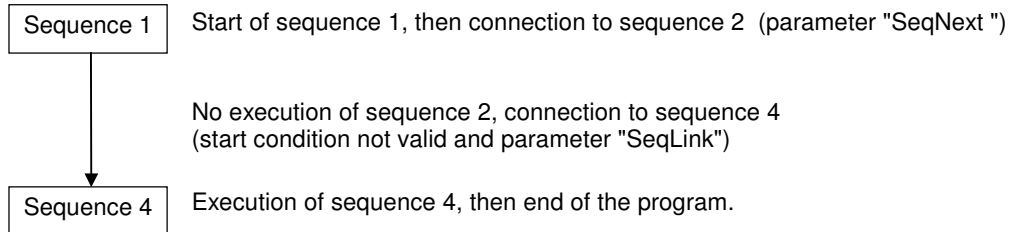

Sequence Inputs

Index	0x3601
Name	Sequence Inputs
Object Code	RECORD
Number of Elements	3

Value Description

Sub Index	1
Description	Sequence Number Input
Data Type	Integer16
Object Class	sq
Access	ro
PDO Mapping	Yes
Default Value	0

This object defines the sequence that will be executed when START is rising up.

Sub Index	2
Description	Executed Sequence Number
Data Type	Integer16
Object Class	sq
Access	rw
PDO Mapping	Yes
Default Value	-

This object indicates the currently running sequence.
A value of -1 means no sequence is running.

Sub Index	3
Description	Conditional Input
Data Type	Integer16
Object Class	sq
Access	rw
PDO Mapping	Yes
Default Value	0

This object defines the bits pattern which is used for start condition or end condition.

Sequence Outputs

Index	0x3602
Name	Sequence Outputs
Object Code	RECORD
Number of Elements	4

Value Description

Sub Index	1
Description	Programmable Logic Outputs
Data Type	Unsigned16
Object Class	sq
Access	rw
PDO Mapping	Yes
Default Value	

Sub Index	2
Description	Programmable Logic Outputs Polarity
Data Type	Unsigned16
Object Class	sq
Access	rw
PDO Mapping	No
Default Value	0

Value	Description
0	For a positive polarity
1	For a negative polarity

Sub Index	3
Description	Dedicated Logic Outputs
Data Type	Unsigned16
Object Class	sq
Access	rw
PDO Mapping	Yes
Default Value	

Bit	Designation	Description
0	POS	This signal is activated when the motor reaches the position and remains enabled until the next motor movement
1	SEQ	This signal indicates that a sequence is currently executed
2	SPEED	This signal indicated that the speed set point is reached during a movement
3	READY	This signal is activated when the drive is OK

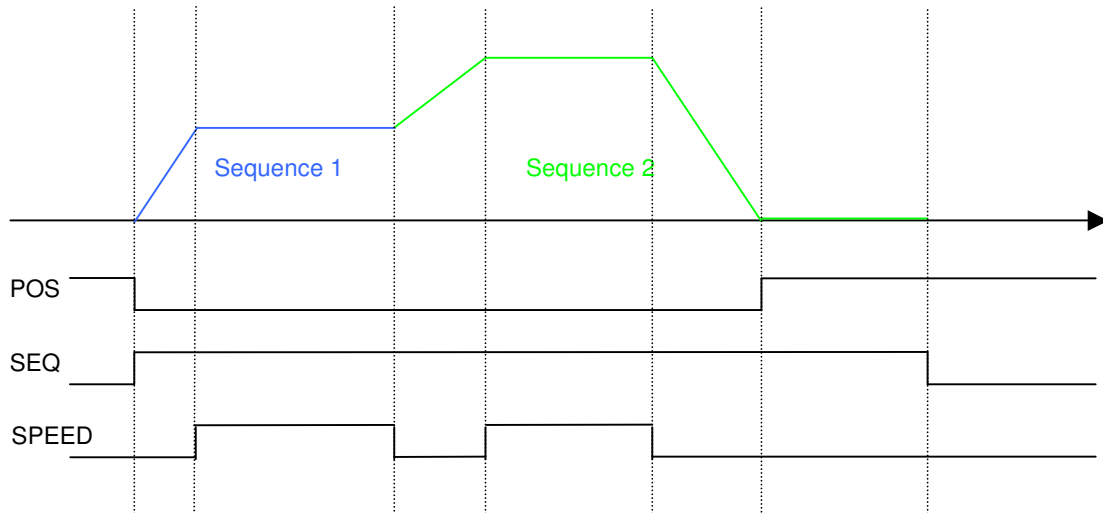

Sub Index	4
Description	Dedicated Logic Outputs Polarity
Data Type	Unsigned16
Object Class	sq
Access	rw
PDO Mapping	No
Default Value	0

Value	Description
0	For a positive polarity
1	For a negative polarity

Minimum Sequence Pulse

This function is useful for the detection of a sequence with a short duration.

Index	0x3603
Name	Minimum Sequence Pulse
Object Code	VAR
Data Type	Unsigned16
Object Class	Sq
Access	rw
PDO Mapping	No
Unit	ms
Value Range	0 this function is not activated 1...65535 this function defines the minimum duration of the SEQ output
Default Value	0

Sequence Outputs

Index	0x3604
Name	Output Pulse Configuration
Object Code	RECORD
Number of Elements	2

Value Description

Sub Index	1
Description	Output Pulse
Data Type	Unsigned16
Object Class	sq
Access	rw
PDO Mapping	No
Value Range	0 the bit number is configured as Output 1 the bit number is configured as Output Pulse
Default Value	0

Sub Index	2
Description	Output Pulse Duration
Data Type	Unsigned16
Object Class	sq
Access	rw
PDO Mapping	No
Unit	ms
Value Range	1...16000
Default Value	0

This parameter defines the duration of the output activation.

Sequence Phase

This object monitors the state inside a sequence.

Index	0x3605
Name	Sequence Phase
Object Code	VAR
Data Type	Unsigned16
Object Class	sq
Access	ro
PDO Mapping	Yes

Data Description

Bit Number	Function
0	begin
1	cruise
2	decel
3	hold
4	inpos
5	end

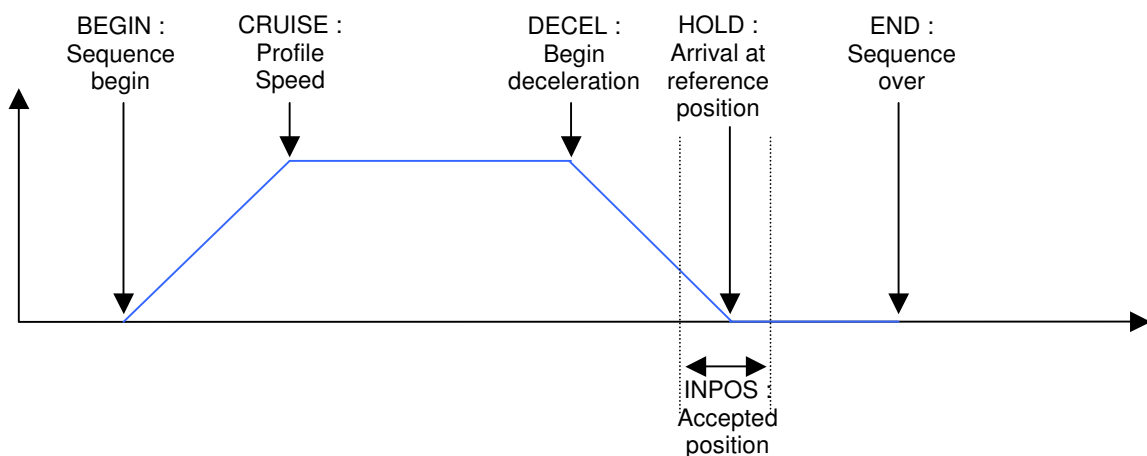

Sequence Captured Position

This object gives the value of the position captured by the torque sequence.

Index	0x360B
Name	Sequence Captured Position
Object Code	VAR
Data Type	Integer32
Object Class	sq
Access	ro
Unit	Position Unit
PDO Mapping	Yes

Supported Sequence Types

Various sequence types can be implemented in a given firmware. This object shows supported sequence types. This object is only read.

Index	0x360F
Name	Supported sequence types
Object Code	VAR
Data Type	Unsigned32
Object Class	sq
Access	ro
PDO Mapping	No
Value	See below

Data Description

Bit Number	Function
0	Positioning sequence
1	Homing sequence
2	Velocity sequence
3	Torque sequence

Sequence File

Description

- Sequence files are text files.
Characters are not case sensitive.
- Parameters syntax is:
Key_word = value
There must be only one key word per line
- Parameter value can be:
 - number: decimal or hexa-decimal (preceded by 0x)
 - constant (text)
- The character ; indicates the begin of a comment to the end of the line.
- A sequence begins with keyword **SeqNb**
- Parameters of a sequence are declared one after the other. Except for **SeqNb**, the parameter order has no importance.
- There is no indication for the end of a sequence. A new sequence with SeqNb indicates the end of the current sequence.

8. Incoherent parameters or values out of the limits will generate an error.
9. In a sequence, parameters which are not declared will have a default value. The default value can be changed by means of the **Default** keyword.
10. The sequencer can load sequence files in two ways:
 - LOAD: load declared sequences from the sequence file into memory. Sequences that are not declared will be cleared.
 - MERGE: load declared sequences from the sequence file into memory. Sequences that are not declared in the file will be kept.

Sequence file example:

```

; define some default values
Default
Accel=100000
Decel=100000

; sequence 1: positioning
SeqNb=1
SeqType=pos
Pos=0x001000
PosType=ABS ; absolute positioning
Speed=100000
Output="..001000"
Trigger=begin ; activate outputs at the beginning of the sequence
Tempo=1000
SeqNext=3

; sequence 3: run at high speed during 10s
SeqNb=3
SeqType=speed
AccelTime=200000
DecelTime=200000
Speed=500000
RunTime=10000
    
```

Sequence Keyword

Supported sequence type:

- Positioning sequence
- Homing sequence
- Speed sequence
- Torque sequence

General Parameters

General parameters are for all sequence types.

Key word	Signification/Constance
SeqType	Sequence Type POS, SPEED, HOME, TORQUE, GEAR
SeqNext	Next sequence
SeqCount	Sequence Counter
SeqLink	Conditional Jump
Output	Output
Trigger	Output trigger BEGIN, CRUISE, DECEL, HOLD, END
StartCond	Start condition inputs
EndCond	End condition inputs

Positioning Sequence

Key word	Signification
PosType	Positioning type: ABS / REL
Pos	Positioning value
Speed	Move Speed

Speed2	End Speed
Accel	Acceleration
Decel	Deceleration
Tempo	Temporization at the end of positioning

Homing Sequence

Key word	Signification
HomeOfs	Position Offset
Speed	Speed during search for switch
Speed2	Speed during search for Zero
Accel	Acceleration
Decel	Deceleration
Method	Homing method
Torque	Torque limit for mechanical limit homing

Speed Sequence

Key word	Signification
Speed	Move Speed
AccelTime	Acceleration Time
DecelTime	Deceleration Time
RunTime	Move Time

Torque Sequence

Key word	Signification
Speed	Move Speed
Accel	Acceleration
Decel	Deceleration
RunTime	Torque limit Time
Torque	Torque limit

3.2.3.9 - Stepper Emulation Mode

Stepper Emulation Mode

The Stepper emulation mode emulates the behaviour of a stepper motor and drive.

The position reference is given by PULSE input and DIR input: when pulse following control is enabled in the control word, the servo motor position setpoint is received via the PULSE and DIR input pins.

The stepper motor emulation application is only possible for motors equipped with a resolver as a position feedback sensor, the encoder input is used for pulse/dir command input (the encoder input must be selected with incremental TTL encoder).

When the amplifier is switched on with the stepper emulation mode selected, Pulse following control is disabled. In this case, the input pulses are not counted and the motor is enabled at standstill. The motor starts following the input pulses when PULSE_ENA (in control word) is set or COUNT_ENA (in 0x3681-3) is set.

The specific bits of the control word (object 0x6040) used in stepper emulation mode are described below:

Bit	Name	Function
4	PULSE_ENA	Enable pulse following
5		reserved
6		reserved

The specific bits of the status word (object 0x6041) used in stepper emulation mode are described below:

Bit	Name	Function
12	PULSE_OK	Pulse following ok
13	PULSE_CNT	Pulse Count

The PULSE_OK is set when drive is enabled and PULSE_ENA or COUNT_ENA is set.
 The PULSE_CNT is active only with PULSE_OK active. The PULSE_CNT signal is described in object 0x3681.

The motor Maximum speed value is calculated according to the host controller pulse frequency limit as follows:
 Maximum speed (rpm) = 60 x pulse frequency limit (Hz) / Stepper resolution. For simple count configuration (object 0x3681-3 bit 7 = 0), the Stepper resolution = User position scaling (object 0x6093-2). For double count configuration (object 0x3681-3 bit 7 = 1), the Stepper resolution = User position scaling (object 0x6093-2) / 2.
 The Max Motor Speed parameter (object 0x6080) is set to the previously calculated maximum speed value + 10% to avoid amplifier speed saturation.

The motor speed depends on the pulse frequency and the parameter User position scaling (object 0x6093-2).

The motor displacement direction with regard to the DIR input logic state can be configured by using the reverse bit of resolver input.

The polarity of the PULSE and DIR inputs is configurable by 0x3681.

Object Dictionary Entries

Index	Object	Name	Type	Attr.
0x3681	VAR	Stepper Emulation Configuration	ARRAY	rw
0x3685	VAR	Pulse following counter	Integer32	ro
0x3686	VAR	Position Set Point	Integer32	ro

Index	0x3681
Name	Stepper Emulation Configuration
Object Code	RECORD
Object Class	se
Number of Elements	4

This object allows to setup the stepper emulation mode parameters.

Value Description

Sub Index	1
Description	Stepper control reserved for futur used
Data Type	Unsigned16
Access	rw
PDO Mapping	Yes

Sub Index	2
Description	Stepper status
Data Type	Unsigned16
Access	ro
PDO Mapping	Yes

Bit	Name	Description
0	PULSE_OK	Pulse following ok
1	PULSE_CNT	Pulse Count

These 2 bits are exactly the same as bits 12 and 13 in status word.

Sub Index	3
Description	Inputs Configuration
Data Type	Unsigned16
Access	rw
PDO Mapping	No
Value	This parameter can only be changed when drive is disabled.

Bit	Name	Description
0-1	SELECT_INP	Inputs Selection: 0 Inputs from Encoder connector (differential line driver inputs) A+/A- -> A or PULSE B+/B- -> B or DIR 1 Inputs from I/O connector (logic opto-coupler inputs) IN5 -> A or PULSE IN3 -> B or DIR 2 Inputs from Hall Effect Sensor (Encoder connector) Hall U -> A or PULSE Hall V -> B or DIR
2		Reserved. Must be 0.
3	CNT_MODE	Inputs Count Mode: 0 Quadrature (A/B) inputs 1 Pulse/Dir inputs
4	PULSE_POL	PULSE or A polarity
5	DIR_POL	DIR or B polarity
6		Reserved. Must be 0.
7	PULSE_DBL	Pulse Count Mode (only for PULSE/DIR input) 0 Simple count. Count on raising edge of PULSE Motor Speed (rpm)=60 * Pulse_Frequency / User position scaling (0x6093-2) 1 Double count. Count on raising edge and falling edge of PULSE Motor Speed (rpm)=120 * Pulse_Frequency / User position scaling (0x6093-2)
8	COUNT_ENA	Count Enable
9-15		Reserved. Must be 0.

Sub Index	4
Description	PULSE_CNT timeout
Data Type	Unsigned16
Access	rw
PDO Mapping	No
Unit	ms
Default value	10

This parameter defines the timeout after the last pulse the signal PULSE_DIR will be reset.

Simple count:

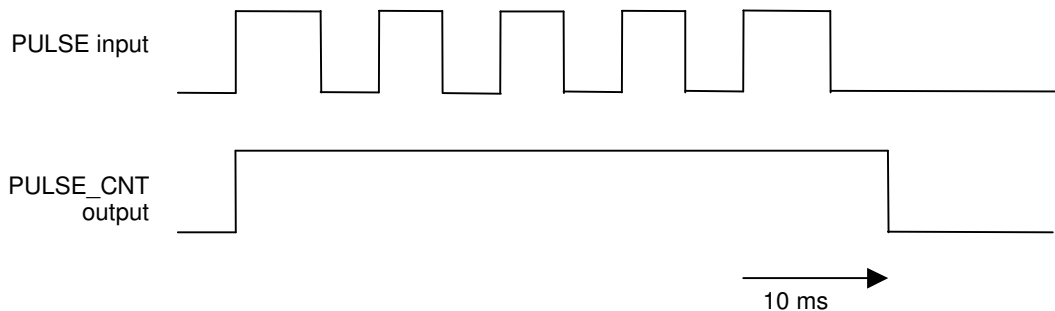

Double count:

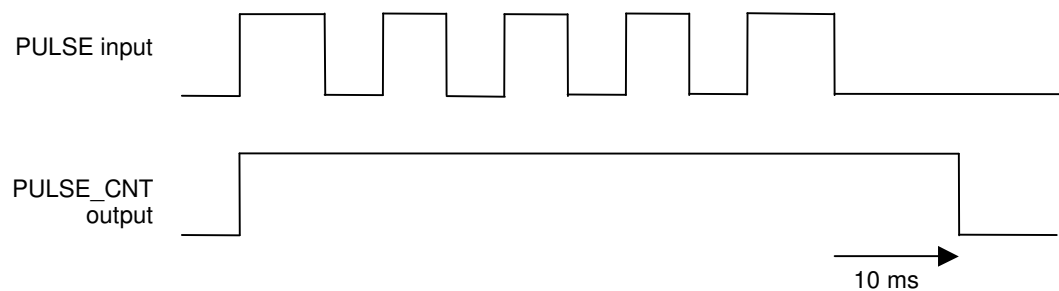

Example Stepper Emulation Configuration

1. Selection of Stepper Emulation Mode

- Mode of operation 0x6060,0 = -2 (this can be done in Gem Drive Studio)

2. Activate PULSE/DIR inputs:

- Enable TTL incremental encoder input
- Disable encoder error control: 0x3025,1 = 0x00240000
- Setup the PULSE/DIR with 0x3681,3 = 0x013A (Inputs from Hall Effect Sensor lines on the encoder connector)
- Set the User position scaling parameter (0x6093-2) according to the desired motor speed
 Motor Speed (rpm)=60 * Pulse_Frequency / User position scaling (0x6093-2) for simple count selection
 Motor Speed (rpm)=120 * Pulse_Frequency / User position scaling (0x6093-2) for double count selection

3. Setup the PULSE_CNT output:

- PULSE_CNT timing: 0x3681,4 = 10
- Connect PULSE_CNT signal to logic output OUT3
 0x3504,3 = 0x36810201 (this can be done in Gem Drive Studio)

4. Autotuning must be executed with "minimum position overshoot".

After autotuning, the term Kav Feedforward acceleration Gain (0x60FB,4) must be reset to 0.

3.2.3.10 - Analog Speed Mode

Analog Speed Mode

In this mode, the ServoPac drive operates as a variable speed drive.

The speed reference is the analog input 1.

The maximum speed defined by 0x6080 is reached with 10V input.

The acceleration time from 0 to maximum speed and the deceleration time from maximum speed to 0 are defined in ms by object 0x604F.

The deceleration time is also defined in ms by object 0x304F. This allows to set a deceleration time different from the acceleration time.

Operation Mode number: -1 (0x6060)

If HALT bit in control word (0x6040) is set, the speed reference is reset to 0.

Index	0x604F
Name	Velocity Ramp
Object Code	VAR
Data Type	Unsigned32
Object Class	as
Access	rw
PDO Mapping	No
Unit	ms
Value Range	0 - 0x3FFF80
Default Value	0

This object define the acceleration time from 0 to maximum motor speed defined in 0x6080, and the deceleration time from maximum motor speed to 0.

Index	0x304F
Name	Velocity Ramp 2
Object Code	VAR
Data Type	Unsigned32
Object Class	as
Access	rw
PDO Mapping	No
Unit	ms
Value Range	0 - 0x3FFF80
Default Value	0

This object define the deceleration time from maximum motor speed to 0.

3.2.3.11 - Analog Torque Mode

Analog Torque Mode

In this mode, the ServoPac drive operates in current loop with current reference from analog input 1.

The 10V in input correspond to maximum current that the drive can

Operation Mode number: -5 (0x6060)

If HALT bit in control word (0x6040) is set, the current reference is reset to 0.

The object 0x3077,0 allows to define a window in which the status bit Target_Reached is set.

Index	0x3077
Name	Torque Threshold
Object Code	VAR
Data Type	Integer16
Object Class	at
Access	rw
PDO Mapping	No
Unit	0x7FFF -> drive amplifier size current
Default Value	0

3.2.4. APPLICATION FEATURE

3.2.4.1 - Digital Input/Output configuration

Digital Inputs / Outputs

The ServoPac drive allows:

- to connect any physical logic input to any bit in any variable,
- to connect any bit in any variable to any physical logic output.

The available logic input functions are:

- Negative Limit Switch
- Positive Limit Switch
- Homing Switch
- Inhibit

Index	Object	Name	Type	Attr.
0x60FD	VAR	Gem Digital Inputs	Unsigned32	ro
0x60FD	VAR	Pac Digital Inputs	Unsigned32	ro
0x3050	ARRAY	Digital Inputs Configuration	Unsigned32	rw
0x3051	VAR	Digital Inputs Polarity	Unsigned32	rw
0x60FE	ARRAY	Gem Digital Outputs	Unsigned32	rw
0x60FE	ARRAY	Pac Digital Outputs	Unsigned32	rw
0x3054	ARRAY	Digital Outputs Configuration	Unsigned32	rw
0x3055	VAR	Digital Outputs Polarity	Unsigned32	rw

Example: realize an ENABLE input with physical input IN1.

- Drive can move only when 24 V supply is applied,
- When 24V is lost, drive must stop.

So, input IN1 must be connected to the "Inhibit" function with 0x3050. When the "Inhibit" function is activated with logic level 1, the input polarity of IN1 must be reversed by object 0x3051.

Digital Inputs

Index	0x60FD
Name	Digital Inputs
Object Code	VAR
Data Type	Unsigned32
Object Class	all
Access	rw
PDO Mapping	Possible
Default Value	No

bit	Function
0	Logic Input Negative Limit Switch Function: 0 running 1 stopped in negative direction
1	Logic Input Positive Limit Switch Function: 0 running 1 stopped in positive direction
2	Logic Input HOME 0 - 1 Home switch activated
3	Logic Input INHIBIT 0 - 1 drive is disabled
12	Logic Input RESET ↑ fault reset
13	Logic Input ENABLE 0 drive is disabled ↑ drive is enabled
14	Logic Input Motor Phasing ↑ start motor phasing
16	Physical input IN1
17	Physical input IN2
18	Physical input IN3
19	Physical input IN4
20	Physical input IN5
21	
22	
23	
24	
25	
26	
27	
28	
29	
30	Encoder Virtual Top Z (defined by 0x3127)
31	Resolver Virtual Top Z (defined by 0x3107)

Digital Inputs Configuration

Index	0x3050
Name	Digital Inputs Configuration
Object Code	ARRAY
Number of Elements	8

The digital Inputs configuration allows to affect any digital input to one bit in a variable indicated by index and sub-index.

Value Description

Sub Index	1-8
Description	Digital Inputs Destination defines the destination object for the corresponding digital input.
Data Type	Unsigned32
Access	rw
PDO Mapping	No
Value Range	
Default Value	

The structure of the entries is the following:

MSB	LSB
Index (16-bit)	Sub-index (8-bit) Bit number n (0-15)

The state of the physical input will be copied into bit n of the object indicated by index and sub-index.

Digital Inputs Polarity

Index	0x3051
Name	Digital Inputs Polarity
Object Code	VAR
Data Type	Unsigned16
Object Class	all
Access	rw
PDO Mapping	Possible
Default Value	No

bit	Function
0	input IN1
1	input IN2
2	input IN3
3	input IN4
4	input IN5
5	
6	
7	
8	
9	
10	
11	
12	
13	
14	
15	

Digital Outputs

Index	0x60FE
Name	Digital Output
Object Code	ARRAY
Number of Elements	2

Value Description

Sub Index	1
Description	Digital Output
Data Type	Unsigned32
Access	rw
PDO Mapping	Possible
Default Value	0

bit	Function
0	Motor Brake
1	
2	
3	
14	
15	
16	OUT1 Physical Output 1
17	OUT2 Physical Output 2
18	OUT3 Physical Output 3
19	
20	
21	
22	
23	
24	
25	
26	
27	
28	
29	
30	
31	

Sub Index	2
Description	Digital Output Bitmask
Data Type	Unsigned32
Access	rw
PDO Mapping	No
Default Value	0

If the Digital Output Bitmask corresponding to "Motor Brake" (bit 0) is set, the sub 1 allows to control the motor brake manually. Otherwise, the motor brake is automatically controlled when the drive is enabled/disabled with a delay.

Digital Outputs Configuration

Index	0x3054
Name	Digital Outputs Configuration
Object Code	ARRAY
Number of Elements	4

The digital outputs configuration allows to affect one bit of any variable indicated by the index and sub-index to a physical output.

Value Description

Sub Index	1-4
Description	Digital Output Source defines the source for digital output.
Data Type	Unsigned32
Access	rw
PDO Mapping	No
Value Range	
Default Value	

The structure of the entries is the following:

MSB	LSB
Index (16-bit)	Sub-index (8-bit) Bit number n (0-31)

The state of bit n of the object index and sub-index will be copied to the physical output.

Digital Outputs Polarity

Index	0x3055
Name	Digital Outputs Polarity
Object Code	VAR
Data Type	Unsigned16
Object Class	all
Access	rw
PDO Mapping	Possible
Default Value	No

bit	Function
0	Physical Output 1
1	Physical Output 2
2	Physical Output 3
3	
4	
5	
6	
7	
8	
9	
10	
11	
12	
13	
14	
15	

3.2.4.2 - Analog Inputs/Output

The ServoPac servo drives have 2 analog inputs.

Index	Object	Name	Type	Attr.
0x30F1	RECORD	Analog Input 1		rw
0x30F2	RECORD	Analog Input 2		rw

Analog Inputs

Index	0x30F1, 0x30F2
Name	Analog Input
Object Code	RECORD
Number of Elements	7

Value Description

Sub Index	1
Description	Analog Input 16-bit Value Conversion data from ADC. The sampling rate is 16 kHz The result is left aligned.
Data Type	Integer16
Access	ro
PDO Mapping	Yes
Value Range	No
Default Value	No

Sub Index	2
Description	Analog Input 32-bit Value
Data Type	Integer32
Access	ro
PDO Mapping	Yes
Value Range	No
Default Value	No

Analog_Input_32bit_Value = (Analog_Input_16bit_Value - Offset) * Gain / 256
The Gain value is signed.

Example: using analog input as speed reference.

The speed reference is 32-bits, so the 32-bit value will be used.

Let's say that the maximum speed is 30000 rpm and the unit is inc/s with 4096 inc per motor revolution.

Maximum speed: 30000 rpm -> 500 rev/s -> 2048000 inc/s

The maximum 16-bit analog input is 32767

Gain = 2048000 / 32767 * 256 = 16000

Sub Index	3
Description	Offset
Data Type	Integer16
Access	rw
PDO Mapping	Yes
Value Range	-
Default Value	0

Sub Index	4
Description	Gain
Data Type	Integer16
Access	rw
PDO Mapping	Yes
Value Range	-
Default Value	256

Sub Index	5
Description	Filter
Data Type	Unsigned16
Access	rw
PDO Mapping	Yes
Unit	Hz
Value Range	5-20000
Default Value	100

The filter is applied on Analog Input 16-bit Value.

Sub Index	6
Description	Analog In Level 0
Data Type	Integer16
Access	rw
PDO Mapping	No
Value Range	
Default Value	

This parameter defines level 0 for position capture with analog input (see diagram below).

Sub Index	7
Description	Analog In Level 1
Data Type	Integer16
Access	rw
PDO Mapping	No
Value Range	
Default Value	

This parameter defines level 1 for position capture with analog input (see diagram below).

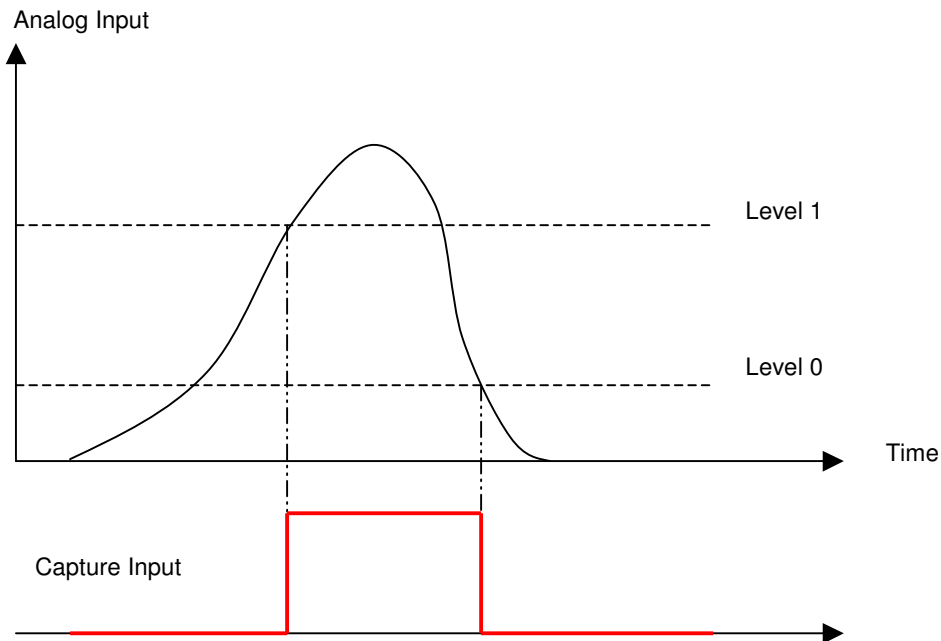

The ServoPac drive has 1 analog output:

- pwm techniques at 48 kHz
- output sampling at 2 kHz
- output signal can be connected to any variable

Object definitions

Index	Object	Name	Type	Attr.
0x30A1	RECORD	Analog Output		rw

Analog Output

Index	0x30A1
Name	Analog Output
Object Code	RECORD
Number of Elements	4

Value Description

Sub Index	1
Description	Analog Output
Data Type	Integer16
Object Class	all
Access	ro
PDO Mapping	Yes

This object monitors the output value.
Output value is from -32768 to 32767 for 0V to 5V on physical analog output.

Sub Index	2
Description	Index/sub-index of Analog Output source
Data Type	Unsigned32
Object Class	all
Access	rw
PDO Mapping	No
Value	See below
Default value	0x30F80100 0x30F80200

This object allows to connect any dataflow as input source of the Analog Output module.

The structure of the entries is the following:

MSB			LSB
Index (16-bit)	Sub-index (8-bit)	0	

The output value is defined by:

$$\text{Analog_Output} = (\text{Source_signal} + \text{Analog_Output_Offset}) * \text{Analog_Output_Gain} / 256$$

Sub Index	3
Description	Analog Output Offset
Data Type	Integer16
Object Class	all
Access	rw
PDO Mapping	No
Default Value	0

Sub Index	4
Description	Analog Output Gain
Data Type	Integer16
Object Class	all
Access	rw
PDO Mapping	No
Default Value	0x0100

3.2.4.3 - Encoder Emulation Output

The ServoPac version "CAN" has an encoder emulation output.

"Incremental Encoder" module features:

- emulates an incremental encoder output with the resolver position or the encoder position.
- sends any value from a different of 2 variables to the incremental output
- output signal as quadrature signals or pulse/dir signals

Two A and B channels in quadrature with one Z marker pulse per revolution allow to close the position loop via the DNC.

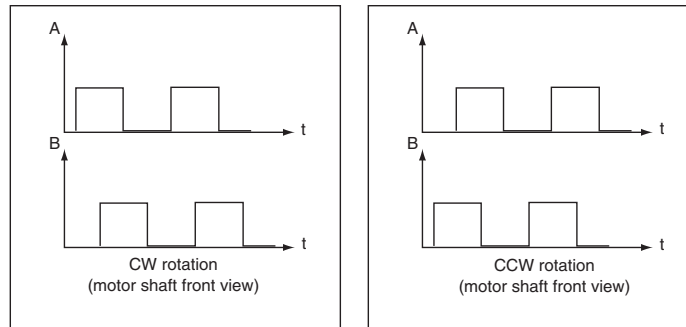

The **Output encoder resolution** parameter is chosen according to following table:

Maximum motor speed (rpm)	up to 1600	up to 3200	up to 6400	up to 12800	up to 25000
Encoder output resolution (ppr)	512 to 16384	512 to 8192	512 to 4096	512 to 2048	512 to 1024

Object definitions

Index	Object	Name	Type	Attr.
0x3160	RECORD	Incremental Encoder Output		rw

Encoder Output

Structure of the Encoder output:

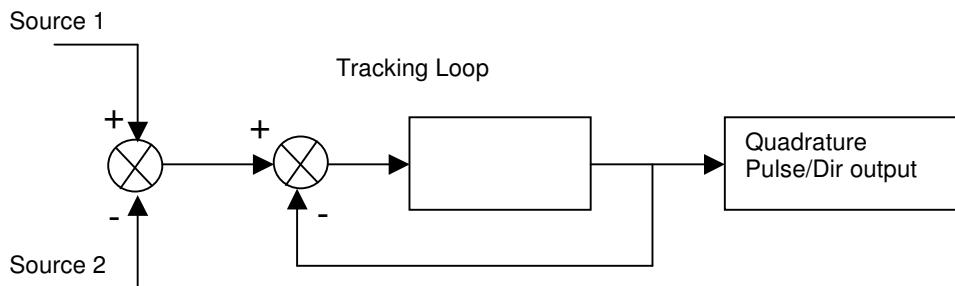

Quadrature output:

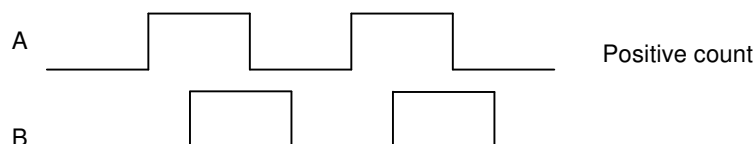

The top Z width is 1/4 of signal period.

Index	0x3160
Name	Encoder Output
Object Code	RECORD
Number of Elements	6

Value Description

Sub Index	1
Description	Index/sub-index of input source 1
Data Type	Unsigned32
Object Class	all
Access	rw
PDO Mapping	No
Value	See below
Default value	0x31000400

This object allows to connect any dataflow as input source of the Encoder Output module.

The structure of the entries is the following:

MSB	LSB
Index (16-bit)	Sub-index (8-bit) 0

Sub Index	2
Description	Index/sub-index of input source 2
Data Type	Unsigned32
Object Class	all
Access	rw
PDO Mapping	No
Value	See above
Default value	0

If value is 0, source 2 is not connected.

Sub Index	3
Description	Encoder Output Resolution
Data Type	Unsigned32
Object Class	all
Access	rw
PDO Mapping	No
Default Value	0x400

Sub Index	4
Description	Encoder Output Deadband
Data Type	Unsigned16
Object Class	all
Access	rw
PDO Mapping	No
Unit	Same as input source signal (Encoder Output Resolution x 4)
Default Value	0

Sub Index	5
Description	Encoder Output Top Z shift
Data Type	Unsigned16
Object Class	all
Access	rw
PDO Mapping	No
Unit	65536 correspond to an encoder revolution
Default Value	0

Sub Index	6
Description	Encoder Output Configuration
Data Type	Unsigned16
Object Class	all
Access	rw
PDO Mapping	No
Default Value	1

Bit Number	Function
0	0 Encoder Output disable
	1 Encoder Output Enable
1	1 Encoder Emulation emulates an encoder output with "Encoder Output Resolution"
	0 direct output the value of (Source1 - Source2) the value of "Encoder Output Resolution" has no effect
3	reserved
6	reserved
7	reserved, must be 0
9	Physical A-line:
	0 A input 1 A output
10	Physical B-line:
	0 B input 1 B output
11	Physical Z-line:
	0 Z input 1 Z output
12	0 Quadrature output
	1 Pulse/Dir output
15	reserved, must be 0

When the "Encoder Emulation" bit is set, a scaling of the input variable (reference by sub index 1) as follows:

input value from 0 to 0xFFFF is scaled to output value of 0 to (resolution x 4)

Only the lower 16-bit of the input value is processed.

If the "Encoder Emulation" bit is cleared, output value = input value.

Example: Encoder Output Emulation with resolver value.

```
0x3160,6 = 0 ; disables encoder output
0x3160,1 = 0x3100400 ; connects encoder output source to the resolver 16-bit value
0x3160,2 = 0
0x3160,3 = 1024 ; resolution : 1024
0x3160,6 = 0x0E03 ; enables encoder output
```

To emulate the encoder output with An Encoder Input, just set 0x3160,1 = 0x31200400.

3.2.4.4 - Digital Cam

Digital Cam

Index	Object	Name	Type	Attr.
0x30E0	ARRAY	Digital Cam positions	Integer32	rw
0x30E1	ARRAY	Digital Cam configuration register	Unsigned16	rw

Cams are fully defined by objects 0x30E0 and 0x30E1. No parameter can be changed if Cam Enable Register is not 0.

Cam Polarity

Each bit of the Cam Polarity Register allows to set the polarity of the cam output. Normal polarity (polarity bit = 0) sets the cam output with value 1 when the cam is active.

Cam Output

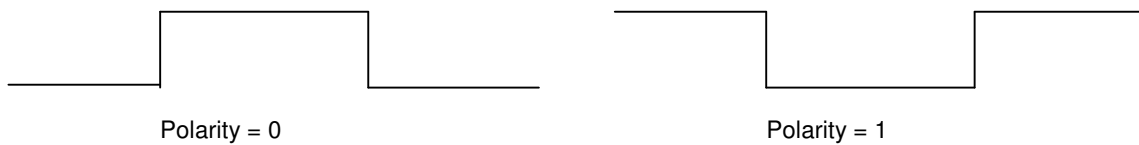

Cam Type

Each bit of the Cam Type Register defines the cam type.

Cam Type = 0: Cam defined by 1 position.

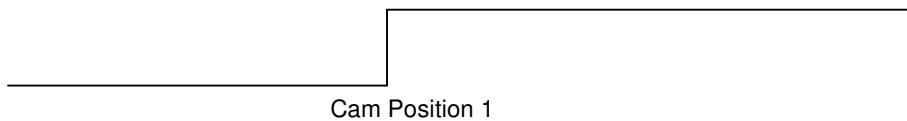

Cam Type = 1: Cam defined by 2 positions.



Cam Hysteresis

Cam Hysteresis Register defines an hysteresis of the cam position.

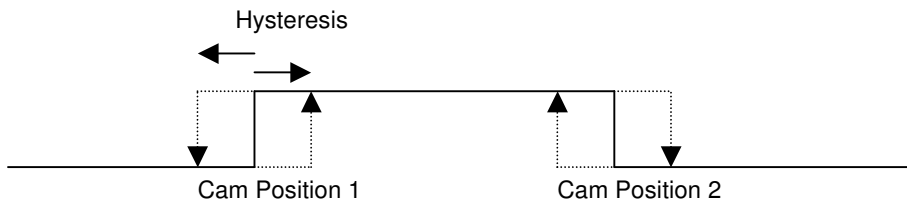

Digital Cam Positions

Index	0x30E0
Name	Digital Cam Positions
Object Code	ARRAY
Number of Elements	32

Digital Cam Positions can only be changed when Cam Enable Register = 0 (0x30E1-5).

Value Description

Sub Index	1
Description	First Position of Cam number 1
Data Type	Integer32
Access	rw
PDO Mapping	Yes
Value Range	No
Default Value	No

Sub Index	2
Description	Second Position of Cam number 1
Data Type	Integer32
Access	rw
PDO Mapping	Yes
Value Range	No
Default Value	No

Digital Cam Configuration Registers

Index	0x30E1
Name	Digital Cam Configuration Registers
Object Code	ARRAY
Number of Elements	32

Registers with sub-indexes 2 to 4 can only be changed when Cam Enable Register = 0.

Value Description

Sub Index	1
Description	Cam Status
Data Type	Unsigned16
Access	ro
PDO Mapping	Yes
Value Range	No
Default Value	No

Each bit of Cam status register corresponds to a Digital Cam (max. 16 cams)

Sub Index	2
Description	Cam Type
Data Type	Unsigned16
Access	rw
PDO Mapping	Yes
Value Range	No
Default Value	0

Each bit of Cam Type register corresponds to a Digital Cam (max. 16 cams)

- 0 Cam with 1 position
- 1 Cam with 2 positions

Sub Index	3
Description	Cam Polarity
Data Type	Unsigned16
Access	rw
PDO Mapping	Yes
Value Range	No
Default Value	0

Each bit of Cam Polarity register corresponds to a Digital Cam (max. 16 cams)

- 0 Cam with normal polarity
- 1 Cam with reversed polarity

Sub Index	4
Description	Cam Hysteresis
Data Type	Unsigned16
Access	rw
PDO Mapping	Yes
Value Range	No
Unit	position unit
Default Value	0

Sub Index	5
Description	Cam Enable
Data Type	Unsigned16
Access	rw
PDO Mapping	Yes
Value Range	No
Default Value	0

Each bit of Cam Polarity register corresponds to a Digital Cam (max. 16 cams)

- 0 Disable Cam
- 1 Enable Cam

3.2.4.5 - Capture

Capture Function

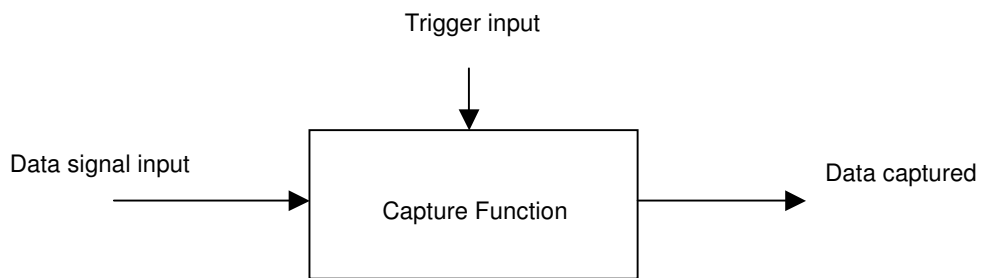

The purpose of the capture function is to latch a data signal (generally position value from a sensor) on a trigger input signal (generally a logic input).

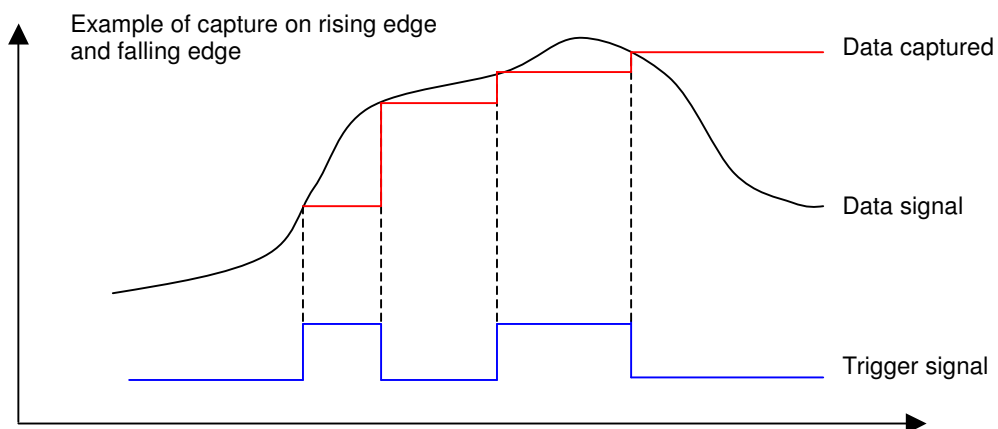

The ServoPac capture features:

- The data signal can be a resolver position value or an encoder position value,
- The trigger input signal can be any of the physical logic inputs, any of the analog inputs or the encoder marker Z,
- The capture can be triggered on rising edge, falling edge or both.
- The trigger input signal can be filtered by a time filter,
- The data signal can be filtered by a space filter.

Capture Time Filter

This parameter defines the time interval threshold of the capture time filter. After the rising or the falling edge of the input signal, the input signal level must be stable for a time interval value greater than or equal to the time interval threshold defined by object 0x3371-4 (0x3372-4) in order to get the position capture validated as described below.

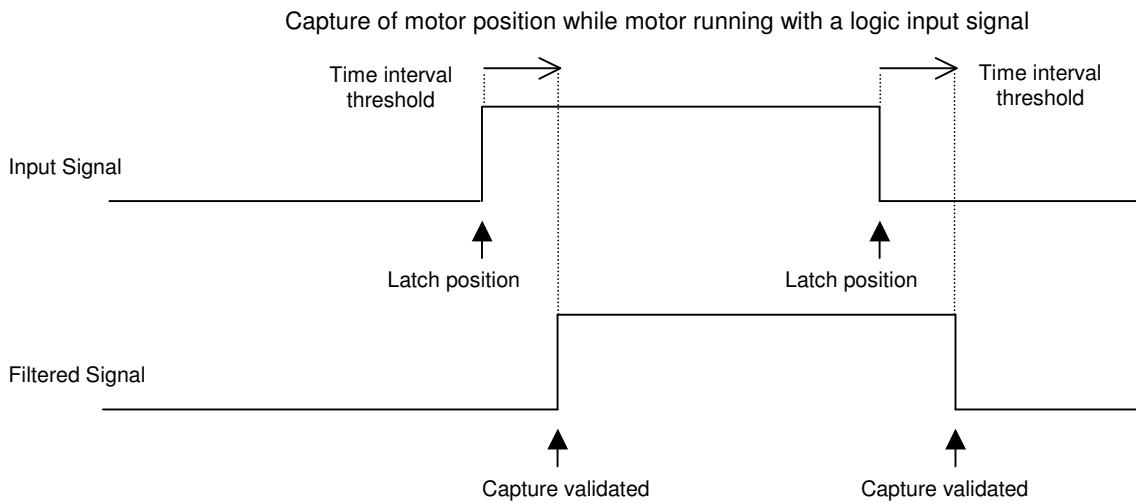

Capture Space Filter

This parameter defines the value in distance threshold of the capture position filter. If the position gap between rising and falling edges is less than the threshold, then the signal is the following:

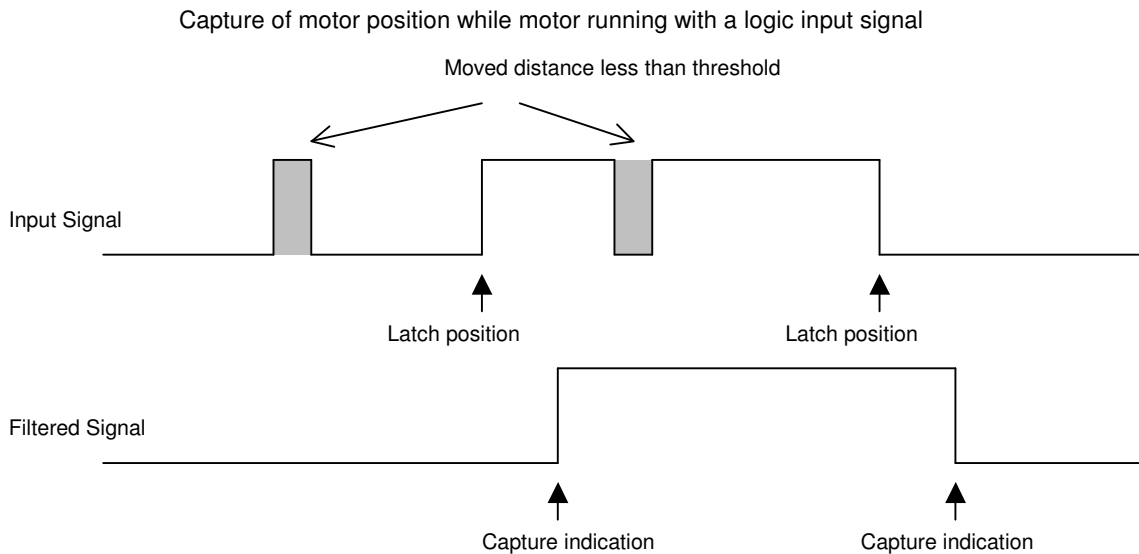

Objects definition

Index	Object	Name	Type	Attr.
0x3370	VAR	Capture Status	Unsigned16	ro
0x337F	VAR	Capture Status for TPDO	Unsigned16	ro
0x3371	RECORD	Capture 1		rw
0x3372	RECORD	Capture 2		rw

Capture Status

Index	0x3370
Description	Capture Status
Data Type	Unsigned16
Access	ro
PDO Mapping	Possible
Value	-
Default value	-

Bit Number	Function
0	
1	Capture Input 1 image
2	change state: a capture on rising edge of input 1 occurred
3	change state: a capture on falling edge of input 1 occurred
4	
5	Capture Input 2 image
6	change state: a capture on rising edge of input 2 occurred
7	change state: a capture on falling edge of input 2 occurred
8	
9	Capture Input 3 image
10	change state: a capture on rising edge of input 3 occurred
11	change state: a capture on falling edge of input 3 occurred
12	
13	Capture Input 4 image
14	change state: a capture on rising edge of input 4 occurred
15	change state: a capture on falling edge of input 4 occurred

The Capture Status is clear when writing to Capture configuration (0x337n-1)

Capture Status for PDO

Index	0x337F
Description	Capture Status for PDO
Data Type	Unsigned16
Access	ro
PDO Mapping	Possible
Value	-
Default value	-

Bit Number	Function
0	
1	Capture Input 1 image
2	A capture on rising edge of input 1 occurred
3	A capture on falling edge of input 1 occurred
4	
5	Capture Input 2 image
6	A capture on rising edge of input 2 occurred
7	A capture on falling edge of input 2 occurred
8	
9	Capture Input 3 image
10	A capture on rising edge of input 2 occurred
11	A capture on falling edge of input 2 occurred
12	
13	Capture Input 4 image
14	A capture on rising edge of input 2 occurred
15	A capture on falling edge of input 2 occurred

Capture indicators (bit 2, 3, 6, 7, 10, 11, 14, 15) are cleared when this object is sent by a PDO.

Capture Parameters

Index	0x3371 for capture 1 0x3372 for capture 2 0x3373 for capture 3 0x3374 for capture 4
Name	Capture Parameters
Object Code	RECORD
Number of Elements	8

Value Description

Sub Index	1
Description	Capture 1/2/3/4 Config
Data Type	Unsigned16
Access	rw
PDO Mapping	No

Bit Number	Function
0	Capture on rising edge
1	Capture on falling edge
15	Enable Capture

Sub Index	2
Description	Capture 1/2/3/4 source
Data Type	Unsigned32
Access	rw
PDO Mapping	No

This parameter allows to connect a 32-bit dataflow as input of the capture data signal.

Only objects 0x3109 (resolver position) and 0x3129 (encoder position) are supported.

The structure of the entries is the following:

MSB	LSB
Index (16-bit)	Sub-index (8-bit) 0

Example:

Capture 1 data is connected to resolver position:
 0x3371,2 = 0x31090000

Sub Index	3
Description	Capture 1/2/3/4 Input
Data Type	Unsigned16
Access	rw
PDO Mapping	No

This parameter allows to define a logic input as capture trigger signal.

Value	Function
0	IN1
1	IN2
2	IN3
3	IN4
4	IN5
5	
6	
7	
8	
9	
10	
11	
12	Analog In 1
13	Analog In 2
14	Encoder Top Z
15	

IN1 .. IN9 are physical inputs.

The capture triggered by the analog input is defined by analog levels (0x30F1).

Sub Index	4
Description	Capture Time Filter
Data Type	Unsigned16
Access	rw
PDO Mapping	No
Unit	

Sub Index	5
Description	Capture Position Filter
Data Type	Unsigned32
Access	rw
PDO Mapping	No
Unit	Position unit

Sub Index	6
Description	Capture Position
Data Type	Integer32
Access	ro
PDO Mapping	Yes
Unit	

Sub Index	7
Description	Rising Edge Capture Position
Data Type	Integer32
Access	ro
PDO Mapping	Yes
Unit	

Sub Index	8
Description	Falling Edge Capture Position
Data Type	Integer32
Access	ro
PDO Mapping	Yes
Unit	

3.2.4.6 - Modulo function

Index	0x307B
Name	Modulo configuration
Object Code	VAR
Data Type	Unsigned16
Object Class	all
Access	rw
PDO Mapping	No
Default Value	0

The motor position can be limited by the position limit function (modulo function).

Minimum Position Limit <= Motor Position < Maximum Position Limit

Bit Number	Function
0	Modulo Function
	0 disable 1 enable
2	Forward (always in positive direction)
3	Backward (always in negative direction)
4	CLEAR input function
	0 disable 1 enable

- "Forward" and "Backward" cannot be set at same time.
- "Modulo Enable/Disable" (bit 0) and CLEAR input function (bit 4) can not be changed when drive is enabled.

Modulo Function with forward:

The forward bit forces the motor to move always in positive direction.

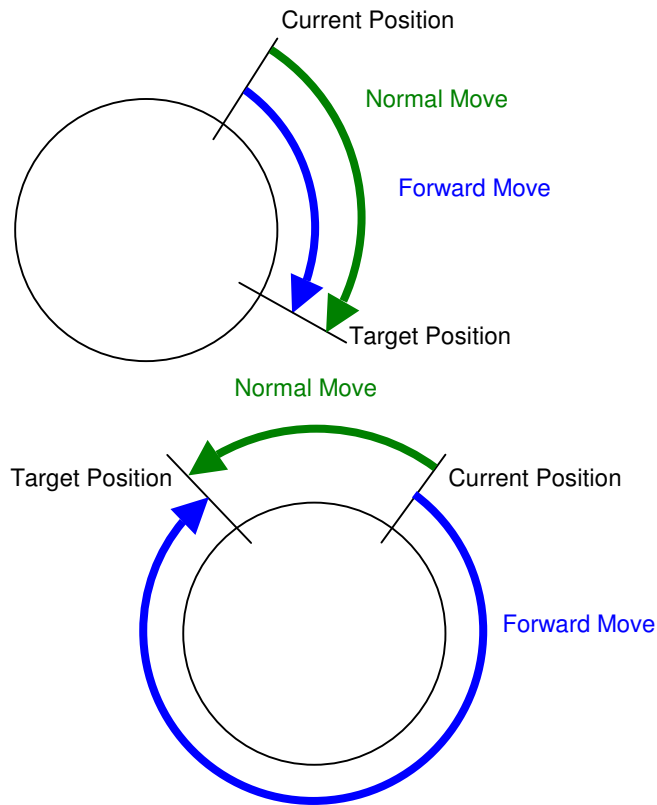

CLEAR input function:

The CLEAR input function allows to use the HOME input (0x60FD) to reset the position value.

CLEAR input function and modulo function must not be activated at the same time.

The motor position can be limited by the position limit function or modulo function.

The modulo function is enabled / disabled by object 0x307B.

Minimum Position Limit <= Motor Position < Maximum Position Limit

The Position Limit values are defined by object 0x607B. These position values can only be changed when the modulo function is disabled.

Index	0x607B
Name	Position Limit
Object Code	ARRAY
Object Class	all
Number of Elements	2

Value Description

Sub Index	1
Description	Minimum Position Limit
Data Type	Integer32
Access	rw
PDO Mapping	No
Unit	User position unit
Value	

Sub Index	2
Description	Maximum Position Limit
Data Type	Integer32
Access	rw
PDO Mapping	No
Unit	User position unit
Value	

3.2.5 - MAINTENANCE

3.2.5.1 - Files

XrapulsPac Files

The ServoPac drive can store data files in its internal Flash memory:

Name	Format	Description
DRIVEPAR.TXT	text object file	Drive parameters are saved in these files. The user can save drive parameters by means of the Gem drive Studio software or via the communication bus by means of object 0x1010 (CAN bus, RS-232...)
USER_PAR.TXT	text object file	This file can keep extra parameters by the user. The parameters are set manually and the USER_PAR.TXT file must be sent to the ServoPac drive.
SEQUENCE.TXT	text sequence file	Sequence files for Positioner Mode

Object File

Object file format

The object file (i.e. CANopen object) is a plain text file allowing to define an object list in the drive, which values must be defined.

The syntax is:

```
index, sub=object_value
```

All digital values can be in hexa (preceded by 0x) or decimal.

Only one allocation per line is allowed.

A comment line begins with a ;

All lines that do not begin with a figure will be ignored.

Example:

```
0x3549, 10=0x12
```

means the allocation of value 0x12 to object index 0x3549 sub-index 10

```
13641, 0xA=18
```

gives the same result.

Notes

- The drive parameter file (DRIVEPAR.TXT) has also got this format.
- The USER_PAR.TXT file is not mandatory. It allows, for example, to define an initial configuration of the drive directly by the user.

3.2.5.2 - Firmware update

Update File

An Update File contains a file header and one or several data blocks.

- File_Header
- Binary_Block_1
- Binary_Block_2
- ...
- Binary_Block_n

File_Header (32 bytes):

```
00000000 File_code 'IDUF' (0x46554449)
00000004 File_crc32: from byte 4 to the end of file
00000008 Protect Data length (bytes): file_length - 8
0000000C Device Sectors
00000010 Update_Code
00000012 Number of Binary Blocks
00000014 Number of Block Type
00000016 Version
00000018 Device Address
0000001C reserved
00000020 First Binary Block
```

Binary_Block_k: Block_Header + Block_Data

Block header (16 bytes):

```
00000000 Block_crc32: from byte 4 to the end of block
00000004 Block_type: 1-algo, 2-security, 3-code
00000006 Block_Cmd
00000008 Block_addr: Device memory address
0000000C Block_length: length of block data (bytes)
00000010 Block data...
```

Update Interface

General Commands

Index	0x5F30
Name	Update
Object Code	RECORD
Number of Elements	5

Value Description

Sub Index	1
Description	Update_Code
Data Type	Unsigned16
Access	rw
Value	Write: Select firmware_Code (> 0) Read back: same code = Update_Code supported, 0 if not supported

Sub Index	2
Description	Update_Mode
Data Type	Unsigned16
Access	rw
Value	Write signature: 0x00000001 Change to update mode, Update_Code must be <> 0 depend on Update_Code, the execution time of this instruction may be very long: for example: update firmware -> switch from firmware mode to bootmanager mode

Update Init

Index	0x5F31
Name	Update Init
Object Code	RECORD
Number of Elements	5

Sub Index	1
Description	Number of Binary Blocks
Data Type	Unsigned16
Access	rw
Value	

Sub Index	2
Description	Number of Block Types
Data Type	Unsigned16
Access	rw
Value	

Sub Index	3
Description	Sectors
Data Type	Unsigned32
Access	rw
Value	Each bit = 1 sectors support up to 32 sectors

Sub Index	4
Description	Erase Command
Data Type	Unsigned32
Access	rw
Value	Signature = 0x00000001 the execution time of this instruction is very long

Block process

Index	0x5F32
Name	Block process
Object Code	RECORD
Number of Elements	5

Value Description

Sub Index	1
Description	Block_Type
Data Type	Unsigned16
Access	rw
Value	defines the Block_Type of data bock

Sub Index	2
Description	buffer_Size (read-only)
Data Type	Unsigned32
Access	ro
Value	gives the buffer size (bytes) for current block (depends on block_type)

Sub Index	3
Description	Current_sector (read-only)
Data Type	Unsigned32
Access	ro
Value	

Sub Index	4
Description	Current address (read-only)
Data Type	Unsigned32
Access	ro
Value	

Sub Index	5
Description	Buffer (segmented)
Data Type	Unsigned32
Access	rw
Value	transfer data to/from buffer: binary_block (block_header + block_data)

Programming sequence

Initialization:

Update Code: write 0x5F30,1 = update_code
 Change to program mode: write 0x5F30,2 = 1
 Verify program mode: read 0x5F30,2 = 1

Erase:

Number of Blocks: write 0x5F31,1 = n_blocks
 Number of Block_type: write 0x5F31,2 = n_types
 Sectors Mask: write 0x5F31,3 = sectors_mask
 Erase command: write 0x5F31,4 = 1
 Verify erase command: read 0x5F31,4 = 0

Programming: repeat (n blocks)

Write Block_type: write 0x5F32,1 = block_type
 Write Block (header & data): write seg 0x5F32,5
 Program Block command: write 0x5F32,6 = 1
 Verify program command: read 0x5F32,6 = 0

3.3 - OBJECT LIST

Parameters in bold are saved in the parameter file.

Index	Sub	Name	Description
-------	-----	------	-------------

Communication

0x1005		Sync_ID	Sync CobID
0x1006		Period	Communication Cycle Period
0x100C		Guard_T	NodeGuarding Guard Time
0x100D		LifeTime	NodeGuarding Life time factor
0x1014		Emcy_ID	Emcy CobID
0x1016		HeartBt	Consumer Heartbeat Time
0x1017		HBprod	Producer Heartbeat Time
0x1018		Identity	CANopen Identity object
0x1200		SrvSDO	Server SDO parameter
0x1201		SrvSDO2	Server SDO 2 parameter
0x1280		CliSDO1	Client SDO 1 parameter
0x1281		CliSDO2	Client SDO 2 parameter
0x1400		RPDO1par	RPDO1 parameter
0x1401		RPDO2par	RPDO2 parameter
0x1402		RPDO3par	RPDO3 parameter
0x1403		RPDO4par	RPDO4 parameter
0x1600		RPDO1map	RPDO1 mapping
0x1601		RPDO2map	RPDO2 mapping
0x1602		RPDO3map	RPDO3 mapping
0x1603		RPDO4map	RPDO4 mapping
0x1800		TPDO1par	TPDO1 parameter
0x1801		TPDO2par	TPDO2 parameter
0x1802		TPDO3par	TPDO3 parameter
0x1803		TPDO4par	TPDO4 parameter
0x1A00		TPDO1map	TPDO1 mapping
0x1A01		TPDO2map	TPDO2 mapping
0x1A02		TPDO3map	TPDO3 mapping
0x1A03		TPDO4map	TPDO4 mapping

0x2000		NMTmastr	NMT Start/Stop
0x2001		NMTstate	NMT state
0x2004		AxisName	Axis Name
0x2006		SyncCtrl	Can Synchronisation parameter
	1	SCphase	
	2	SCthresh	
	3	SCadjust	
0x200A		DevAddr	DeviceID
	1	Deviceld	
0x2010		NMTboot	NMT Boot-up
0x205D		NMTcfg	NMT config
0x205E		NMTerror	NMT error behaviour
0x205F		EMCYmsg	

0x2300		SerialP	RS-232 parameters
	1	SP_baud	
	2	SP_data	
	3	SP_par	
	4	SP_stop	
0x2301	0	SP_pro	RS-232 protocol select
0x2310		Can_Baud	Can Baud

General

0x1000		DevType	Device Type
0x1008		DevName	Manufacturer Device Name
0x1009		Hardware	Manufacturer Hardware Version
0x100A		Software	Manufacturer Software Version
0x1010		StorePar	Store parameters
0x1011		LoadPar	Restore parameters
0x6510	0	DrvData	Drive Data
	1	DrvMax	
	2	DrvRated	
	3	DrvVolt	
	4	UserVolt	User Voltage (230 or 400)
	5	LowVolt	Low Voltage Threshold
0x6502	0	DrvModes	Supported drive modes
0x6504	0	ManName	Manufacturer Name

Device Control

0x6040	0	ControlW	Control Word
0x6041	0	StatusW	Status Word
0x605A	0	QStopOC	Quick Stop option code
0x605B	0	ShutDnOC	Shutdown option code
0x605C	0	DisOpOC	Disable Operation option code
0x305A	0	InhOpOC	Inhibit option code
0x6060	0	ModeOp	Mode of Operation
0x6061	0	ModeOpDp	Mode of Operation Display
0x3041		DevState	Device state monitoring
0x3300		StopDec	Stop 1 Ramp
	1	StopDec1	
	2	StopDec2	
0x3301		StopI	Stop 3 current limit
	1	StopI1	
	2	StopI2	
0x3302		StopTime	Stop Time Limit
	1	StopTm1	
	2	StopTm2	
0x6085	0	QS_dec	Quick Stop Ramp
0x3304	0	DrvTime	Amplifier Reaction Time
0x3305	0	BrkTime	Motor Brake Reaction Time

Factor Group

0x608F		PosResol	Encoder Position Resolution
0x6093		Pos1Fact	Position Factor
0x6089	0	Pos1Nota	
0x608A	0	Pos1Dim	
0x3089	0	Pos1Disp	Position Display Factor
0x308A	0	Pos1Unit	Position Unit Name

Motor

0x6410			Motor Data
	1	MotorMan	
	2	MotorNm	
	3	MotorCod	
	4	McatDate	
	5	MmodDate	
	6	Mtype	
	7	Mmaxspd	
	8	Mrtdspd	
	9	Mstalll	
	10	Mpeakl	
	11	M_Kt	
	12	M_J	
	13	Minduct	
	14	Mpolepr	
	15	MPhase	
	16	Moffset	
	17	MTtype	
	18	MTthres1	
	19	MTthres2	
	20	Mpolept	
0x6072		MaxTq	Max Torque
0x6073		Maxl	Motor Max current
0x6075		MotRtdl	Motor Rated Current
0x6076		MotRtdTq	Motor Rated Torque

0x3410		MotorPar	Motor Parameters
	1	PolePair	Current Number of motor pole pairs
	2	MotPhase	Current Motor Phase
	3	RotorOfs	Current Motor Offset
0x340F	0	Induct	Current Motor Inductance
0x3323	0	MT_res	Motor temperature probe monitoring
0x3324		MT_cfg	Motor temperature probe config
	1	MT_probe	Motor temperature type (NTC/PTC)
	2	MT_warn	Motor temperature warning threshold
	3	MT_error	Motor temperature error threshold

Sensors

0x306A	0	Pos_FB	Position Feedback Sensor Select
0x3070	0	Motor_FB	Motor Feedback Sensor Select

Resolver Input

0x3100		Resolver	Resolver monitoring
	1	Res_Sin	
	2	Res_Cos	
	3	Res_Amp2	
	4	Res_Mod	
	5	Res_Amp	
0x3101	0	Res_Setp	Resolver Setup
	1	Res_Type	Enable/Setup Resolver Input
	2	Res_Cfg	
	3	Res_Zsh	
	4	Res_Zsz	
	5	Res_NP	
	6	ResRatio	
0x3102	0	Res_Err	Resolver Error control
	1	Res_Thrs	
	2	Res_Lim	
	3	Res_AmpF	
	4	Res_Rdc	
0x3104		Res_Cal	Resolver Calibration Procedure
0x3105		Res_CalV	Resolver Calibration parameters
0x3107	0	Res_TopZ	Resolver Virtual Top Z
0x3108	0	Res_ofs	Resolver Offset (user position unit)
0x3109	0	Res_pos	Resolver Position (user position unit)
0x310A	0	Res_vel	Resolver Velocity (user velocity unit)

Encoder Input

0x3120		Encoder1	Encoder
	1	Enc1Sin	
	2	Enc1Cos	
	3	Enc1Amp2	
	4	Enc1Mod	
	5	Enc1Amp	
0x3121		Enc1Setp	Encoder Setup
	1	Enc1Type	
	2	Enc1Cfg	
	3	Enc1Zsh	
	4	Enc1Zsz	
	5	Enc1res	
	6	Enc1turn	
	7	Enc1Zlen	
0x3122		Enc1Err	Encoder Error Control
	1	Enc1Cnt	
	2	Enc1Thrs	
	3	Enc1Lim	
0x3124		Enc1CalP	Encoder Calibration
0x3127	0	Enc1TopZ	Encoder Virtual Top Z
0x3128	0	Enc1ofs	Encoder Offset (user position unit)
0x3129	0	Enc1pos	Encoder Position (user position unit)
0x312A	0	Enc1vel	Encoder Velocity (user velocity unit)
0x312B	0	Enc1Ref	
	1	Enc1RefP	
0x312D	0	Enc1Abs	
	1	Enc1Max0	
	2	Enc1Max1	
	3	Enc1Abs0	
	4	Enc1Abs1	
	5	Enc1Ref0	
	6	Enc1Ref1	
0x313E	0	Enc1HesC	

Servo Loops

Current Loop

0x3400		Imon	Motor Current Monitoring
0x3402		Iofs	Motor Current offset measurement
0x3408		Vdcmn	Voltage monitoring
0x30DA		IlimSrc	Dynamic Current Limit Input Source
0x30D1		Ilimit	Current Limitation
0x30D2		IlimCfg	Dynamic Current Limit Configuration
0x30D4		Iq	Current monitor

0x3411	0	CalcIip	Current Loop Calculation
0x3412	0	CalcIlim	Current Limitation Calculation
0x60F6		Tq_CTRL	Current Loop Parameters
	1	IregType	
	2	KPq_I	
	3	KIq_I	
	4	KPd_I	
	5	KId_I	
0x30F5		TqLpmon	Current Loop Monitoring
	1	IdRef	
	2	IqRef	
	3	Idmon	
	4	Iqmon	
	5	VdRef	
	6	VqRef	
	7	PosElec	
0x6079	0	DCvolt	DC Voltage
0x30F5		TqLpmon	Current loop monitoring
0x30F4		IdrvLim	Current limit parameters

0x3413		APstart	Autophasing
--------	--	---------	-------------

0x3414		MCstart	Motor phasing
--------	--	---------	---------------

Speed Loop

0x60F9		Vel_CTRL	Speed Loop Parameters
	1	VregType	
	2	KPv	
	3	KIv	
	4	KIvf	
	5	KCv	
	6	KDv	
	7	KDvf	
	8	KJv	
0x30F9		VFilter	Speed Error Low-pass Filter
	1	SpErrLF1	
	2	SpErrLF2	
	3	SpErrLF3	
0x30F8		VelLpmon	Speed loop monitoring
0x30FA	0	TVelMes	Speed measurement filter
0x30F8		VelLpmon	Speed Loop Monitoring
	1	VelRef	
	2	VelFb	
	3	VelErr	
	4	Idc	
	5	IcomF	

Position Control

0x307B	0	PosRgEna	Modulo configuration
0x607B		PosRange	Position Limit
	1	PosRgMin	
	2	PosRgMax	
0x60FB		Pos_CTRL	Position Control Parameters Set
	1	PregType	
	2	KPp	
	3	KFp	
	4	KAv	
	5	KBv	
0x30FC		PosLpmon	Pos Loop monitoring
	1	PosRef	
	2	PosFB	
	3	Vref	
0x6062		PosDem	Pos Demand Value
0x60B0		PosOfs	Pos Offset
0x6063		IntPos	Position Actual Value
0x6064		ActPos	Actual position
0x6065		PosErWin	Following Error Window
0x3065		FWctrl	Following Error Error control
0x60F4		PosErr	Following Error Actual Value
0x3425	0	Autotune	Autotuning parameters
	1	ATbwidth	
	2	ATtype	
	3	ATselect	
	4	ATappl	
0x3426	0	ATstart	Autotuning
0x3427	0	KsDig	

Error Control

0x3022	0	Error	Error monitoring
	1	Error1	
	2	Error2	
	3	Error3	
0x3023	0	ErrCode	
	1	ErrState	
	2	LastErr	
	3	PrevErr	
0x3024	0	Warning	Warning
0x3025	0	Err_Ctrl	Error control (mask)
	1	ErrMask1	
	2	ErrMask2	
	3	Stop2Mk1	
	4	Stop2Mk2	
	5	Stop3Mk1	
	6	Stop3Mk2	
0x3404	0	lprotect	l ² t monitoring/parameter
	1	l2tMode	
	2	l2t	
	3	lmotor	
	4	lmotorF	

Profile Position Mode

0x607A	0	TargePos	Target Position
0x6080	0	MaxSpeed	Maximum motor speed
0x6081	0	ProfiVel	Profile Velocity
0x6082	0	PPendVel	End Velocity
0x6083	0	ProfiAcc	Profile Acceleration
0x6084	0	ProfiDec	Profile Deceleration
0x6086	0	ProfType	Motion Profile Type
0x6067	0	PosWindo	Position Window
0x6068	0	PosWinTi	Position Window Time
0x607D	0	PosLimit	Software Position Limit
	1	MinPosLm	
	2	MaxPosLm	
0x607F		MaxPPvel	Max Profile Velocity
0x3360	0	AxeType	Axis Type
0x3081	0	SpModSrc	Position Profile Speed Modulation Input Source
0x3082	0	SpModCfg	Position Profile Speed Modulation Configuration

Homing Mode

0x607C		HomeOfs	Home Offset
0x6098		HomeMeth	Homing Method
0x6099		HomeSpds	Homing Speeds
	1	HomeSpd1	Speed during search of switch
	2	HomeSpd2	Speed during search of zero
0x609A		HomeAcc	Homing Acceleration
0x309C		HCurLim	Home Current Limit
0x309D		HEndHome	End On Home Position

Interpolated Position Mode

0x60C0		IPmode	Interpolated SubMode Select
0x60C1		IPrecord	Interpolated Data Record
0x30C1		IPoutput	Interpolation output
0x60C4		IP_conf	Interpolation data configuration

Profile Velocity Mode

0x60B1	0	VelOfs	Offset Velocity
0x30B1	0	VelOfsSc	Offset Velocity input source
0x60FF	0	TargetV	Target Velocity
0x606B	0	VelDem	Velocity Demand Value
0x606C	0	VelAct	Velocity Actual Value
0x306C	0	VelFilt	Velocity measurement filter
0x606D	0	VelWin	Velocity Window
0x606E	0	VelWinTm	Velocity Window Time
0x606F	0	VelThr	Velocity Threshold
0x6070	0	VelThrTm	Velocity Threshold Time
0x30FF	0	VellnObj	Target Velocity Input Object

Profile Torque Mode

0x6071	0	TqTarget	Target Torque
0x3071	0	TqSrc	Target Torque input source
0x6087	0	TqSlope	Torque Slope
0x6088	0	TqProfil	Torque profile type
0x60B2	0	TqOffset	Offset Torque
0x30B2	0	TqOfsSrc	Offset Torque input source
0x6074	0	TqDemand	Torque Demand Value
0x6077	0	TqValue	Torque Actual Value
0x6078	0	CurrAct	Current Actual Value
0x3078	0	CurrFilt	Current measurement filter

Sequence Mode

Sequence Control

0x3601		SQin	Sequence Inputs
	1	SQnb	Sequence Number Input
	2	SQrun	Executed Sequence Number
	3	SQcond	Conditional Input
0x3602		SQoutp	Sequence Outputs
	1	SQout	Programmable Logic Outputs
	2	SQoutpol	Programmable Logic Outputs Polarity
	3	SQsta	Dedicated Logic Outputs
	4	SQstapol	Dedicated Logic Outputs Polarity
0x3603	0	SQSpulse	Minimum Sequence Pulse
0x3604		SQoutcfg	Output Pulse Configuration
	1	SQOpulse	Output Pulse
	2	SQOtime	Output Pulse Duration
0x3605	0		Sequence phase
0x3606	0		Sequence Position Setpoint value
0x3609	0		Sequence Position Offset
0x360A	0		Sequence Position Output
0x360B	0		Sequence position capture
0x360C	0	SQconfig	Sequence Configuration
0x360F	0	SQavail	Supported Sequence Type

Sequence Parameters

0x3610	0	SQParNb	Sequence Parameters Number
0x3611	0	SQPar	Sequence Parameters
	1	SQPtype	Sequence Type
	2	SQPnext	Next sequence
	3	SQPcnt	Sequence Counter
	4	SQPlink	Sequence Link
	5	SQPtrig	Output Trigger
	6	SQPout0	Output Bits = 0
	7	SQPout1	Output Bits = 1
	8	SQPoutT	Output Bits Toggle
	9	SQPst0	Start Condition Bits = 0
	10	SQPst1	Start Condition Bits = 1
	11	SQPstop0	End Condition Bits = 0
	12	SQPstop1	End Condition Bits = 1
	13	SQPpos	Position
	14	SQPpos2	Position 2 (reserved for future use)
	15	SQPvel	Speed
	16	SQPvel2	Speed 2 (reserved for future use)
	17	SQPaccel	Acceleration
	18	SQPdecel	Deceleration
	19	SQPtacc	Acceleration Time

	20	SQPtdec	Deceleration Time
	21	SQPcfg	Configuration
	22	SQPcfg2	Configuration 2
	23	SQPtempo	Temporization
	24	SQPrtime	Running Time
	25	SQPana	Analog In
	26	SQPana2	Analog In 2 (reserved for future use)

Stepper Emulation Mode

0x3681	0	SE_mode	
	1	SEctrl	
	2	SEstatus	
	3	SEconfig	
	4	SEtempo	

Analog Speed Mode

0x604F	0	Vramp	
0x304F	0	Vramp2	

Application FE

Digital Inputs/Outputs

0x60FD	0	Dinput	Digital Inputs
0x3050		DInpCfg	Digital Inputs Configuration
	n	Inp?Cfg	
0x3051	0	InpPol	Digital Inputs Polarity
0x60FE		Doutput	Digital Outputs
	1	Dout	
	2	DoutBMsk	
0x3054		DOutpCfg	Digital Outputs Configuration
	n	Outp?Cfg	
0x3055	0	OutpPol	Digital Outputs Polarity

Analog Inputs

0x30F1		AnalogI1	Analog Input 1
	1	Analn1	
	2	AI1s32	
	3	AI1_ofs	
	4	AI1_gain	
	5	AI1_filt	
	6	AI1_lv0	
	7	AI1_lv1	
	8	AI1_proc	
	9	AI1_db	
0x30F2		AnalogI2	Analog Input 2
	1	Analn2	
	2	AI2s32	
	3	AI2_ofs	
	4	AI2_gain	
	5	AI2_filt	
	6	AI2_lv0	
	7	AI2_lv1	
	8	AI2_proc	
	9	AI2_db	

Analog Output

0x30A1	0	AnalogO1	Analog Output 1
	1	AO1s16	
	2	AO1src	
	3	AO1ofs	
	4	AO1gain	

Encoder Emulation Output

0x3160	0	eOut	Encoder Emulation Output
	1	eOutSrc1	
	2	eOutSrc2	
	3	eOut_res	
	4	eOut_db	
	5	eOut_zsh	
	6	eOut_ctl	
	7	eOut_sta	

Digital Cam

0x30E0		DCamPos	Digital Cam positions
	n	DCam?P?	
0x30E1	0	DCamCFg	
	1	DCamStat	
	2	DCamType	
	3	DCamPol	
	4	DCamHyst	
	5	DCamEna	

Oscilloscope

0x5800	0	Osc_Func	Oscillo function support
0x5804		Osc_Buf	Oscillo Buffer configuration
0x5805	0	OscBufDI	Oscillo Buffer delay
0x5810		OscChCfG	Oscillo Channel config
0x5811		OscChan	Oscillo Channel definitions
0x5812		OscUnit	Oscillo Channel Unit
0x5820		OscTgSrc	Oscillo Trigger configuration
0x5822		OscTrig	Oscillo Trigger 1
0x5828	0	OscTgCtl	Oscillo Trigger Control
0x5829	0	OscTgSta	Oscillo Trigger Status
0x5840		OscTxCfg	Oscillo Buffer transfer configuration
0x5841	0	OscTx	Oscillo Buffer transfer

Firmware Update

0x5F30		UpdtDrv	Update Firmware
0x5F31		UpdtInIt	Update init
0x5F32		UpdtProc	Update process