

# 12V 50W 1 Phase



## Features:

- Full aluminium casing for lightweight and corrosion resistant handling
- Universal AC input
- Overload protection
- Over voltage protection
- Thermal protection
- MTBF: >700,000hrs
- Efficiency > 83%typ.
- Expected life time: 10 years
- 2 year warranty
- RoHS compliant output terminals for fast wiring and easy installation

## PMC-12V050W1AA

### Summary





The new Panel Mount Power Supply is the latest offering from one of the world's largest power supply manufacturers and solution providers - Delta.

The product range offers a nominal output voltage of 12V, a wide temperature range from -10°C to +70°C and a highly dependable minimum holdup time.

The state-of-the-art design is made to withstand harsh industrial environments. What makes the product stand out from the crowd is its lightweight full aluminum body design which can withstand shock and vibration according to IEC60068-2.

Delta's Panel Mount Power Supply also offers overvoltage and overload protection. Using a wide input voltage range design, it is compatible worldwide. The input also includes DC operating voltage from 120-375Vdc. Best of all, this excellent design and quality does not come with a big price tag.

## Technical Data

PMC-12V050W1AA	
<b>Input Data (1)</b>	
Nominal input voltage (wide-range input)	100-240VAC
Input Voltage range	85-264VAC (DC input range 120-375VDC)
Frequency	47-63Hz (0Hz at DC input)
Current consumption (at nominal values)	1.5A max. (1.1A @ 115VAC, 0.7A @ 230VAC)
Inrush current limitation. I <sub>it</sub> (+25 °C) typ.	< 30A @ 115VAC, 65A @ 230VAC
Mains buffering at nominal load (typ.)	> 15ms @ 115VAC , > 80ms @230VAC
Turn-on time after applying the mains voltage	< 2.5Secs @ 100% load
Transient surge voltage protection	VARISTOR
Input fuse, internal (device protection)	T 3.15AH / 250V
Recommended backup fuse: Power circuit-breaker characteristic	6A, 10A or 16A, B.
Discharge current to PE	< 1mA
Connection Method	Screw Connection.
Stripping Length	6 mm or use suitable lug to crimp
<b>Output Data (2)</b>	
Nominal output voltage U <sub>N</sub> / tolerance	12VDC±2%
Setting range of the output voltage	11-14VDC
Nominal output current I <sub>N</sub> with convection cooling:-20 to +50°C	4.17A
Derating above +50°C	2.5% / K.
Current limitation at short-circuits approx.	> 120% of P <sub>O</sub> Max typically.
Startup with capacitive loads	Max 8,000µF
Max. power dissipation idling/nominal load approx.	50W
Efficiency (at 115VAC and nominal values)	> 83% typical.
Residual ripple/ peak switching (20 MHz) (at nominal values)	< 150mVpp
Can be connected in parallel for redundancy and increased capacity	YES with oring Diode.
Surge voltage protection against internal surge voltages	YES
<b>Certification/Standards</b>	
Electrical equipments of machines	IEC60204-1 (over voltage category III)
Electronic equipment for use in electrical power installations	EN 50178 / IEC62103
Safety entry low voltage	PELV (EN 60204), SELV (EN 60950)
Electrical safety (of information technology equipment)	UL/C-UL recognized to UL60950-1, CB scheme to IEC60950-1, TUV
Protection against electric shock	DIN 57100-410
CE	In conformance with EMC directive 2004/108/EC and low voltage directive 2006/95/EC
ITE	EN55022, EN61000-3-2, EN61000-3-3, EN55024
Industrial	EN55011
Limitation of mains harmonic currents	DIN57100-410
	   
<b>RoHS Compliant</b>	<b>Yes</b>

General Data		
Isolation voltage:		
Input / output	type test/routine test	3KVAC
Input / PE	type test/routine test	1.5KVAC
output / PE	type test/routine test	0.5KVAC
Degree of protection		IPX0
Class of protection		Class I with PE connection
MTBF		> 700,000hrs.
Type of housing		Aluminum
Dimensions (L / W / H)		128mmx97mmx38mm
Weight		0.26Kg approx
<b>STATUS Indicator</b>		
LED (6) DC OUTPUT OK		YES (GREEN LED)
<b>Climatic Data</b>		
Ambient temperature (Operating)		-10°C to 70°C (>50°C derating)
Ambient temperature (Storage)		-25°C to 85°C
Humidity	at+25 °C, no condensation	< 95% RH
Vibration (Operating)		10 to 150Hz, @ 50m/S <sup>2</sup> (5G peak); displacement of 0.35mm; 20 min per axis for all X,Y,Z direction. Refer to IEC 6800-2-6. Note: all figures quoted are amplitudes (peak values).
Shock		IEC60068-2-27, 30G (300m/S <sup>2</sup> ) for duration 18ms 1 Shock in 2 Directions tested with Fixture and EUT Panel Mounted in Vertical and Horizontal position
Pollution degree		2
Climatic class		3K3 according to EN 60721
<b>CE</b> In conformance with EMC guideline 89/336/EEC and low voltage directive 73/23/EEC <b>EMC (electromagnetic compatibility)</b>		1AC / 12VDC / 4.17A (EC892447)
Immunity to interference according to EN 61000-6-2		
• EN 61000-4-2 <sup>2)</sup> Discharge of static electricity (ESD)	Housing Contact discharge: Discharge in air:	LEVEL 4 8 KV 15 KV
• EN 61000-4-3 <sup>1)</sup> Electromagnetic HF field	Housing Frequency/Field intensity:	LEVEL 3 80MHz - 14 Hz / 10v/m, with 1kHz tone/80% modulation
• EN 61000-4-4 <sup>2)</sup> Fast transients (Burst):	Input: Output: Signal:	2KV <sup>4)</sup> - -
• EN 61000-4-5 <sup>2)</sup> Surge voltage capacities (Surge):	Input: Output: Signal:	2KV <sup>3)</sup> / 2KV <sup>4)</sup> (Level 3) - -
• EN 61000-4-6 <sup>1)</sup> Conducted disturbance	I/O: Frequency / U <sub>0</sub> :	Level 3 0.15MHz - 80MHz / 10Vrms.
• EN 61000-4-11 <sup>2)</sup> Voltage dips		Input : Main Buffering > 20ms. Self recoverable, No damage
<b>Noise emission according to EN 6100-6-3</b>		
• Emitted radio interface		EN55011 (EN55022) CLASS B <sup>5</sup>
• Radio interference voltage		EN55011 (EN55022) CLASS B <sup>5</sup>
<p>EN55011 corresponds to CISPR11 / EN55022 corresponds to CISPR22 / EM 61000 corresponds to IEC 1000</p> <p>1) Criterion A: Normal operating behavior within the defined limits.</p> <p>2) Criterion B: Temporary impairment to operational behavior that is corrected by the device itself.</p> <p>3) Symmetrical: Conductor to conductor.</p> <p>4) Asymmetrical: Conductor to ground.</p> <p>5) Class B: Area of application industry and residential.</p>		

# Numbering for Panel Mount Power Supply

For example: **PMC-12V050W1AA**

XX X XXXX XXXX X XX

**XX.....Product Type**

PM	Panel Mount
----	-------------

XX X XXXX XXXX X XX

**X.....Model**

C	Enclose Power Supply
---	----------------------

XX X XXXX XXXX X XX

**XXXX.....Voltage**

12V	12 Voltage
-----	------------

XX X XXXX XXXX X XX

**XXXX.....Watt**

035W	35 Watt
050W	50 Watt
100W	100 Watt

XX X XXXX XXXX X XX

**X.....Phase**

1	1 Phase
3	3 Phase

XX X XXXX XXXX X XX

**XX.....Variation (Eg, Customer, material,Etc.)**

AA	Delta standard – product
----	--------------------------

## Block Diagrams/Connections:

Block Diagram of Power Supply,

- PMC-12V050W1AA

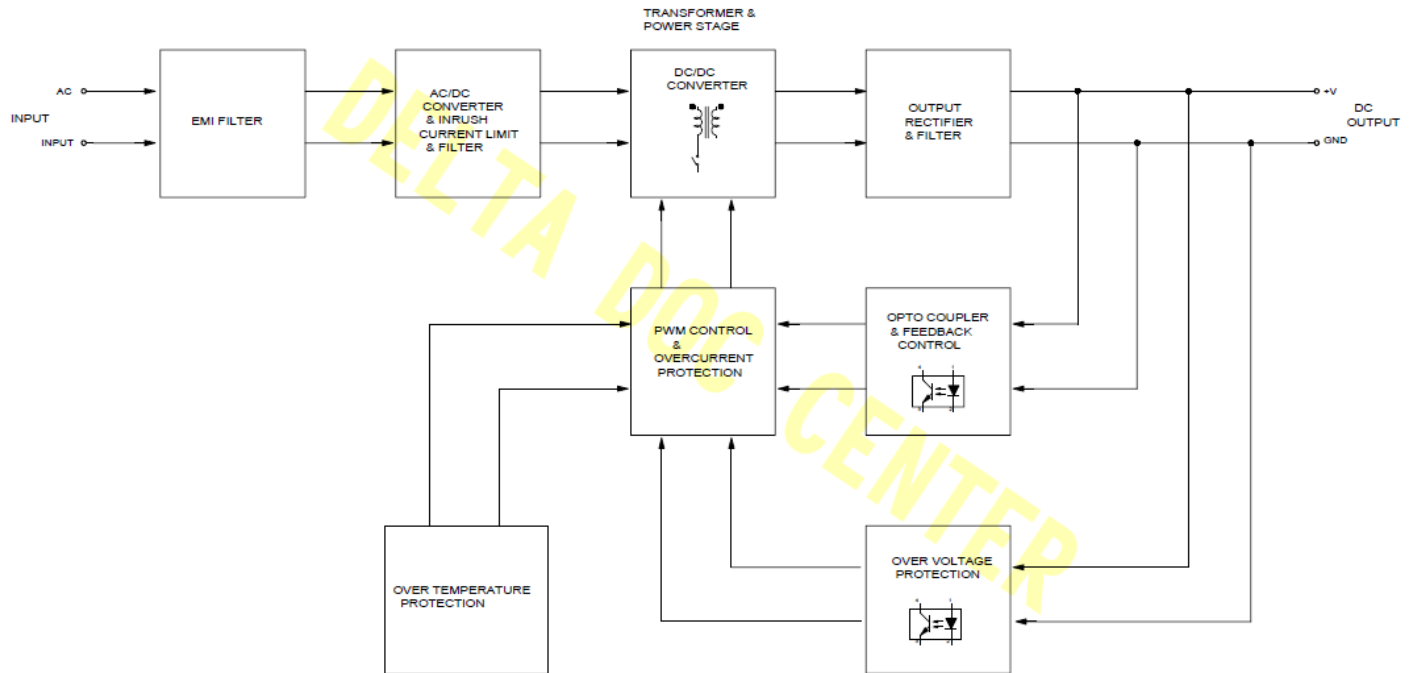

## Engineering Data

- **Derating Curve**
- **Model: PMC-12V050W1AA**

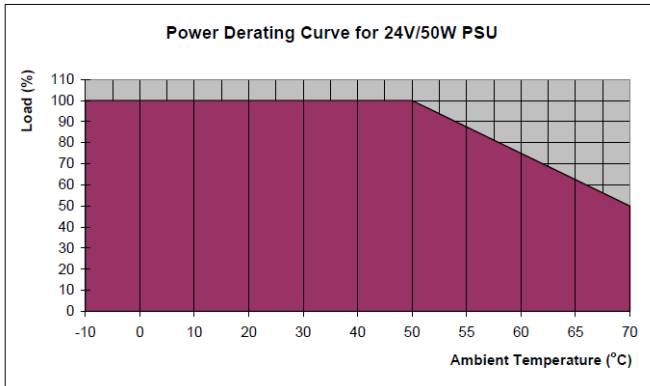

### Note:

1. Do not use the Power Supply in areas outside the shaded portion as shown in the above graph, internal parts may occasionally deteriorate or be damaged.
2. For the power derating refer above graph ambient temperature  $> 50^{\circ}\text{C}$ , the output capacity has to be reduced by 2.5% per Kelvin increase in temperature. If the output capacity is not reduced when  $\text{Amb} > 50^{\circ}\text{C}$  device will run into thermal protection by switching off i.e. device will go in bouncing mode and will recover when  
Amb is lowered or load is reduced as far as necessary to keep device in working condition.
3. If the power supply has to be mounted in any other direction please contact your service provider.
4. In order for the device to function in the manner intended, it is also necessary to observe lateral spacing of 2 cm to other modules.
5. Depending on the ambient temperature and load of the device, the temperature of the housing can become very high!

# Mechanical drawing

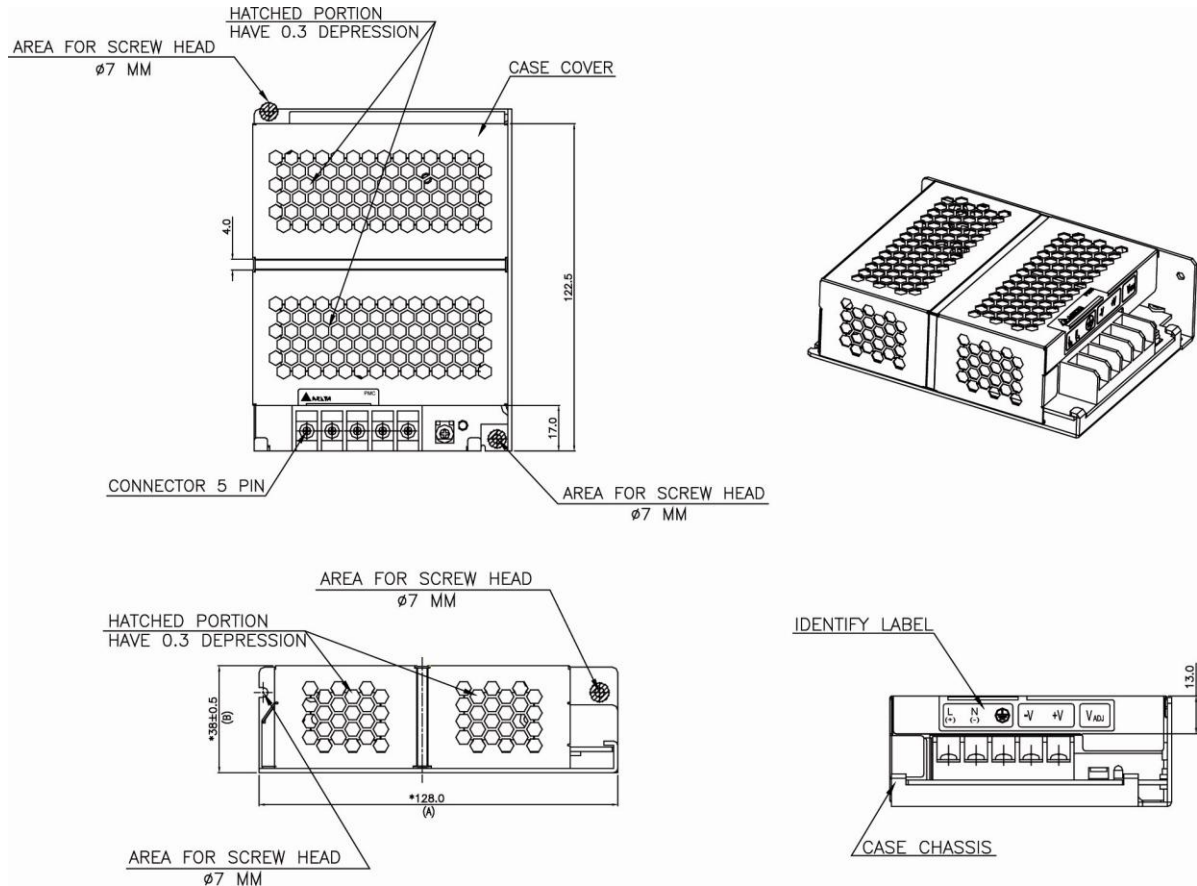

## Device description (Fig. 1)

- ① Input & Output terminal block connector
- ② DC voltage adjustment potentiometer
- ③ DC OK control LED (green)

Side Mounting (Vertical)

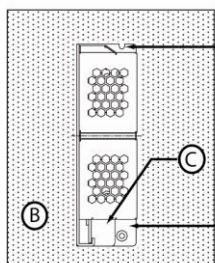

Base Mounting

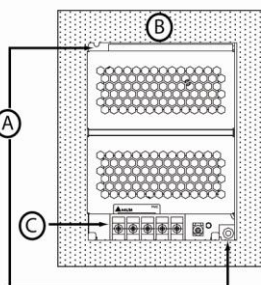

Side Mounting (Horizontal)

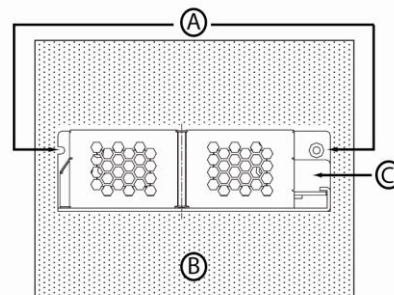

- **Over Load Protection**

The Power Supply is provided with an overload protection (OLP/OCP) function which protects the power supply from possible damage by over current. Additionally power supply also has over temperature protection (OTP) in case the over load condition persists for a longer duration and is below the overload trigger point but  $> 100\%$  load.

Typically the over load current ( $I_{OL}$ ) is  $> I_{SURGE}$  (120%) output voltage will start drooping down when the power supply reaches max power limit and will run into bouncing mode when the output reaches UVLO (under voltage point). The output voltage will recover automatically when the overload condition is removed.

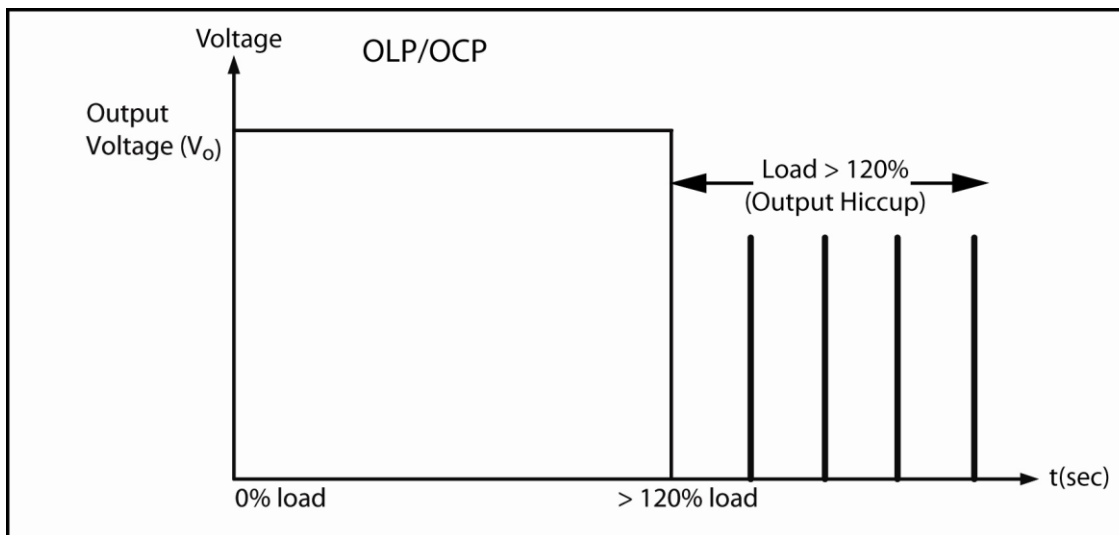

- **Short Circuit Protection**

The Power Supply also has a short circuit protection which is in line with the overload protection and activates whenever there is a short across the output voltage, output goes in bouncing mode and remains until the fault is removed.

- **Over Temperature Protection**

Additionally power supply also has over temperature protection (OTP) as mentioned above this OTP comes into picture when the over load condition persists for a longer duration and the output current level is below the overload trigger point but  $> 100\%$  load.

Also in the event of a higher ambient operating condition with 100% load the power supply will run into OTP when the Ambient temperature is  $> 55^\circ\text{C}$ . The protection is self recoverable when activated output voltage bounces until the operating ambient temperature of the power supply is reduced or the power supply is used within its power derating curve.



- **Over Voltage protection**

The Power Supply is protected by Over voltage in the event that power supply feedback circuit fails the output voltage will not be **> 16V +10%** under any Line/Load and operating ambient conditions.

The unique feature about this over voltage protection (OVP) is that power supply doesn't shut down but goes **Hicc-up mode (Auto recovery) which is 16V +10%, -5%**. The power supply output voltage will recover back to 12Vdc once the fault condition is removed.

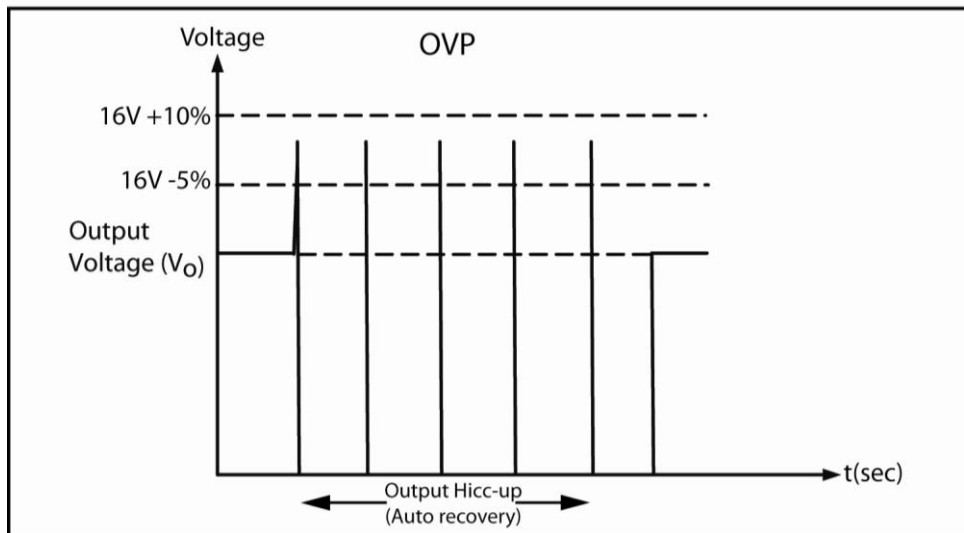

- **Inrush Current, Start Up Time, Output Hold Up Time**

**Inrush Current,**

Inrush current is the first surge current seen on the input side when AC input is applied to the power supply. It is the first pulse captured; see a typical picture for the Inrush current as seen in the power supply.

**Start Up Time,**

Start up time is measured from the point AC input is applied and the o/p voltage reaches within 90% of its set value. See picture below for a typical start up time characteristic of a power supply.

### Rise Time,

Rise time is the time needed for o/p voltage to rise from 10% of its set value to 90% of its set value. See the picture below for a typical rise time measurement in a power supply.

### Hold Up Time,

Hold time is the time when the AC input collapses and o/p voltage retains regulation for a certain period of time is called as hold up time. See in the picture below a typical hold up time characteristic of a power supply. The hold time is measured until the o/p voltage remains in regulation hence it measured until the o/p voltage reaches 95% of its set value.

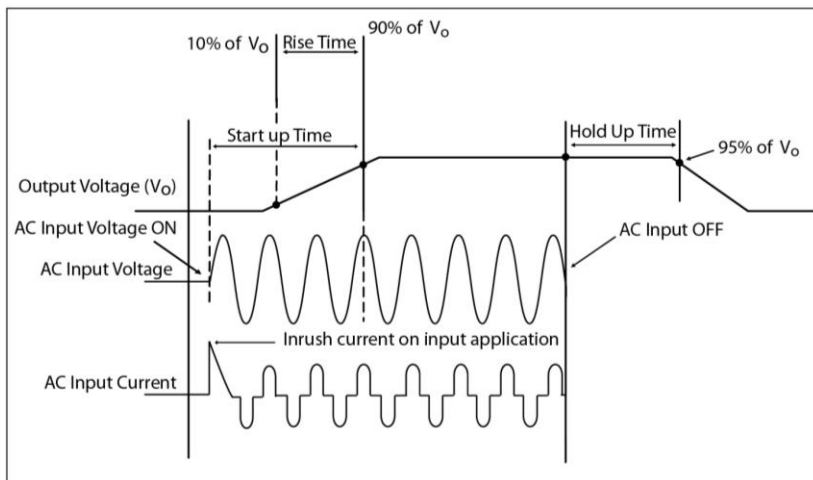

- **Output Voltage Adjust**

The 12VDC connection is made using the "+" and "-" screw connections. At the time of delivery, the output voltage is 12VDC. The output voltage can be set from 11 to 14VDC on the potentiometer seen as Adjust on the front panel of each power supply.

- **Dynamic Load**

Additionally power supply is capable of dynamic change of load from 0% to 100% with o/p voltage within  $\pm 5\%$  of regulation limits. See below the dynamic behavior of the PSU.

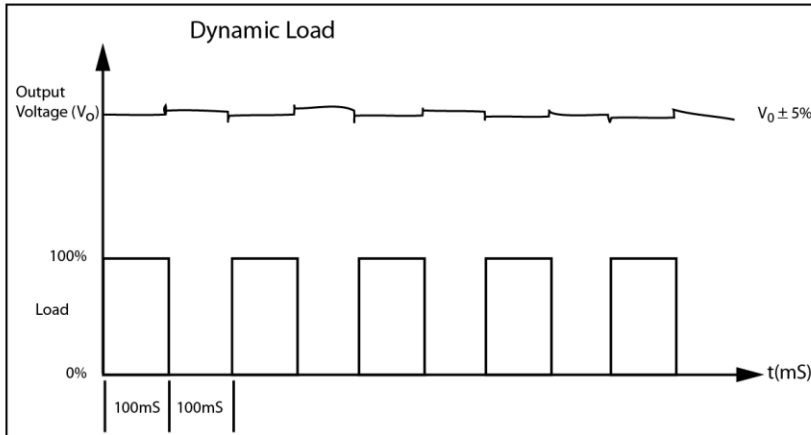

- **Redundancy & Parallel Operation with Oring Diode**

See below figure for a typical Redundant/Parallel operation of PSU using CliQ series power supplies. The 2 power supplies PSU1 & PSU2 are connected thru a twin diode where Anode1 A1 is connected to the +Ve i.e. 12V of PSU1 and Anode2 A2 is connected to the +Ve i.e. 12V of PSU2 and the output ground GND are shorted together.

The output of these 2 power supplies PSU1 & PSU2 is drawn from the Cathode K of the twin diode thus making the power supply work in Redundant/Parallel operation.

**Redundant Operation:**

When 2 power supplies are connected in below manner the power supply PSU1 or PSU2 whichever has higher output voltage takes the max load and the other PSU is operating in standby (@No Load) in case of failure on PSU1, PSU2 takes over the load from PSU1 and supplies the required power to end system.

- Redundant / Parallel Operation with External Oring Diode

Redundance / Parallel Operation with External Oring Diode

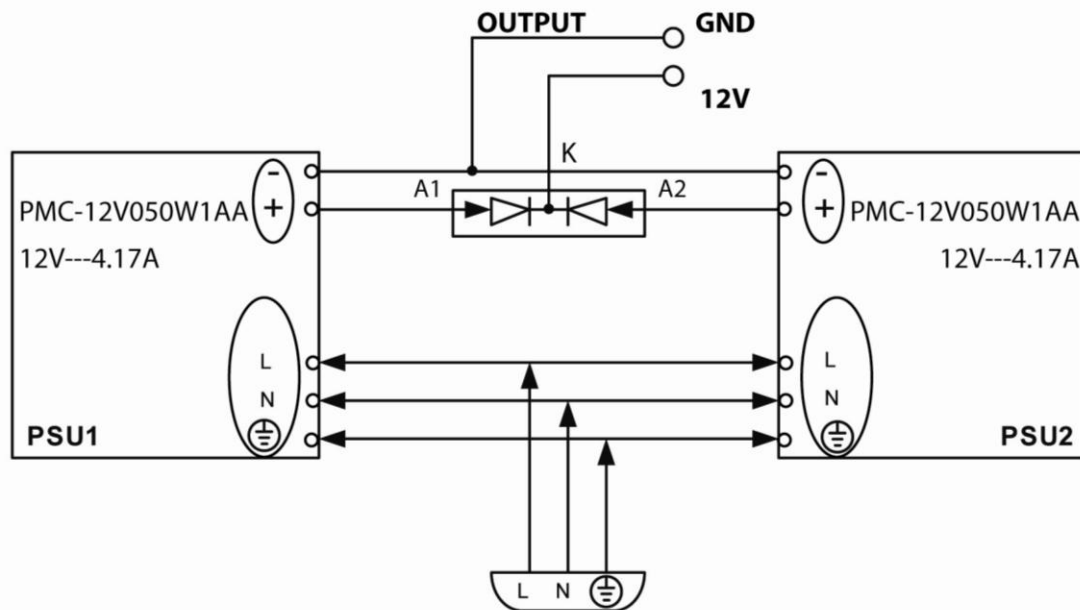
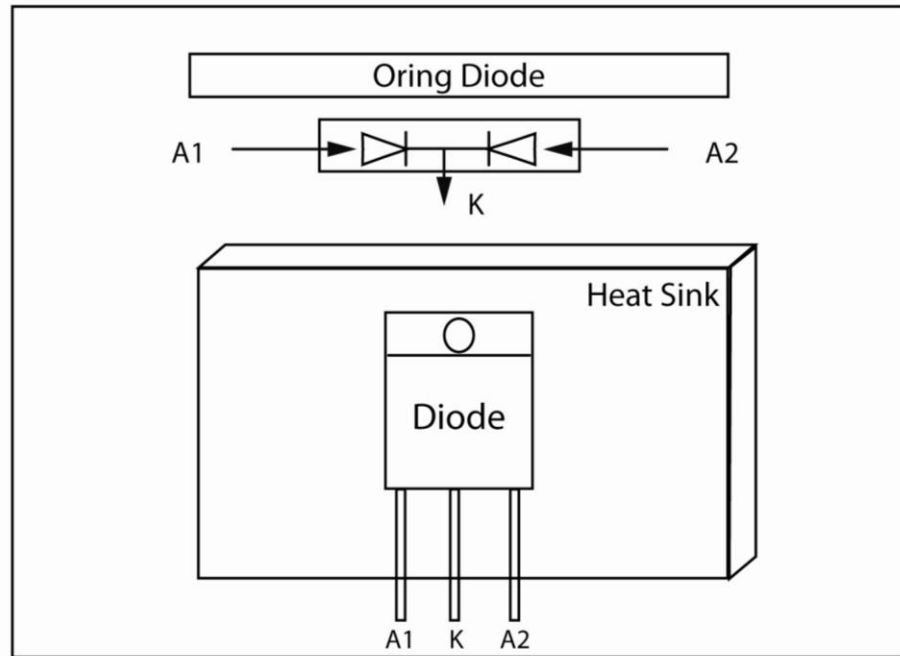

**Parallel Operation:**

When 2 power supplies are also connected in the above manner they can share the Load provided following steps are taken.

**Step 1:**

Measure the o/p voltages @ NL measured from A1 to Gnd i.e. VA1 to Gnd of PSU1 and VA2 to Gnd of PSU2. If the voltages are not same follow step 2, if the o/p voltages are same skip step 2 and move to step 3.

**Step 2:**

Adjust the o/p voltages with the help of VR available on the front panel of the PSU marked as ADJUST for both PSU1 and PSU2 at the same level for e.g. if PSU1 o/p is measuring 12.15Vdc and PSU2 is measuring 12.25Vdc adjust the o/p voltage of either PSU1 close to 12.25Vdc or adjust the o/p voltage of PSU2 close to 12.15Vdc.

**Step 3:**

Connect the PSU to the end system load and measure the o/p voltages from A1 to Gnd i.e. VA1 to Gnd of PSU1 and VA2 to Gnd of PSU2. Ensure that o/p voltages are same even after the 2 power supplies are connected to load. If not then adjust them with the VR available on Front panel. A tolerance of  $\pm 25\text{mV}$  would be acceptable.

**Note:**

1. If the o/p voltage of any 1 power supply i.e. PSU1 or PSU2 is higher that power supply will take the initial load and also share the maximum load.
2. If the o/p voltages adjusted are same then an equal load current sharing between the 2 power supplies can be achieved.
3. The Oring diode must be of an appropriate rating, recommended rating of Oring Diode is minimum 4 times of the output load current and minimum reverse voltage rating of 45Vrr.
4. A suitable HS is also advised to ensure that oring Diode is not over heated and damaged.